

Industrial connectivity solutions

Industrial Connectivity Solutions

WARNINGS

The characteristics of the products contained in this catalogue are not binding for Cabur and can be changed, without prior notice, due to production requirements or to improve the products. Hence, please contact our technical-commercial network for any necessary confirmations or updates. You can find additional information about this and other Cabur products at our website www.cabur.eu

The Company

Founded in Italy in 1952, Cabur quickly conquered the role of leader amongst the national manufacturers of terminal blocks for electrical panels, always paying particular attention to the needs of installers and to cutting-edge technological solutions.

Today the company develops and manufactures a wide range of products for the electrotechnical and electronic industry which are renowned for their reliability even in extreme conditions of use.

The current production is the result of the many years of experience gained by Cabur as a partner of the main national bodies and companies, perfected through actions and collaborations abroad and includes:

- Connections for electrical panels
- Automation and control solutions
- Industrial marking systems
- Solutions for energy transition

The wide and diversified offer guarantees a level of flexibility and unique ability to find solutions tailored to specific needs, which enables us to respond to the most varied and complex installation needs.

Always oriented towards the improvement of its products, in recent years Cabur has responded to the Industry 4.0 project with the expansion of production facilities and important product innovations.

In pursuing a corporate culture based on Total Quality, Cabur has adopted the main European directives of the reference market and collaborates with the most prestigious national and foreign Institutes and Laboratories.

Its products are the result of qualitative choices of particular relevance in the field of raw materials used that, in addition to providing an ample guarantee of functionality and reliability over time, also work in full compliance with all the Norms, Regulations, Laws and applicable requirements, binding and self-adopted, with full satisfaction of all compliance obligations.

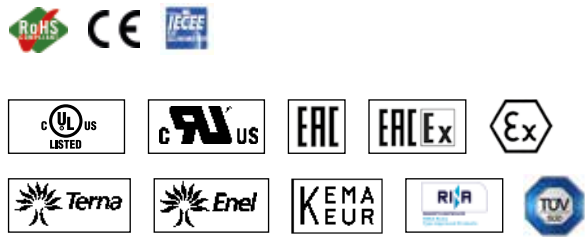

INDUSTRIAL CONNECTIVITY SOLUTIONS



AUTOMATION AND CONTROL SOLUTIONS



INDUSTRIAL MARKING SOLUTIONS



SOLUTIONS FOR ENERGY TRANSITION

SPRING CLAMP TERMINAL BLOCKS WITH PUSH-IN TECHNOLOGY

FEED-THROUGH AND EARTH TERMINAL BLOCKS.....	13	FUSE-HOLDER TERMINAL BLOCKS.....	28
TWO LEVELS FEED-THROUGH AND EARTH TERMINAL BLOCKS.....	19		
DISCONNECT TERMINAL BLOCKS.....	25		
THREE LEVELS TERMINAL BLOCKS.....	26		
TWO LEVELS DISCONNECT TERMINAL BLOCKS.....	27		

SPRING CLAMP TERMINAL BLOCKS

FEED-THROUGH TERMINAL BLOCKS.....	33	TERMINAL BLOCKS WITH SPECIAL CONNECTIONS.....	55
EARTH TERMINAL BLOCKS.....	39	MINI TERMINAL BLOCKS.....	56
TWO LEVELS TERMINAL BLOCKS.....	43		
THREE LEVELS TERMINAL BLOCKS.....	48		
TERMINAL BLOCKS FOR TEST AND MEASUREMENT.....	50		
FUSE-HOLDER TERMINAL BLOCKS.....	51		

SCREW CLAMP TERMINAL BLOCKS

FEED-THROUGH AND EARTH TERMINAL BLOCKS.....	61	DIODE HOLDER TERMINAL BLOCKS.....	118	MULTI-POLE TERMINAL BLOCKS.....	137
TWO LEVELS TERMINAL BLOCKS.....	96	TERMINAL BLOCKS WITH ELECTRONIC COMPONENTS..	119		
THREE LEVELS TERMINAL BLOCKS.....	101	TERMINAL BLOCKS WITH SPECIAL CONNECTIONS.....	130		
FUSE HOLDER TERMINAL BLOCKS.....	103	TERMINAL BLOCKS FOR THERMOCOUPLES.....	133		
DISCONNECT TERMINAL BLOCKS.....	110	DISCONNECT LEVER TERMINAL BLOCKS.....	134		
FOR TEST AND MEASUREMENT TERMINAL BLOCKS.....	116	MINI TERMINAL BLOCKS.....	135		

DISTRIBUTION TERMINAL BOARDS

MZ DISCONNECT TERMINAL BOARD.....	142	CAMUT 12 POLES TERMINAL STRIPS.....	153
QBLOK DISTRIBUTION TERMINAL BOARDS.....	143	FJ FLYING SPRING CONNECTORS.....	154
POLM DISTRIBUTION TERMINAL BOARDS.....	150		
CONT TERMINAL BLOCKS.....	151		
CONTC TERMINAL BLOCKS.....	152		

ACCESSORIES

TERMINAL BLOCKS END SECTIONS.....	158	MODULAR TEST PLUGS.....	175	PROTECTION COVERS.....	182
END BRACKETS.....	159	SOCKETS AND PLUGS.....	176	WARNING PLATES.....	183
TAG HOLDER FOR DIN RAIL.....	160	COMPONENT HOLDER.....	177	TAG HOLDER FOR TERMINAL BLOCKS.....	184
MOUNTING RAILS.....	161	SPECIFIC ACCESSORIES.....	178	SCREWDRIVERS.....	185
ACCESSORIES FOR MOUNTING RAILS.....	162	FUSES.....	179	FERRULE.....	186
CROSS CONNECTIONS.....	166	PARTITIONS.....	180		

INDUSTRIAL MARKING SYSTEM (EXTRACT FROM THE CATALOGUE)

SMARTPRINT SYSTEM.....	190
SMARTROLL SYSTEM.....	191
CABURJET SYSTEM.....	192
PRE-PRINTED TAGS FOR CABUR TERMINAL BLOCKS.....	193
PERSONALIZED PRINTING SERVICE.....	196

SPRING-CLAMP TERMINAL BLOCKS WITH PUSH-IN TECHNOLOGY

FEED-THROUGH AND EARTH TERMINAL BLOCKS

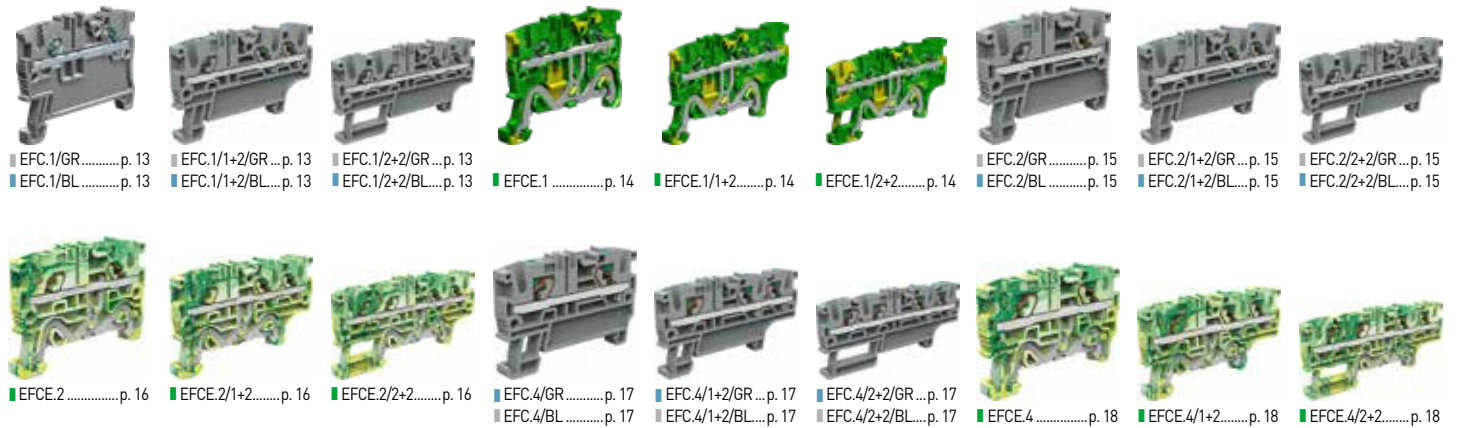

TWO LEVELS FEED-THROUGH AND EARTH TERMINAL BLOCKS

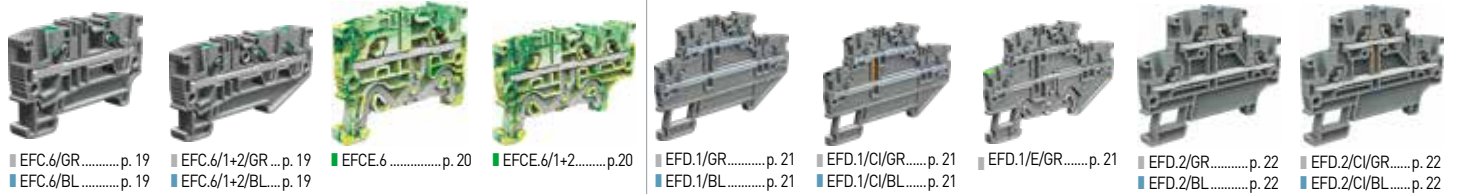

DISCONNECT TERMINAL BLOCKS



THREE LEVELS TERMINAL BLOCKS

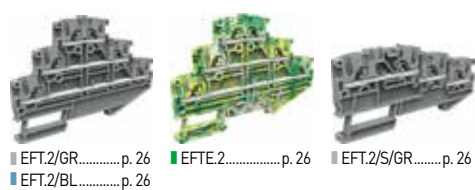

TWO LEVELS DISCONNECT TERMINAL BLOCKS



FUSE HOLDER TERMINAL BLOCKS



SPRING CLAMP TERMINAL BLOCKS

FEED-THROUGH TERMINAL BLOCKS

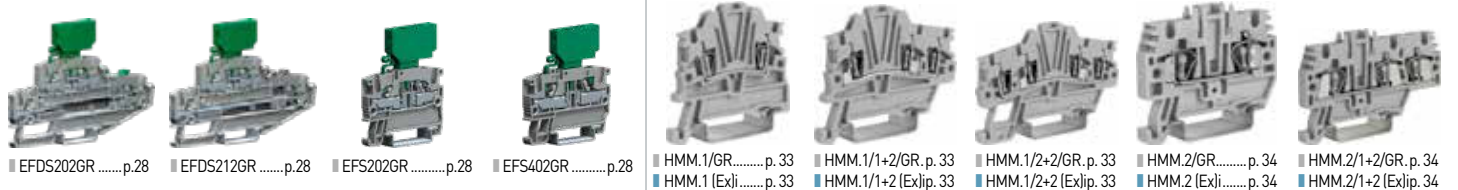

DISCONNECT TERMINAL BLOCKS



FEED-THROUGH TERMINAL BLOCKS



EARTH TERMINAL BLOCKS



■ HMM.16/GR.....p. 37 ■ HMR.16/GR.....p. 38 ■ HMR.16/D/GR...p. 38 ■ HTE.1.....p. 39 ■ HTE.1/1+2.....p. 39 ■ HTE.1/2+2.....p. 39 ■ HTE.2.....p. 40 ■ HTE.2/1+2.....p. 40 ■ HTE.2/2+2.....p. 40
 ■ HMM.16 [Ex]i.....p. 37

EARTH TERMINAL BLOCKS

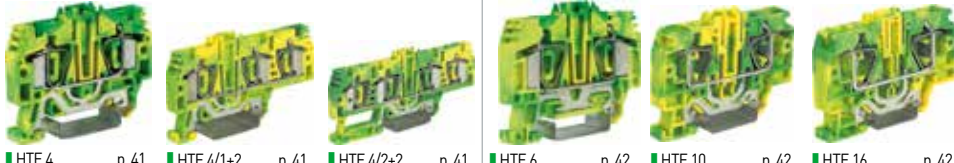

■ HTE.4.....p. 41 ■ HTE.4/1+2.....p. 41 ■ HTE.4/2+2.....p. 41 ■ HTE.6.....p. 42 ■ HTE.10.....p. 42 ■ HTE.16.....p. 42

TWO LEVELS TERMINAL BLOCKS



■ HMD.1/GR.....p. 43 ■ HMD.1/C/GR...p. 43 ■ HMD.2N/GR.....p. 44
 ■ HMD.1 [Ex]i.....p. 43 ■ HMD.2N [Ex]i.....p. 44

THREE LEVELS TERMINAL BLOCKS



■ HMD.2N/C/GR...p. 44 ■ HMD.2/GR.....p. 45 ■ HMD.1/X/GR.....p. 46 ■ HMD.2N/X/GR...p. 46 ■ HMD.2N/X1/GR p. 46 ■ HMD.2N/DD/GRp. 47 ■ HMD.2/3DC/GR p. 47 ■ HLD.2/GR.....p. 48 ■ HLD.2/C/GR.....p. 48
 ■ HLD.2 [Ex]i.....p. 48

TERMINAL BLOCKS FOR TEST AND MEASUREMENTS



■ HDE.2/GR.....p. 48 ■ HTTE.2.....p. 49 ■ HMS.2/GR.....p. 50 ■ HSCB.4/GR.....p. 50 ■ HSCB.6/GR.....p. 50

FUSE-HOLDER TERMINAL BLOCKS



■ HMFA.2/GR.....p. 51 ■ HFR.4/M/GR.....p. 52 ■ HFR.4/GR.....p. 52

TERMINAL BLOCKS FOR CONNECTORS



■ HCD.1/GR.....p. 53 ■ HVPC.2/GR.....p. 54 ■ CHP.2/GR.....p. 54 ■ CHP.2D/GR.....p. 54 ■ HVTE.2.....p. 55 ■ CHTE.2.....p. 55 ■ CHTE.2D.....p. 55
 ■ HCD.1 [Ex]i.....p. 53 ■ HVPC.2 [Ex]i.....p. 54 ■ CHP.2 [Ex]i.....p. 54 ■ CHP.2D [Ex]i.....p. 54

MINI TERMINAL BLOCKS



■ HPP.2/GR.....p. 56 ■ HP.2/GR.....p. 56 ■ HPC.2/GR.....p. 57
 ■ HPP.2 [Ex]i.....p. 56 ■ HP.2 [Ex]i.....p. 56 ■ HPC.2 [Ex]i.....p. 57

SCREW CLAMP TERMINAL BLOCKS

FEED-THROUGH TERMINAL BLOCKS - CBC SERIES

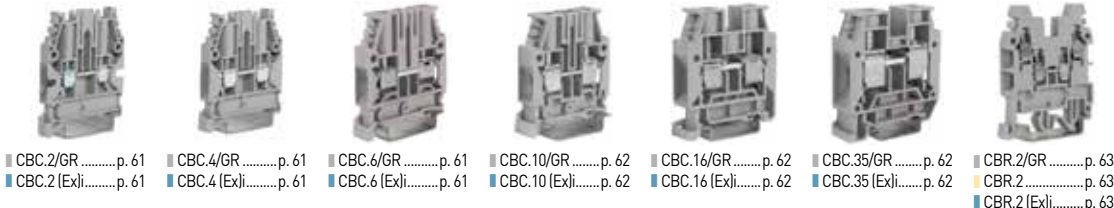

■ CBC.2/GR.....p. 61 ■ CBC.4/GR.....p. 61 ■ CBC.6/GR.....p. 61 ■ CBC.10/GR.....p. 62 ■ CBC.16/GR.....p. 62 ■ CBC.35/GR.....p. 62 ■ CBR.2/GR.....p. 63
 ■ CBC.2 [Ex]i.....p. 61 ■ CBC.4 [Ex]i.....p. 61 ■ CBC.6 [Ex]i.....p. 61 ■ CBC.10 [Ex]i.....p. 62 ■ CBC.16 [Ex]i.....p. 62 ■ CBC.35 [Ex]i.....p. 62 ■ CBR.2.....p. 63
 ■ CBR.2 [Ex]i.....p. 63

HIGH CURRENT TERMINAL BLOCKS - GPA SERIES



■ GPA.70/GR.....p. 64 ■ GPA.70/FIX/GR..p. 64 ■ GPA.95/GR.....p. 65 ■ GPA.95/FIX/GR..p. 65 ■ GPA.150/GR.....p. 66 ■ GPA.150/FX/GR p. 66 ■ GPA.240/GR.....p. 67 ■ GPA.240/FIX/GR p. 67
 ■ GPA.70.....p. 64 ■ GPA.70/FIX.....p. 64 ■ GPA.95.....p. 65 ■ GPA.95/FIX.....p. 65 ■ GPA.150.....p. 66 ■ GPA.150/FIX.....p. 66 ■ GPA.240.....p. 67 ■ GPA.240/FIX.....p. 67
 ■ GPA.70 [Ex]i.....p. 64 ■ GPA.95 [Ex]i.....p. 65

EARTH TERMINAL BLOCKS



■ TEC.6/0..... p. 68 ■ TEC.10/0..... p. 68 ■ TEC.16/0..... p. 68 ■ TEC.35/0..... p. 69 ■ TEC.70/0..... p. 69

FEED-THROUGH TERMINAL BLOCKS - CBD SERIES



■ CBD.2..... p. 73 ■ CBD.4..... p. 73 ■ CBD.6..... p. 73 ■ CBD.10..... p. 74 ■ CBD.16..... p. 74 ■ CBD.35..... p. 74 ■ CBD.50..... p. 75 ■ CBD.70..... p. 75
 ■ CBD.2 (ExI)..... p. 73 ■ CBD.4 (ExI)..... p. 73 ■ CBD.6 (ExI)..... p. 73 ■ CBD.10 (ExI)..... p. 74 ■ CBD.16 (ExI)..... p. 74 ■ CBD.35 (ExI)..... p. 74 ■ CBD.50 (ExI)..... p. 75 ■ CBD.70 (ExI)..... p. 75
 ■ CBD.50/GR..... p. 75 ■ CBD.70/GR..... p. 75

HIGH CURRENT TERMINAL BLOCKS - GPM SERIES

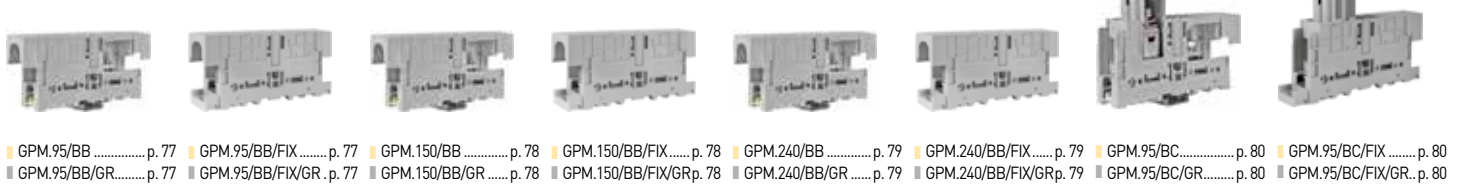

■ GPM.95/BB..... p. 77 ■ GPM.95/BB/FIX..... p. 77 ■ GPM.150/BB..... p. 78 ■ GPM.150/BB/FIX..... p. 78 ■ GPM.240/BB..... p. 79 ■ GPM.240/BB/FIX..... p. 79 ■ GPM.95/BC..... p. 80 ■ GPM.95/BC/FIX..... p. 80
 ■ GPM.95/BB/GR..... p. 77 ■ GPM.95/BB/FIX/GR..... p. 77 ■ GPM.150/BB/GR..... p. 78 ■ GPM.150/BB/FIX/GR..... p. 78 ■ GPM.240/BB/GR..... p. 79 ■ GPM.240/BB/FIX/GR..... p. 79 ■ GPM.95/BC/GR..... p. 80 ■ GPM.95/BC/FIX/GR..... p. 80

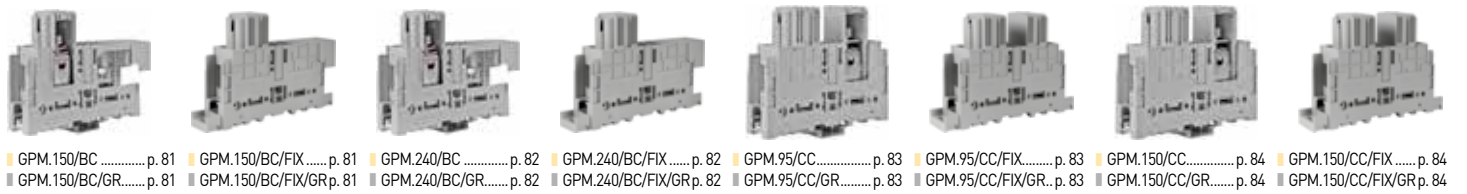

■ GPM.150/BC..... p. 81 ■ GPM.150/BC/FIX..... p. 81 ■ GPM.240/BC..... p. 82 ■ GPM.240/BC/FIX..... p. 82 ■ GPM.95/CC..... p. 83 ■ GPM.95/CC/FIX..... p. 83 ■ GPM.150/CC..... p. 84 ■ GPM.150/CC/FIX..... p. 84
 ■ GPM.150/BC/GR..... p. 81 ■ GPM.150/BC/FIX/GR..... p. 81 ■ GPM.240/BC/GR..... p. 82 ■ GPM.240/BC/FIX/GR..... p. 82 ■ GPM.95/CC/GR..... p. 83 ■ GPM.95/CC/FIX/GR..... p. 83 ■ GPM.150/CC/GR..... p. 84 ■ GPM.150/CC/FIX/GR..... p. 84

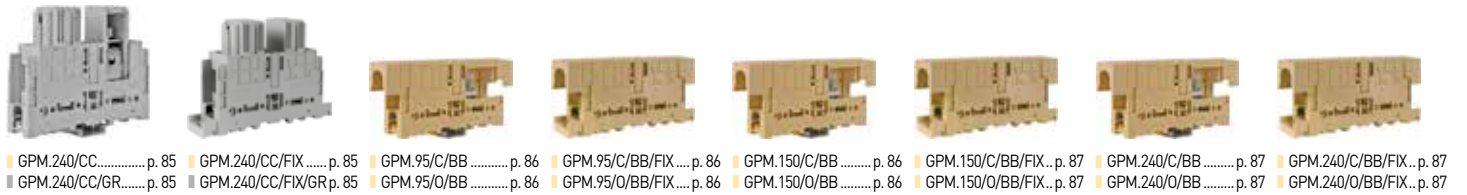

■ GPM.240/CC..... p. 85 ■ GPM.240/CC/FIX..... p. 85 ■ GPM.95/C/BB..... p. 86 ■ GPM.95/C/BB/FIX..... p. 86 ■ GPM.150/C/BB..... p. 86 ■ GPM.150/C/BB/FIX..... p. 87 ■ GPM.240/C/BB..... p. 87 ■ GPM.240/C/BB/FIX..... p. 87
 ■ GPM.240/CC/GR..... p. 85 ■ GPM.240/CC/FIX/GR..... p. 85 ■ GPM.95/O/BB..... p. 86 ■ GPM.95/O/BB/FIX..... p. 86 ■ GPM.150/O/BB..... p. 86 ■ GPM.150/O/BB/FIX..... p. 87 ■ GPM.240/O/BB..... p. 87 ■ GPM.240/O/BB/FIX..... p. 87

HIGH CURRENT TERMINAL BLOCKS ACB SERIES



■ ACB.70/BB..... p. 94 ■ ACB.120/BB..... p. 94 ■ ACB.185/BB..... p. 94

HIGH CURRENT TERMINAL BLOCKS - BCA SERIES



■ BCA.70/BB..... p. 89 ■ BCA.120/BB..... p. 89

HIGH CURRENT TERMINAL BLOCKS - MBL SERIES

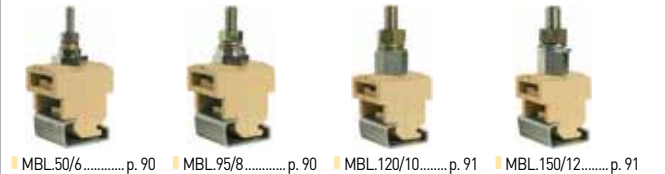

■ MBL.50/6..... p. 90 ■ MBL.95/8..... p. 90 ■ MBL.120/10..... p. 91 ■ MBL.150/12..... p. 91

EARTH TERMINAL BLOCKS



■ TE0.2..... p. 92 ■ CBE.2..... p. 92 ■ TE0.4..... p. 92 ■ TED.4..... p. 93 ■ TE.6/0..... p. 93 ■ TE.10/0..... p. 93 ■ TE.16/0..... p. 94 ■ TE.50/0..... p. 94

EARTH TERMINAL BLOCKS

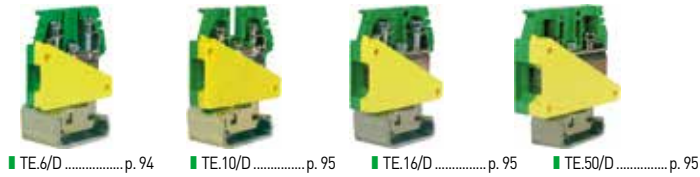

TE.6/D p. 94 TE.10/D p. 95 TE.16/D p. 95 TE.50/D p. 95

TWO LEVELS TERMINAL BLOCKS

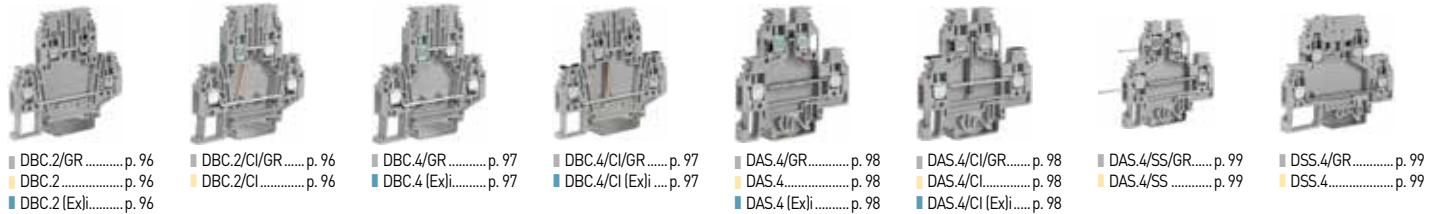

DBC.2/GR p. 96 DBC.2/CI/GR p. 96 DBC.4/GR p. 97 DBC.4/CI/GR p. 97 DAS.4/GR p. 98 DAS.4/CI/GR p. 98 DAS.4/SS/GR p. 99 DSS.4/GR p. 99
 DBC.2 p. 96 DBC.2/CI p. 96 DBC.4 (Ex)i p. 97 DBC.4/CI (Ex)i p. 97 DAS.4 p. 98 DAS.4/CI p. 98 DAS.4/SS p. 99 DSS.4 p. 99
 DBC.2 (Ex)i p. 96 DAS.4 (Ex)i p. 98 DAS.4/CI (Ex)i p. 98

THREE LEVELS TERMINAL BLOCKS

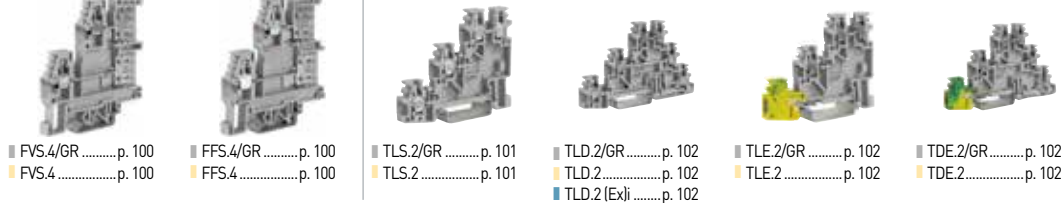

FVS.4/GR p. 100 FFS.4/GR p. 100 TLS.2/GR p. 101 TLD.2/GR p. 102 TLE.2/GR p. 102 TDE.2/GR p. 102
 FVS.4 p. 100 FFS.4 p. 100 TLS.2 p. 101 TLD.2 p. 102 TLE.2 p. 102 TDE.2 p. 102
 TLD.2 (Ex)i p. 102

FUSE-HOLDER TERMINAL BLOCKS

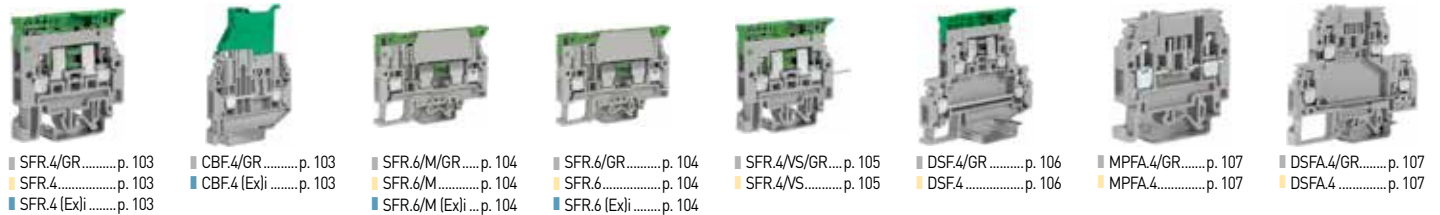

SFR.4/GR p. 103 CBF.4/GR p. 103 SFR.6/M/GR p. 104 SFR.6/GR p. 104 SFR.4/VS/GR p. 105 DSF.4/GR p. 106 MPFA.4/GR p. 107 DSFA.4/GR p. 107
 SFR.4 p. 103 CBF.4 (Ex)i p. 103 SFR.6/M p. 104 SFR.6 p. 104 SFR.4/VS p. 105 DSF.4 p. 106 MPFA.4 p. 107 DSFA.4 p. 107
 SFR.4 (Ex)i p. 103 SFR.6/M (Ex)i p. 104 SFR.6 (Ex)i p. 104

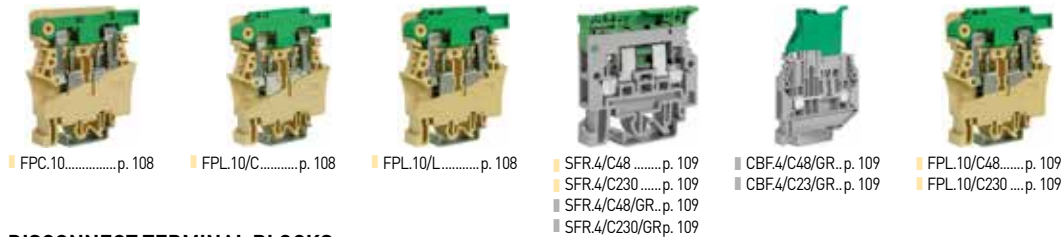

FPC.10 p. 108 FPL.10/C p. 108 FPL.10/L p. 108 SFR.4/C48 p. 109 CBF.4/C48/GR p. 109 FPL.10/C48 p. 109
 SFR.4/C230 p. 109 CBF.4/C23/GR p. 109 FPL.10/C230 p. 109
 SFR.4/C48/GR p. 109 SFR.4/C230/GR p. 109

DISCONNECT TERMINAL BLOCKS

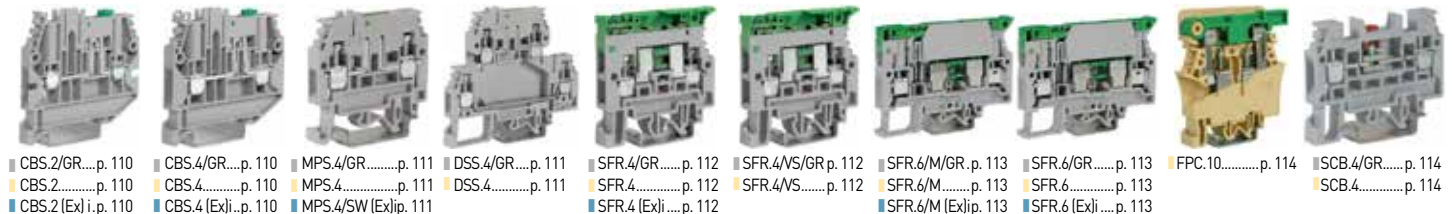

CBS.2/GR p. 110 CBS.4/GR p. 110 MPS.4/GR p. 111 DSS.4/GR p. 111 SFR.4/GR p. 112 SFR.4/VS/GR p. 112 SFR.6/M/GR p. 113 SFR.6/GR p. 113 FPC.10 p. 114 SCB.4/GR p. 114
 CBS.2 p. 110 CBS.4 p. 110 MPS.4 p. 111 DSS.4 p. 111 SFR.4 p. 112 SFR.4/VS p. 112 SFR.6/M p. 113 SFR.6 p. 113 SCB.4 p. 114
 CBS.2 (Ex)i p. 110 CBS.4 (Ex)i p. 110 MPS.4/SW (Ex)i p. 111 SFR.4 (Ex)i p. 112 SFR.6/M (Ex)i p. 113 SFR.6 (Ex)i p. 113

DISCONNECT TERMINAL BLOCKS

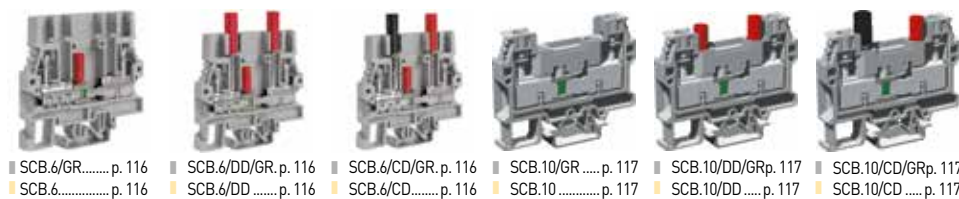

SCB.6/GR p. 116 SCB.6/DD/GR p. 116 SCB.6/CD/GR p. 116 SCB.10/GR p. 117 SCB.10/DD/GR p. 117 SCB.10/CD/GR p. 117
 SCB.6 p. 116 SCB.6/DD p. 116 SCB.6/CD p. 116 SCB.10 p. 117 SCB.10/DD p. 117 SCB.10/CD p. 117

DIODE-HOLDER TERMINAL BLOCKS

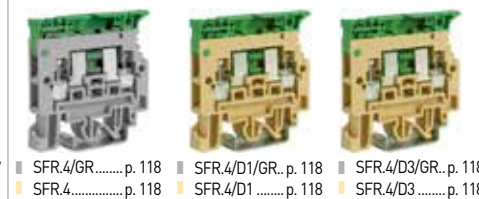

SFR.4/GR p. 118 SFR.4/D1/GR p. 118 SFR.4/D3/GR p. 118
 SFR.4 p. 118 SFR.4/D1 p. 118 SFR.4/D3 p. 118

TERMINAL BLOCKS WITH ELECTRONIC COMPONENTS

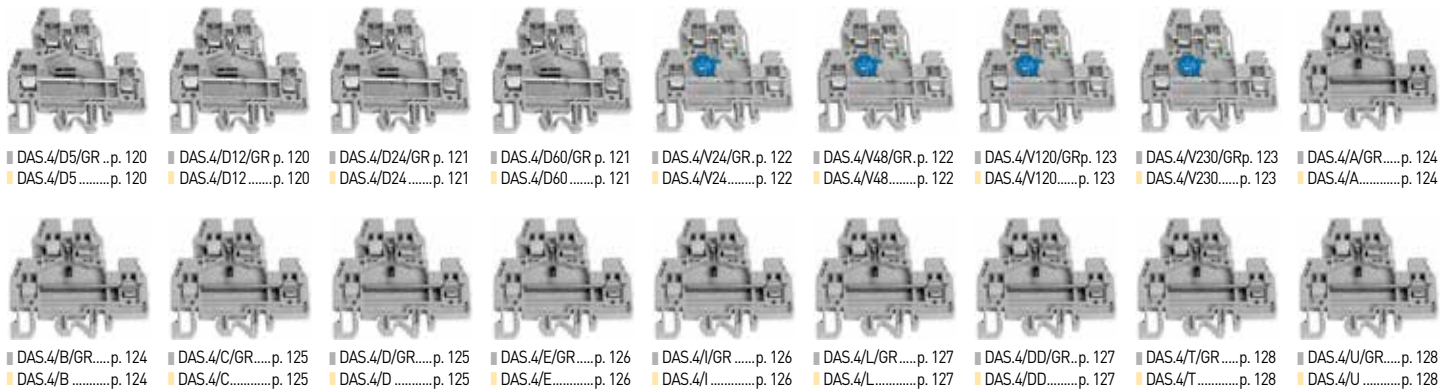

TERMINAL BLOCKS WITH SPECIAL CONNECTIONS AND FOR CONNECTORS

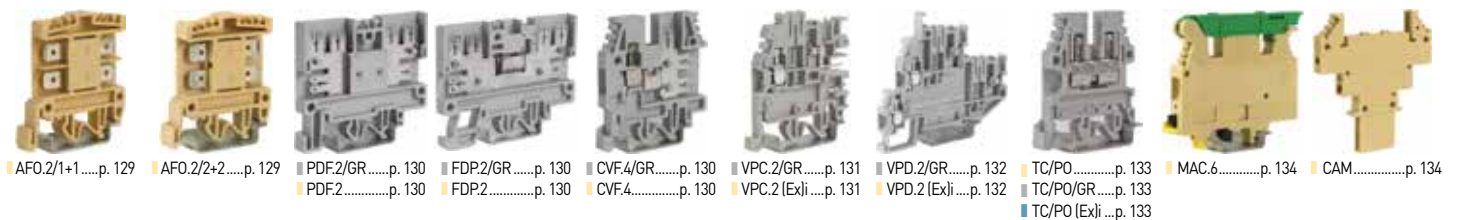

MINI TERMINAL BLOCKS

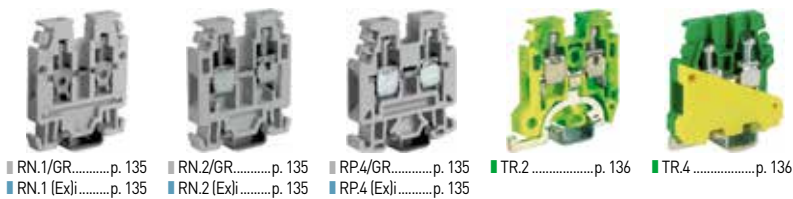

MODULAR MULTI POLE TERMINAL BLOCKS



DISTRIBUTION TERMINAL BOARDS



ACCESSORIESp. 155



Spring-Clamp Terminal Blocks with Push-In Technology

Cabur EFC:
Easy Fast Connection



IMQ 18 ATEX 007U	IECEx IMQ 18.0002U
I M2 Ex eb I Mb	Ex eb I Mb
II 2 G Ex eb IIC Gb	Ex eb IIC Gb

The new line of EFC products with Push-in connection technology offers a fast, reliable and efficient wiring of all cable types.

REDUCTION OF INSTALLATION TIME, INCREASED PERFORMANCE

The Push-in technology allows cables and hoses to be wired with or without wire clips. Cables are directly inserted in the terminal, with no tooling required to open the clamp spring: just pressing the wire is sufficient to provide a safe and durable electrical connection.

DIRECT PLUG-IN

Connection is so simple, precise and accurate that a switchboard can be wired with a single hand, without impacting performance. This also improves ergonomics. To connect flexible cables without a wire clip, just push the coloured button to open the spring clip and insert the properly stripped cable.

WIRE RELEASE BUTTONS: SPEED, SIMPLICITY AND SAFETY

To remove the wire from the terminal, just press the release button with any tool to open the spring. Release buttons, highlighted by different colours, prevent operators from making mistakes or coming into contact with potentially live parts, even in settings with a high concentration of links.



Speed

The Push-in technology helps reducing wiring times up to 75%.



Safety

An isolated button, identified with a different colour, protects the operator from indirect electrical contacts.



Quality

Having passed all the ATEX Directives, UL and EN60947-7 standards tests, these devices are suitable for any use and environment.



Simplicity

The stainless-steel spring designed by Cabur ensures optimal connection and prevents accidental removal.



Innovation

A compact and highly-visible design optimizes space in automation and control boards.



Efficiency

At last, one single hand is enough to wire an EFC series clamp, for a smoother workflow.

EFC.1 SERIES

SPRING CLAMP TERMINAL BLOCKS WITH PUSH-IN TECHNOLOGY



- Reduced wiring time
- Wire release button
- Reduced width

	IMQ 18 ATEX 007U	IECEx IMQ 18.0002U
	I M2 Ex eb I Mb	Ex eb I Mb
	II 2G Ex eb IIC Gb	Ex eb IIC Gb

(1) See chapter accessories for more details



GREY VERSION	CODE TYPE	EFC100GR	EFC.1/GR	EFC110GR	EFC.1/1+2/GR	EFC120GR	EFC.1/2+2/GR
BLUE VERSION	CODE TYPE	EFC100BL	EFC.1/BL	EFC110BL	EFC.1/1+2/BL	EFC120BL	EFC.1/2+2/BL

TECHNICAL CHARACTERISTICS

Function/type		Feed-through	Feed-through	Feed-through
Rated cross-section	(mm ²)	1,5	1,5	1,5
Connecting capacity	Flexible (mm ²)	0.2 ÷ 1.5	0.2 ÷ 1.5	0.2 ÷ 1.5
	Rigid (mm ²)	0.2 ÷ 1.5	0.2 ÷ 1.5	0.2 ÷ 1.5
	Max.flexible with ferrule - ferrule type (mm ²)	1.5 - WP15/14	1.5 - WP15/14	1.5 - WP15/14
Electrical characteristics According to European standard IEC EN 60947-7-1	Max AC/DC Voltage (V)	630	630	630
	Max current with rated cross-section (A)	17,5	17,5	17,5
	Section Caliber	A1 - B1	A1 - B1	A1 - B1
Electrical characteristics According to UL	Max AC/DC Voltage (V)	300	300	300
	Max current with rated cross-section (A)	15	15	15
	Section Min-Max (AWG)	26 - 14	26 - 14	26 - 14
Electrical characteristics According to ATEX directive and IEC ex standard	Max AC/DC Voltage (V)	440	440	440
	Max current with rated cross-section (A)	17	17	17
	Operating temperature (°C)	-40 +110	-40 +110	-40 +110
Rated impulse withstand voltage/pollution degree		6 kV / 3	6 kV / 3	6 kV / 3
Insulation stripping length (mm)		8	8	8
Width (mm)		3,5	3,5	3,5
Length (mm)		44,9	56,4	68
Height mounted on TH35/7,5 (mm)		36,5	36,5	36,5
Height mounted on TH35/15 (mm)		44	44	44
Insulation material temperature index (EN 60216-1) (°C)		130	130	130
Plastic material		Polyamide UL94 V-0	Polyamide UL94 V-0	Polyamide UL94 V-0

APPROVALS

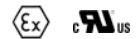

ACCESSORIES

End section	Grey	EFC.1/PT/GR (cod. EFC101GR)	EFC.1/1+2/PT/GR (cod. EFC111GR)	EFC.1/2+2/PT/GR (cod. EFC121GR)
	Blue	EFC.1/PT/BL (cod. EFC101BL)	EFC.1/1+2/PT/BL (cod. EFC111BL)	EFC.1/1+2/PT/BL (cod. EFC121BL)
Cross connection	Thickness (mm)	1,5	1,5	1,5
	[1] Rated current / Rated current ATEX applications (A)	EFB.1/.../... (cod. EFB01...)	EFB.1/.../... (cod. EFB01...)	EFB.1/.../... (cod. EFB01...)
Coloured partition	red	DFE.1+1/R (cod. DFE01R)	DFE.1+2/R (cod. DFE02R)	DFE.2+2/R (cod. DFE03R)
105mm adhesive numbering strip		TMM102105AW (cod. TMM102105AW)	TMM102105AW (cod. TMM102105AW)	TMM102105AW (cod. TMM102105AW)
105mm snap numbering strip		TMM102105W (cod. TMM102105W)	TMM102105W (cod. TMM102105W)	TMM102105W (cod. TMM102105W)
Single marking tag		CNU/8/35 (cod. NU0835S)	CNU/8/35 (cod. NU0835S)	CNU/8/35 (cod. NU0835S)
Single marking tag for pitch insert		CNU/10/35 (cod. NU1035S)	CNU/10/35 (cod. NU1035S)	CNU/10/35 (cod. NU1035S)
End bracket	Screw TH35	BT/3 (cod. BT003)	BT/3 (cod. BT003)	BT/3 (cod. BT003)
	Snap-fit TH35	BT0 (cod. BT007)	BT0 (cod. BT007)	BT0 (cod. BT007)

EFCE.1 SERIES

SPRING CLAMP EARTH TERMINAL BLOCKS WITH PUSH-IN TECHNOLOGY



- Reduced wiring time
- Wire release button
- Reduced width



	IMQ 18 ATEX 007U	IECEx IMQ 18.0002U
	I M2 Ex eb I Mb	Ex eb I Mb
	II 2G Ex eb IIC Gb	Ex eb IIC Gb

(1) See chapter accessories for more details

YELLOW/GREEN VERSION		CODE	EFCE100	EFCE110	EFCE120
		TYPE	EFCE.1	EFCE.1/1+2	EFCE.1/2+2
TECHNICAL CHARACTERISTICS					
Function/type			Earth terminal block	Earth terminal block	Earth terminal block
Rated cross-section		[mm ²]	1,5	1,5	1,5
Connecting capacity	Flexible	[mm ²]	0.2 ÷ 1.5	0.2 ÷ 1.5	0.2 ÷ 1.5
	Rigid	[mm ²]	0.2 ÷ 1.5	0.2 ÷ 1.5	0.2 ÷ 1.5
	Max.flexible with ferrule - ferrule type	[mm ²]	1.5 - WP15/14	1.5 - WP15/14	1.5 - WP15/14
Electrical characteristics According to European standard IEC EN 60947-7-2	Max AC/DC Voltage	[V]	-	-	-
	Max current with rated cross-section	[A]	-	-	-
	Section	Caliber	A1 - B1	A1 - B1	A1 - B1
Electrical characteristics According to UL	Max AC/DC Voltage	[V]	-	-	-
	Max current with rated cross-section	[A]	-	-	-
	Section Min-Max	[AWG]	26 - 14	26 - 14	26 - 14
Electrical characteristics According to ATEX directive and IEC ex standard	Max AC/DC Voltage	[V]	-	-	-
	Max current with rated cross-section	[A]	-	-	-
	Operating temperature	[°C]	-40 +110	-40 +110	-40 +110
Rated impulse withstand voltage/pollution degree			6 kV / 3	6 kV / 3	6 kV / 3
Insulation stripping length		[mm]	8	8	8
Width		[mm]	3,5	3,5	3,5
Length		[mm]	48,4	60	68
Height mounted on TH35/7,5		[mm]	36,5	36,5	36,5
Height mounted on TH35/15		[mm]	44	44	44
Insulation material temperature index (EN 60216-1)		[°C]	130	130	130
Plastic material			Polyamide UL94 V-0	Polyamide UL94 V-0	Polyamide UL94 V-0

APPROVALS

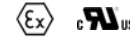

ACCESSORIES			EFCE100	EFCE110	EFCE120
End section	Grey		EFC.1/PT/GR (cod. EFC101GR)	EFC.1/1+2/PT/GR (cod. EFC111GR)	EFC.1/2+2/PT/GR (cod. EFC121GR)
	Blue		EFC.1/PT/BL (cod. EFC101BL)	EFC.1/1+2/PT/BL (cod. EFC111BL)	EFC.1/1+2/PT/BL (cod. EFC121BL)
	Thickness	[mm]	1,5	1,5	1,5
Cross connection	(1)		EFB.1/.../... (cod. EFB01...)	EFB.1/.../... (cod. EFB01...)	EFB.1/.../... (cod. EFB01...)
	Rated current / Rated current ATEX applications	[A]	17,5	17,5	17,5
Coloured partition	red		DFE.1+1/R (cod. DFE01R)	DFE.1+2/R (cod. DFE02R)	DFE.2+2/R (cod. DFE03R)
105mm adhesive numbering strip			TMM102105AW (cod. TMM102105AW)	TMM102105AW (cod. TMM102105AW)	TMM102105AW (cod. TMM102105AW)
105mm snap numbering strip			TMM102105W (cod. TMM102105W)	TMM102105W (cod. TMM102105W)	TMM102105W (cod. TMM102105W)
Single marking tag			CNU/8/35 (cod. NU0835S)	CNU/8/35 (cod. NU0835S)	CNU/8/35 (cod. NU0835S)
Single marking tag for pitch insert			CNU/10/35 (cod. NU1035S)	CNU/10/35 (cod. NU1035S)	CNU/10/35 (cod. NU1035S)
End bracket	Screw TH35		BT/3 (cod. BT003)	BT/3 (cod. BT003)	BT/3 (cod. BT003)
	Snap-fit TH35		BT0 (cod. BT007)	BT0 (cod. BT007)	BT0 (cod. BT007)

EFC.2 SERIES

SPRING CLAMP TERMINAL BLOCKS WITH PUSH-IN TECHNOLOGY



- Reduced wiring time
- Wire release button



IMQ 18 ATEX 007U
I M2 Ex eb I Mb
II 2G Ex eb IIC Gb

IECEx IMQ 18.0002U
Ex eb I Mb
Ex eb IIC Gb

(1) See chapter accessories for more details



EFC SPRING CLAMPS

GREY VERSION	CODE TYPE	EFC200GR	EFC.2/GR	EFC210GR	EFC.2/1+2/GR	EFC220GR	EFC.2/2+2/GR
BLUE VERSION	CODE TYPE	EFC200BL	EFC.2/BL	EFC210BL	EFC.2/1+2/BL	EFC220BL	EFC.2/2+2/BL

TECHNICAL CHARACTERISTICS

Function/type		Feed-through	Feed-through	Feed-through
Rated cross-section	(mm ²)	2.5	2.5	2.5
Connecting capacity	Flexible (mm ²)	0,2 ÷ 4	0,2 ÷ 4	0,2 ÷ 4
	Rigid (mm ²)	0,2 ÷ 4	0,2 ÷ 4	0,2 ÷ 4
	Max.flexible with ferrule - ferrule type (mm ²)	2,5 - WP25/19	2,5 - WP25/19	2,5 - WP25/19
Electrical characteristics According to European standard IEC EN 60947-7-1	Max AC/DC Voltage (V)	800	800	800
	Max current with rated cross-section (A)	24	24	24
	Section Caliber	A3	A3	A3
Electrical characteristics According to UL	Max AC/DC Voltage (V)	600	600	600
	Max current with rated cross-section (A)	20	20	20
	Section Min-Max (AWG)	24 - 12	24 - 12	24 - 12
Electrical characteristics According to ATEX directive and IEC ex standard	Max AC/DC Voltage (V)	500	500	500
	Max current with rated cross-section (A)	20	20	20
	Operating temperature (°C)	-40 +110	-40 +110	-40 +110
Rated impulse withstand voltage/pollution degree		6kV / 3	6kV / 3	6kV / 3
Insulation stripping length	(mm)	9	9	9
Width	(mm)	5.2	5.2	5.2
Length	(mm)	49.6	63.1	76.6
Height mounted on TH35/7,5	(mm)	39.2	39.2	39.2
Height mounted on TH35/15	(mm)	46.7	46.7	46.7
Insulation material temperature index (EN 60216-1)	(°C)	130	130	130
Plastic material		polyamide UL94V-0	polyamide UL94V-0	polyamide UL94V-0

APPROVALS



ACCESSORIES

End section	Grey	EFC.2/PT/GR (cod. EFC201GR)	EFC.2/1+2/PT/GR (cod. EFC211GR)	EFC.2/2+2/PT/GR (cod. EFC221GR)
	Blue	EFC.2/PT/BL (cod. EFC201BL)	EFC.2/1+2/PT/BL (cod. EFC211BL)	EFC.2/2+2/PT/BL (cod. EFC221BL)
Cross connection	Thickness (mm)	1.5	1.5	1.5
	[1] Rated current / Rated current ATEX applications (A)	EFB.2/.../... (cod. EFB02...)	EFB.2/.../... (cod. EFB02...)	EFB.2/.../... (cod. EFB02...)
Coloured partition	red	DfE.1+1/R (cod. DfE01R)	DfE.1+2/R (cod. DfE02R)	DfE.2+2/R (cod. DfE03R)
105mm adhesive numbering strip		TMM102105AW (cod. TMM102105AW)	TMM102105AW (cod. TMM102105AW)	TMM102105AW (cod. TMM102105AW)
105mm snap numbering strip		TMM102105W (cod. TMM102105W)	TMM102105W (cod. TMM102105W)	TMM102105W (cod. TMM102105W)
Single marking tag		CNU/10/51 (cod. NU1051S)	CNU/10/51 (cod. NU1051S)	CNU/10/51 (cod. NU1051S)
Single marking tag for pitch insert		CNU/10/51 (cod. NU1051S)	CNU/10/51 (cod. NU1051S)	CNU/10/51 (cod. NU1051S)
End bracket	Screw TH35	BT/3 (cod. BT003)	BT/3 (cod. BT003)	BT/3 (cod. BT003)
	Snap-fit TH35	BTO (cod. BT007)	BTO (cod. BT007)	BTO (cod. BT007)

- Reduced wiring time
- Wire release button

	IMQ 18 ATEX 007U	IECEx IMQ 18.0002U
	I M2 Ex eb I Mb	Ex eb I Mb
	II 2G Ex eb IIC Gb	Ex eb IIC Gb

(1) See chapter accessories for more details



YELLOW/GREEN VERSION	CODE TYPE	EFCE200	EFCE210	EFCE220
----------------------	-----------	---------	---------	---------

TECHNICAL CHARACTERISTICS

Function/type		Earth terminal blocks	Earth terminal blocks	Earth terminal blocks
Rated cross-section	[mm ²]	2,5	2,5	2,5
Connecting capacity	Flexible [mm ²]	0,2 ÷ 4	0,2 ÷ 4	0,2 ÷ 4
	Rigid [mm ²]	0,2 ÷ 4	0,2 ÷ 4	0,2 ÷ 4
	Max.flexible with ferrule - ferrule type [mm ²]	2,5 - WP25/19	2,5 - WP25/19	2,5 - WP25/19
Electrical characteristics According to European standard IEC EN 60947-7-2	Max AC/DC Voltage [V]	-	-	-
	Max current with rated cross-section [A]	-	-	-
	Section Caliber	A3	A3	A3
Electrical characteristics According to UL	Max AC/DC Voltage [V]	-	-	-
	Max current with rated cross-section [A]	-	-	-
	Section Min-Max [AWG]	24 - 12	24 - 12	24 - 12
Electrical characteristics According to ATEX directive and IEC ex standard	Max AC/DC Voltage [V]	-	-	-
	Max current with rated cross-section [A]	20	20	20
	Operating temperature [°C]	-40 +110	-40 +110	-40 +110
Rated impulse withstand voltage/pollution degree		6kV / 3	6kV / 3	6kV / 3
Insulation stripping length	[mm]	9	9	9
Width	[mm]	5.2	5.2	5.2
Length	[mm]	51.1	64.6	78.1
Height mounted on TH35/7,5	[mm]	39.2	39.2	39.2
Height mounted on TH35/15	[mm]	46.7	46.7	46.7
Insulation material temperature index (EN 60216-1)	[°C]	130	130	130
Plastic material		polyamide UL94V-0	polyamide UL94V-0	polyamide UL94V-0

APPROVALS



ACCESSORIES				
End section	Grey	EFC.2/PT/GR (cod. EFC201GR)	EFC.2/1+2/PT/GR (cod. EFC211GR)	EFC.2/2+2/PT/GR (cod. EFC221GR)
	Blue	EFC.2/PT/BL (cod. EFC201BL)	EFC.2/1+2/PT/BL (cod. EFC211BL)	EFC.2/2+2/PT/BL (cod. EFC221BL)
	Thickness [mm]	1,5	1,5	1,5
Cross connection	[1]	EFB.2/.../... (cod. EFB02...)	EFB.2/.../... (cod. EFB02...)	EFB.2/.../... (cod. EFB02...)
	Rated current / Rated current ATEX applications [A]	24 / 20	24 / 20	24 / 20
Coloured partition	red	DfE.1+1/R (cod. DfE01R)	DfE.1+2/R (cod. DfE02R)	DfE.2+2/R (cod. DfE03R)
105mm adhesive numbering strip		TMM102105AW (cod. TMM102105AW)	TMM102105AW (cod. TMM102105AW)	TMM102105AW (cod. TMM102105AW)
105mm snap numbering strip		TMM102105W (cod. TMM102105W)	TMM102105W (cod. TMM102105W)	TMM102105W (cod. TMM102105W)
Single marking tag		CNU/10/51 (cod. NU1051S)	CNU/10/51 (cod. NU1051S)	CNU/10/51 (cod. NU1051S)
Single marking tag for pitch insert		CNU/10/51 (cod. NU1051S)	CNU/10/51 (cod. NU1051S)	CNU/10/51 (cod. NU1051S)
End bracket	Screw TH35	BT/3 (cod. BT003)	BT/3 (cod. BT003)	BT/3 (cod. BT003)
	Snap-fit TH35	BTO (cod. BT007)	BTO (cod. BT007)	BTO (cod. BT007)

- Reduced wiring time
- Wire release button

	IMQ 18 ATEX 007U	IECEx IMQ 18.0002U
	I M2 Ex eb I Mb	Ex eb I Mb
	II 2G Ex eb IIC Gb	Ex eb IIC Gb

(1) See chapter accessories for more details



GREY VERSION	CODE TYPE	EFC400GR	EFC.4/GR	EFC410GR	EFC.4/1+2/GR	EFC420GR	EFC.4/2+2/GR
BLUE VERSION	CODE TYPE	EFC400BL	EFC.4/BL	EFC410BL	EFC.4/1+2/BL	EFC420BL	EFC.4/2+2/BL

TECHNICAL CHARACTERISTICS

Function/type		Feed-through	Feed-through	Feed-through
Rated cross-section	(mm ²)	4	4	4
Connecting capacity	Flexible (mm ²)	0,2 ÷ 6	0,2 ÷ 6	0,2 ÷ 6
	Rigid (mm ²)	0,2 ÷ 6	0,2 ÷ 6	0,2 ÷ 6
	Max.flexible with ferrule - ferrule type (mm ²)	4 - WP40/16	4 - WP40/16	4 - WP40/16
Electrical characteristics According to European standard IEC EN 60947-7-1	Max AC/DC Voltage (V)	800	800	800
	Max current with rated cross-section (A)	32	32	32
	Section Caliber	A4	A4	A4
Electrical characteristics According to UL	Max AC/DC Voltage (V)	600	600	600
	Max current with rated cross-section (A)	30	30	30
	Section Min-Max (AWG)	24 - 12	24 - 12	24 - 12
Electrical characteristics According to ATEX directive and IEC ex standard	Max AC/DC Voltage (V)	500	500	500
	Max current with rated cross-section (A)	26	26	26
	Operating temperature (°C)	-40 +110	-40 +110	-40 +110
Rated impulse withstand voltage/pollution degree		6kV / 3	6kV / 3	6kV / 3
Insulation stripping length	(mm)	10	10	10
Width	(mm)	6.2	6.2	6.2
Length	(mm)	55.2	71.8	88.4
Height mounted on TH35/7,5	(mm)	39.2	39.2	39.2
Height mounted on TH35/15	(mm)	46.7	46.7	46.7
Insulation material temperature index (EN 60216-1)	(°C)	130	130	130
Plastic material		polyamide UL94V-0	polyamide UL94V-0	polyamide UL94V-0

APPROVALS



ACCESSORIES

End section	Grey	EFC.4/PT/GR (cod. EFC401GR)	EFC.4/1+2/PT/GR (cod. EFC411GR)	EFC.4/2+2/PT/GR (cod. EFC421GR)
	Blue	EFC.4/PT/BL (cod. EFC401BL)	EFC.4/1+2/PT/BL (cod. EFC411BL)	EFC.4/2+2/PT/BL (cod. EFC421BL)
Cross connection	Thickness (mm)	1.5	1.5	1.5
	(1)	EFB.4/.../... (cod. EFB04...)	EFB.4/.../... (cod. EFB04...)	EFB.4/.../... (cod. EFB04...)
Coloured partition	Rated current / Rated current ATEX applications (A)	32 / 26	32 / 26	32 / 26
	red	DFE.1+1/R (cod. DFE01R)	DFE.1+2/R (cod. DFE02R)	DFE.2+2/R (cod. DFE03R)
105mm adhesive numbering strip		TMM102105AW (cod. TMM102105AW)	TMM102105AW (cod. TMM102105AW)	TMM102105AW (cod. TMM102105AW)
105mm snap numbering strip		TMM102105W (cod. TMM102105W)	TMM102105W (cod. TMM102105W)	TMM102105W (cod. TMM102105W)
Single marking tag		CNU/10/51 (cod. NU1051S)	CNU/10/51 (cod. NU1051S)	CNU/10/51 (cod. NU1051S)
Single marking tag for pitch insert		CNU/10/51 (cod. NU1051S)	CNU/10/51 (cod. NU1051S)	CNU/10/51 (cod. NU1051S)
End bracket	Screw TH35	BT/3 (cod. BT003)	BT/3 (cod. BT003)	BT/3 (cod. BT003)
	Snap-fit TH35	BTO (cod. BT007)	BTO (cod. BT007)	BTO (cod. BT007)

EFCE.4 SERIES

SPRING CLAMP EARTH TERMINAL BLOCKS WITH PUSH-IN TECHNOLOGY



- Reduced wiring time
- Wire release button

	IMQ 18 ATEX 007U	IECEx IMQ 18.0002U
	I M2 Ex eb I Mb	Ex eb I Mb
	II 2G Ex eb IIC Gb	Ex eb IIC Gb

(1) See chapter accessories for more details



YELLOW/GREEN VERSION		CODE TYPE	EFCE400	EFCE410	EFCE420
			EFCE.4	EFCE.4/1+2	EFCE.4/2+2
TECHNICAL CHARACTERISTICS					
Function/type			Earth terminal blocks	Earth terminal blocks	Earth terminal blocks
Rated cross-section		[mm ²]	4	4	4
Connecting capacity	Flexible	[mm ²]	0,2 ÷ 6	0,2 ÷ 6	0,2 ÷ 6
	Rigid	[mm ²]	0,2 ÷ 6	0,2 ÷ 6	0,2 ÷ 6
	Max.flexible with ferrule - ferrule type	[mm ²]	4 - WP40/16	4 - WP40/16	4 - WP40/16
Electrical characteristics According to European standard IEC EN 60947-7-1	Max AC/DC Voltage	[V]	-	-	-
	Max current with rated cross-section	[A]	-	-	-
	Section	Caliber	A4	A4	A4
Electrical characteristics According to UL	Max AC/DC Voltage	[V]	-	-	-
	Max current with rated cross-section	[A]	-	-	-
	Section Min-Max	[AWG]	24 - 10	24 - 10	24 - 10
Electrical characteristics According to ATEX directive and IEC ex standard	Max AC/DC Voltage	[V]	-	-	-
	Max current with rated cross-section	[A]	26	26	26
	Operating temperature	[°C]	-40 +110	-40 +110	-40 +110
Rated impulse withstand voltage/pollution degree			6kV / 3	6kV / 3	6kV / 3
Insulation stripping length		[mm]	10	10	10
Width		[mm]	6.2	6.2	6.2
Length		[mm]	55.2	71.8	88.4
Height mounted on TH35/7,5		[mm]	39.2	39.2	39.2
Height mounted on TH35/15		[mm]	46.7	46.7	46.7
Insulation material temperature index (EN 60216-1)		[°C]	130	130	130
Plastic material			polyamide UL94V-0	polyamide UL94V-0	polyamide UL94V-0
APPROVALS					
ACCESSORIES					
End section	Grey		EFC.4/PT/GR (cod. EFC401GR)	EFC.4/1+2/PT/GR (cod. EFC411GR)	EFC.4/2+2/PT/GR (cod. EFC421GR)
	Blue		EFC.4/PT/BL (cod. EFC401BL)	EFC.4/1+2/PT/BL (cod. EFC411BL)	EFC.4/2+2/PT/BL (cod. EFC421BL)
	Thickness	[mm]	1.5	1.5	1.5
Cross connection	[1]		EFB.4/.../... (cod. EFB04...)	EFB.4/.../... (cod. EFB04...)	EFB.4/.../... (cod. EFB04...)
	Rated current / Rated current ATEX applications	[A]	32 / 26	32 / 26	32 / 26
Coloured partition		red	DFF.1+1/R (cod. DFF01R)	DFF.1+2/R (cod. DFF02R)	DFF.2+2/R (cod. DFF03R)
105mm adhesive numbering strip			TMM102105AW (cod. TMM102105AW)	TMM102105AW (cod. TMM102105AW)	TMM102105AW (cod. TMM102105AW)
105mm snap numbering strip			TMM102105W (cod. TMM102105W)	TMM102105W (cod. TMM102105W)	TMM102105W (cod. TMM102105W)
Single marking tag			CNU/10/51 (cod. NU1051S)	CNU/10/51 (cod. NU1051S)	CNU/10/51 (cod. NU1051S)
Single marking tag for pitch insert			CNU/10/51 (cod. NU1051S)	CNU/10/51 (cod. NU1051S)	CNU/10/51 (cod. NU1051S)
End bracket	Screw TH35		BT/3 (cod. BT003)	BT/3 (cod. BT003)	BT/3 (cod. BT003)
	Snap-fit TH35		BTO (cod. BT007)	BTO (cod. BT007)	BTO (cod. BT007)

- Reduced wiring time
- Wire release button



IMQ 18 ATEX 007U
I M2 Ex eb I Mb
II 2G Ex eb IIC Gb

IECEx IMQ 18.0002U
Ex eb I Mb
Ex eb IIC Gb

(1) See chapter accessories for more details

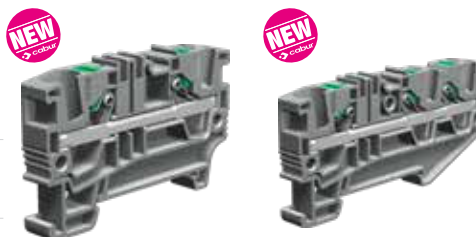

GREY VERSION	CODE TYPE	EFC600GR	EFC.6/GR	EFC610GR	EFC.6/1+2/GR
BLUE VERSION	CODE TYPE	EFC600BL	EFC.6/BL	EFC610BL	EFC.6/1+2/BL

TECHNICAL CHARACTERISTICS

Function/type		Feed-through	Feed-through
Rated cross-section	(mm ²)	6	6
Connecting capacity	Flexible (mm ²)	0.2 ÷ 10	0.2 ÷ 10
	Rigid (mm ²)	0.2 ÷ 10	0.2 ÷ 10
	Max.flexible with ferrule - ferrule type (mm ²)	6-WP60/20	6-WP60/20
Electrical characteristics According to European standard IEC EN 60947-7-1	Max AC/DC Voltage (V)	1000	1000
	Max current with rated cross-section (A)	41	41
	Section Caliber	A5	A5
Electrical characteristics According to UL	Max AC/DC Voltage (V)	600	600
	Max current with rated cross-section (A)	41	41
	Section Min-Max (AWG)	24 - 8	24 - 8
Electrical characteristics According to ATEX directive and IEC ex standard	Max AC/DC Voltage (V)	550	550
	Max current with rated cross-section (A)	35	35
	Operating temperature (°C)	-40 +110	-40 +110
Rated impulse withstand voltage/pollution degree		8kV / 3	8kV / 3
Insulation stripping length	(mm)	12	12
Width	(mm)	8.2	8.2
Length	(mm)	60.4	78.3
Height mounted on TH35/7,5	(mm)	39.2	39.2
Height mounted on TH35/15	(mm)	46.7	46.7
Insulation material temperature index (EN 60216-1)	(°C)	130	130
Plastic material		Polyamide UL94 V-0	Polyamide UL94 V-0

APPROVALS

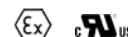

ACCESSORIES			
End section	Grey	EFC.6/PT/GR (cod. EFC601GR)	EFC.6/1+2/PT/GR (cod. EFC611GR)
	Blue	EFC.6/PT/BL (cod. EFC601BL)	EFC.6/1+2/PT/BL (cod. EFC611BL)
	Thickness (mm)	1,5	1,5
Cross connection	(1)	EFB.6/.../... (cod. EFB06...)	EFB.6/.../... (cod. EFB06...)
	Rated current / Rated current ATEX applications (A)	41	41
Coloured partition	red	DfE.1+1/R (cod. DfE01R)	DfE.1+2/R (cod. DfE02R)
105mm adhesive numbering strip		TMM102105AW (cod. TMM102105AW)	TMM102105AW (cod. TMM102105AW)
105mm snap numbering strip		TMM102105W (cod. TMM102105W)	TMM102105W (cod. TMM102105W)
Single marking tag		CNU/8/51 (NU0851S)	CNU/8/51 (NU0851S)
Single marking tag for pitch insert		CNU/10/51 (NU1051S)	CNU/10/51 (NU1051S)
End bracket	Screw TH35	BT/3 (cod. BT003)	BT/3 (cod. BT003)
	Snap-fit TH35	BT0 (cod. BT007)	BT0 (cod. BT007)

- Reduced wiring time
- Wire release button



	IMQ 18 ATEX 007U	IECEx IMQ 18.0002U
	I M2 Ex eb I Mb	Ex eb I Mb
	II 2G Ex eb IIC Gb	Ex eb IIC Gb

(1) See chapter accessories for more details

YELLOW/GREEN VERSION

**CODE
TYPE**

EFCE600

EFCE.6

EFCE610

EFCE.6/1+2

TECHNICAL CHARACTERISTICS

Function/type		Earth terminal block	Earth terminal block
Rated cross-section	[mm ²]	6	6
Connecting capacity	Flexible	0.2 ÷ 10	0.2 ÷ 10
	Rigid	0.2 ÷ 10	0.2 ÷ 10
	Max.flexible with ferrule - ferrule type	6-WP60/20	6-WP60/20
Electrical characteristics According to European standard IEC EN 60947-7-1	Max AC/DC Voltage	-	-
	Max current with rated cross-section	-	-
	Section	Caliber A5	A5
Electrical characteristics According to UL	Max AC/DC Voltage	-	-
	Max current with rated cross-section	-	-
	Section Min-Max	24 - 8	24 - 8
Electrical characteristics According to ATEX directive and IEC ex standard	Max AC/DC Voltage	-	-
	Max current with rated cross-section	-	-
	Operating temperature	-40 +110	-40 +110
Rated impulse withstand voltage/pollution degree		8kV / 3	8kV / 3
Insulation stripping length	[mm]	12	12
Width	[mm]	8.2	8.2
Length	[mm]	60.4	78.3
Height mounted on TH35/7,5	[mm]	39.2	39.2
Height mounted on TH35/15	[mm]	46.7	46.7
Insulation material temperature index (EN 60216-1)	[°C]	130	130
Plastic material		Poliammide UL94 V-0	Poliammide UL94 V-0

APPROVALS

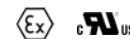

ACCESSORIES

End section	Grey	EFC.6/PT/GR (cod. EFC601GR)	EFC.6/1+2/PT/GR (cod. EFC611GR)
	Blue	EFC.6/PT/BL (cod. EFC601BL)	EFC.6/1+2/PT/BL (cod. EFC611BL)
	Thickness	[mm]	1,5
Cross connection	[1]	EFB.6/.../... (cod. EFB06...)	EFB.6/.../... (cod. EFB06...)
	Rated current / Rated current ATEX applications	[A]	41
Coloured partition	red	DFE.1+1/R (cod. DFE01R)	DFE.1+2/R (cod. DFE02R)
105mm adhesive numbering strip		TMM102105AW (cod. TMM102105AW)	TMM102105AW (cod. TMM102105AW)
105mm snap numbering strip		TMM102105W (cod. TMM102105W)	TMM102105W (cod. TMM102105W)
Single marking tag		CNU/8/51 (NU0851S)	CNU/8/51 (NU0851S)
Single marking tag for pitch insert		CNU/10/51 (NU1051S)	CNU/10/51 (NU1051S)
End bracket	Screw TH35	BT/3 (cod. BT003)	BT/3 (cod. BT003)
	Snap-fit TH35	BTO (cod. BT007)	BTO (cod. BT007)

EFD.1 SERIES

SPRING CLAMP TERMINAL BLOCKS WITH 2 LEVELS AND PUSH-IN TECHNOLOGY



- Reduced wiring time
- Wire release button



IMQ 18 ATEX 007U
I M2 Ex eb I Mb
II 2G Ex eb IIC Gb

IECEx IMQ 18.0002U
Ex eb I Mb
Ex eb IIC Gb

(1) See chapter accessories for more details



GREY VERSION	CODE TYPE	EFD100GR	EFD110GR	EFD120GR
		EFD.1/GR	EFD.1/CI/GR	EFD.1/E/GR
BLUE VERSION	CODE TYPE	EFD100BL	EFD110BL	
		EFD.1/BL	EFD.1/CI/BL	

TECHNICAL CHARACTERISTICS

Function/type		2 levels	2 levels	2 levels
Rated cross-section	(mm ²)	1,5	1,5	1,5
Connecting capacity	Flexible (mm ²)	0.2 ÷ 1.5	0.2 ÷ 1.5	0.2 ÷ 1.5
	Rigid (mm ²)	0.2 ÷ 1.5	0.2 ÷ 1.5	0.2 ÷ 1.5
	Max.flexible with ferrule - ferrule type (mm ²)	1.5 - WP15/14	1.5 - WP15/14	1.5 - WP15/14
Electrical characteristics According to European standard IEC EN 60947-7-1	Max AC/DC Voltage (V)	630	630	630
	Max current with rated cross-section (A)	17,5	17,5	17,5
	Section Caliber	A1 - B1	A1 - B1	A1 - B1
Electrical characteristics According to UL	Max AC/DC Voltage (V)	300	300	300
	Max current with rated cross-section (A)	15	15	15
	Section Min-Max (AWG)	26 - 14	26 - 14	26 - 14
Electrical characteristics According to ATEX directive and IEC ex standard	Max AC/DC Voltage (V)	440	440	440
	Max current with rated cross-section (A)	16	16	16
	Operating temperature (°C)	-40 +110	-40 +110	-40 +110
Rated impulse withstand voltage/pollution degree		6 kV / 3	6 kV / 3	6 kV / 3
Insulation stripping length (mm)		8	8	8
Width (mm)		3,5	3,5	3,5
Length (mm)		81	81	81
Height mounted on TH35/7,5 (mm)		50	50	50
Height mounted on TH35/15 (mm)		57,5	57,5	57,5
Insulation material temperature index (EN 60216-1) (°C)		130	130	130
Plastic material		Polyamide UL94 V-0	Polyamide UL94 V-0	Polyamide UL94 V-0

APPROVALS

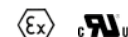
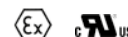

ACCESSORIES

End section	Grey	EFD.1/PT/GR (cod. EFD101GR)	EFD.1/PT/GR (cod. EFD101GR)	EFD.1/PT/GR (cod. EFD101GR)
	Blue	EFD.1/PT/BL (cod. EFD101BL)	EFD.1/PT/BL (cod. EFD101BL)	EFD.1/PT/BL (cod. EFD101BL)
Cross connection	Thickness (mm)	1,5	1,5	1,5
	[1] Rated current / Rated current ATEX applications (A)	EFB.1/.../... (cod. EFB01...)	EFB.1/.../... (cod. EFB01...)	EFB.1/.../... (cod. EFB01...)
Coloured partition	red	DFE.2P/R (cod. DFE04R)	DFE.2P/R (cod. DFE04R)	DFE.2P/R (cod. DFE04R)
105mm adhesive numbering strip		TMM102105AW (cod. TMM102105AW)	TMM102105AW (cod. TMM102105AW)	TMM102105AW (cod. TMM102105AW)
105mm snap numbering strip		TMM102105W (cod. TMM102105W)	TMM102105W (cod. TMM102105W)	TMM102105W (cod. TMM102105W)
Single marking tag		CNU/8/35 (cod. NU0835S)	CNU/8/35 (cod. NU0835S)	CNU/8/35 (cod. NU0835S)
Single marking tag for pitch insert		CNU/10/35 (cod. NU1035S)	CNU/10/35 (cod. NU1035S)	CNU/10/35 (cod. NU1035S)
End bracket	Screw TH35	BT/3 (cod. BT003)	BT/3 (cod. BT003)	BT/3 (cod. BT003)
	Snap-fit TH35	BT0 (cod. BT007)	BT0 (cod. BT007)	BT0 (cod. BT007)

EFD.2 SERIES

SPRING CLAMP TERMINAL BLOCKS WITH 2 LEVELS AND PUSH-IN TECHNOLOGY



- Reduced wiring time
- Wire release button

	IMQ 18 ATEX 007U	IECEx IMQ 18.0002U
	I M2 Ex eb I Mb	Ex eb I Mb
	II 2G Ex eb IIC Gb	Ex eb IIC Gb

(1) See chapter accessories for more details



GREY VERSION	CODE TYPE	EFD200GR	EFD.2/GR	EFD210GR	EFD.2/CI/GR	EFD220GR	EFD.2/E/GR
BLUE VERSION	CODE TYPE	EFD200BL	EFD.2/BL	EFD210BL	EFD.2/CI/BL		

TECHNICAL CHARACTERISTICS

Function/type		2 levels	2 levels and internal connection	2 feed-through levels + earth
Rated cross-section	(mm ²)	2.5	2.5	2.5
Connecting capacity	Flexible (mm ²)	0,2 ÷ 4	0,2 ÷ 4	0,2 ÷ 4
	Rigid (mm ²)	0,2 ÷ 4	0,2 ÷ 4	0,2 ÷ 4
	Max.flexible with ferrule - ferrule type (mm ²)	2,5 - WP25/19	2,5 - WP25/19	2,5 - WP25/19
Electrical characteristics According to European standard IEC EN 60947-7-1	Max AC/DC Voltage (V)	800	800	800
	Max current with rated cross-section (A)	22	22	22
	Section Caliber	A3	A3	A3
Electrical characteristics According to UL	Max AC/DC Voltage (V)	600	600	600
	Max current with rated cross-section (A)	20	20	20
	Section Min-Max (AWG)	24-12	24-12	24-12
Electrical characteristics According to ATEX directive and IEC ex standard	Max AC/DC Voltage (V)	500	500	500
	Max current with rated cross-section (A)	18	18	18
	Operating temperature (°C)	-40 +110	-40 +110	-40 +110
Rated impulse withstand voltage/pollution degree		6kV / 3	6kV / 3	6kV / 3
Insulation stripping length (mm)		9	9	9
Width (mm)		5.2	5.2	5.2
Length (mm)		71.6	71.6	71.6
Height mounted on TH35/7,5 (mm)		53.8	53.8	53.8
Height mounted on TH35/15 (mm)		61.3	61.3	61.3
Insulation material temperature index (EN 60216-1) (°C)		130	130	130
Plastic material		polyamide UL94V-0	polyamide UL94V-0	polyamide UL94V-0

APPROVALS



ACCESSORIES		EFD.2/PT/GR (cod. EFD201GR)	EFD.2/PT/GR (cod. EFD201GR)	EFD.2/PT/GR (cod. EFD201GR)
End section	Grey	EFD.2/PT/GR (cod. EFD201GR)	EFD.2/PT/GR (cod. EFD201GR)	EFD.2/PT/GR (cod. EFD201GR)
	Blue	EFD.2/PT/BL (cod. EFD201BL)	EFD.2/PT/BL (cod. EFD201BL)	EFD.2/PT/BL (cod. EFD201BL)
Cross connection	Thickness (mm)	1.5	1.5	1.5
	[1]	EFB.2/.../... (cod. EFB02...)	EFB.2/.../... (cod. EFB02...)	EFB.2/.../... (cod. EFB02...)
Coloured partition	Rated current / Rated current ATEX applications (A)	22 / 18	22 / 18	22 / 18
	red	DFE.2P/R (cod. DFE04R)	DFE.2P/R (cod. DFE04R)	DFE.2P/R (cod. DFE04R)
105mm adhesive numbering strip		-	-	-
105mm snap numbering strip		-	-	-
Single marking tag		CNU/10/51 (cod. NU1051S)	CNU/10/51 (cod. NU1051S)	CNU/10/51 (cod. NU1051S)
Single marking tag for pitch insert		CNU/10/51 (cod. NU1051S)	CNU/10/51 (cod. NU1051S)	CNU/10/51 (cod. NU1051S)
End bracket	Screw TH35	BT/3 (cod. BT003)	BT/3 (cod. BT003)	BT/3 (cod. BT003)
	Snap-fit TH35	BTO (cod. BT007)	BTO (cod. BT007)	BTO (cod. BT007)

- Reduced wiring time
- Wire release button

	IMQ 18 ATEX 007U	IECEx IMQ 18.0002U
	I M2 Ex eb I Mb	Ex eb I Mb
	II 2G Ex eb IIC Gb	Ex eb IIC Gb

(1) See chapter accessories for more details



GREY VERSION	CODE TYPE	EFD400GR	EFD410GR	EFD420GR
		EFD.4/GR	EFD.4/CI/GR	EFD.4/E/GR
BLUE VERSION	CODE TYPE	EFD400BL	EFD410BL	
		EFD.4/BL	EFD.4/CI/BL	

TECHNICAL CHARACTERISTICS

Function/type		2 levels	2 levels and internal connection	2 levels (Feed-through + terra)
Rated cross-section	(mm ²)	4	4	4
Connecting capacity	Flexible (mm ²)	0,2 ÷ 6	0,2 ÷ 6	0,2 ÷ 6
	Rigid (mm ²)	0,2 ÷ 6	0,2 ÷ 6	0,2 ÷ 6
	Max.flexible with ferrule - ferrule type (mm ²)	4 - WP40/16	4 - WP40/16	4 - WP40/16
Electrical characteristics According to European standard IEC EN 60947-7-1	Max AC/DC Voltage (V)	800	800	800
	Max current with rated cross-section (A)	29	29	29
	Section Caliber	A4	A4	A4
Electrical characteristics According to UL	Max AC/DC Voltage (V)	600	600	600
	Max current with rated cross-section (A)	30	30	30
	Section Min-Max (AWG)	24-10	24-10	24-10
Electrical characteristics According to ATEX directive and IEC ex standard	Max AC/DC Voltage (V)	500	500	500
	Max current with rated cross-section (A)	25	25	25
	Operating temperature (°C)	-40 +110	-40 +110	-40 +110
Rated impulse withstand voltage/pollution degree		6kV / 3	6kV / 3	6kV / 3
Insulation stripping length	(mm)	10	10	10
Width	(mm)	6.2	6.2	6.2
Length	(mm)	81.7	81.7	81.7
Height mounted on TH35/7,5	(mm)	57.7	57.7	57.7
Height mounted on TH35/15	(mm)	65.2	65.2	65.2
Insulation material temperature index (EN 60216-1)	(°C)	130	130	130
Plastic material		polyamide UL94V-0	polyamide UL94V-0	polyamide UL94V-0

APPROVALS



ACCESSORIES

End section	Grey	EFD.4/PT/GR (cod. EFD401GR)	EFD.4/PT/GR (cod. EFD401GR)	EFD.4/PT/GR (cod. EFD401GR)
	Blue	EFD.4/PT/BL (cod. EFD401BL)	EFD.4/PT/BL (cod. EFD401BL)	EFD.4/PT/BL (cod. EFD401BL)
Cross connection	Thickness (mm)	1.5	1.5	1.5
	[1]	EFB.4/.../... (cod. EFB04...)	EFB.4/.../... (cod. EFB04...)	EFB.4/.../... (cod. EFB04...)
Coloured partition	Rated current / Rated current ATEX applications (A)	29 / 25	29 / 25	29 / 25
	red	DFE.2P/R (cod. DFE04R)	DFE.2P/R (cod. DFE04R)	DFE.2P/R (cod. DFE04R)
105mm adhesive numbering strip		-	-	-
105mm snap numbering strip		-	-	-
Single marking tag		CNU/10/51 (cod. NU1051S)	CNU/10/51 (cod. NU1051S)	CNU/10/51 (cod. NU1051S)
Single marking tag for pitch insert		CNU/10/51 (cod. NU1051S)	CNU/10/51 (cod. NU1051S)	CNU/10/51 (cod. NU1051S)
End bracket	Screw TH35	BT/3 (cod. BT003)	BT/3 (cod. BT003)	BT/3 (cod. BT003)
	Snap-fit TH35	BTO (cod. BT007)	BTO (cod. BT007)	BTO (cod. BT007)

- Reduced wiring time
- Wire release button

NEW
cabur



	IMQ 18 ATEX 007U	IECEx IMQ 18.0002U
	I M2 Ex eb I Mb	Ex eb I Mb
	II 2G Ex eb IIC Gb	Ex eb IIC Gb

(1) See chapter accessories for more details

YELLOW/GREEN VERSION	CODE TYPE	EFDE100	EFDE200	EFDE400
----------------------	-----------	---------	---------	---------

TECHNICAL CHARACTERISTICS

Function/type		2 levels earth terminal blocks	2 levels earth terminal blocks	2 levels earth terminal blocks
Rated cross-section	[mm ²]	1,5	2,5	4
Connecting capacity	Flexible	0,2 ÷ 1,5	0,2 ÷ 4	0,2 ÷ 6
	Rigid	0,2 ÷ 1,5	0,2 ÷ 4	0,2 ÷ 6
	Max.flexible with ferrule - ferrule type	1,5 - WP15/14	2,5 - WP25/19	4 - WP40/16
Electrical characteristics According to European standard IEC EN 60947-7-2	Max AC/DC Voltage	-	-	-
	Max current with rated cross-section	-	-	-
Electrical characteristics According to UL	Section	Caliber A1 - B1	A3	A4
	Max AC/DC Voltage	-	-	-
	Section Min-Max	26 - 14	24-12	24-10
Electrical characteristics According to ATEX directive and IEC ex standard	Max AC/DC Voltage	-	-	-
	Max current with rated cross-section	-	18	25
	Operating temperature	-40 +110	-40+110	-40+110
Rated impulse withstand voltage/pollution degree		6 kV / 3	6kV / 3	6kV / 3
Insulation stripping length	[mm]	8	9	10
Width	[mm]	3,5	5,2	6,2
Length	[mm]	81	71,6	81,7
Height mounted on TH35/7,5	[mm]	50	53,8	57,7
Height mounted on TH35/15	[mm]	57,5	61,3	65,2
Insulation material temperature index (EN 60216-1)	[°C]	130	130	130
Plastic material		Polyamide UL94 V-0	polyamide UL94V-0	polyamide UL94V-0

APPROVALS



ACCESSORIES

End section	Grey	EFD.1/PT/GR (cod. EFD101GR)	EFD.2/PT/GR (cod. EFD201GR)	EFD.4/PT/GR (cod. EFD401GR)
	Blue	EFD.1/PT/BL (cod. EFD101BL)	EFD.2/PT/BL (cod. EFD201BL)	EFD.4/PT/BL (cod. EFD401BL)
	Thickness [mm]	1,5	1,5	1,5
Cross connection	(1)	EFB.1/.../... (cod. EFB01...)	EFB.2/.../... (cod. EFB02...)	EFB.4/.../... (cod. EFB04...)
	Rated current / Rated current ATEX applications [A]	17,5	22 / 18	29 / 25
Coloured partition	red	DFE.2P/R (cod. DFE04R)	DFE.2P/R (cod. DFE04R)	DFE.2P/R (cod. DFE04R)
105mm adhesive numbering strip		TMM102105AW (cod. TMM102105AW)	-	-
105mm snap numbering strip		TMM102105W (cod. TMM102105W)	-	-
Single marking tag		CNU/8/35 (cod. NU0835S)	CNU/10/51 (cod. NU1051S)	CNU/10/51 (cod. NU1051S)
Single marking tag for pitch insert		CNU/10/35 (cod. NU1035S)	CNU/10/51 (cod. NU1051S)	CNU/10/51 (cod. NU1051S)
End bracket	Screw TH35	BT/3 (cod. BT003)	BT/3 (cod. BT003)	BT/3 (cod. BT003)
	Snap-fit TH35	BTO (cod. BT007)	BTO (cod. BT007)	BTO (cod. BT007)

- Reduced wiring time
- Wire release button



(1) See chapter accessories for more details

GREY VERSION	CODE TYPE	EFS200GR	EFS.2/GR	EFS400GR	EFS.4/GR
BLUE VERSION	CODE TYPE	EFS200BL	EFS.2/BL	EFS400BL	EFS.4/BL

TECHNICAL CHARACTERISTICS

Function/type		disconnectable with blade	disconnectable with blade
Rated cross-section	(mm ²)	2.5	4
Connecting capacity	Flexible (mm ²)	0,2 ÷ 4	0,2 ÷ 6
	Rigid (mm ²)	0,2 ÷ 4	0,2 ÷ 6
	Max.flexible with ferrule - ferrule type (mm ²)	2,5 - WP25/19	4 - WP40/16
Electrical characteristics According to European standard IEC EN 60947-7-1	Max AC/DC Voltage (V)	630	630
	Max current with rated cross-section (A)	13	26
	Section Caliber	A3	A4
Electrical characteristics According to UL	Max AC/DC Voltage (V)	300	600
	Max current with rated cross-section (A)	12	18.5
	Section Min-Max (AWG)	24-12	24-10
Electrical characteristics According to ATEX directive and IEC ex standard	Max AC/DC Voltage (V)	-	-
	Max current with rated cross-section (A)	-	-
Operating temperature (°C)		-	-
Rated impulse withstand voltage/pollution degree		4kV / 3	4kV / 3
Insulation stripping length (mm)		9	10
Width (mm)		5.2	6.2
Length (mm)		49.6	55.2
Height mounted on TH35/7,5 (mm)		41.2	41.2
Height mounted on TH35/15 (mm)		48.7	48.7
Insulation material temperature index (EN 60216-1) (°C)		130	130
Plastic material		polyamide UL94V-0	polyamide UL94V-0

APPROVALS



ACCESSORIES			
End section	Grey	EFC.2/PT/GR (cod. EFC201GR)	EFC.4/PT/GR (cod. EFC401GR)
	Blue	EFC.2/PT/BL (cod. EFC201BL)	EFC.4/PT/BL (cod. EFC401BL)
	Thickness (mm)	1.5	1.5
Cross connection	(1)	EFB.2/.../... (cod. EFB02...)	EFB.4/.../... (cod. EFB04...)
	Rated current / Rated current ATEX applications (A)	24	32
Coloured partition	red	DfE.1+1/R (cod. DfE01R)	DfE.1+1/R (cod. DfE01R)
105mm adhesive numbering strip		-	-
105mm snap numbering strip		-	-
Single marking tag		CNU/10/51 (cod. NU1051S)	CNU/10/51 (cod. NU1051S)
Single marking tag for pitch insert		CNU/10/51 (cod. NU1051S)	CNU/10/51 (cod. NU1051S)
End bracket	Screw TH35	BT/3 (cod. BT003)	BT/3 (cod. BT003)
	Snap-fit TH35	BTO (cod. BT007)	BTO (cod. BT007)

EFT.2 SERIES

SPRING CLAMP TERMINAL BLOCKS WITH 3 LEVELS AND PUSH-IN TECHNOLOGY



- Reduced wiring time
- Wire release button

	IMQ 18 ATEX 007U	IECEx IMQ 18.0002U
	I M2 Ex eb I Mb	Ex eb I Mb
	II 2G Ex eb IIC Gb	Ex eb IIC Gb

(1) See chapter accessories for more details



GREY VERSION	CODE TYPE	EFT200GR*	EFT.2/GR	EFT250GR	EFT.2/S/GR
BLUE VERSION	CODE TYPE	EFT200BL	EFT.2/BL		
YELLOW/GREEN VERSION	CODE TYPE			EFTE200	EFTE.2

TECHNICAL CHARACTERISTICS

Function/type		3 levels	3 levels + earth	3 levels - for sensors	
Rated cross-section	(mm ²)	2.5	2.5	2.5	
Connecting capacity	Flexible	0,2 ÷ 4	0,2 ÷ 4	0,2 ÷ 4	
	Rigid	0,2 ÷ 4	0,2 ÷ 4	0,2 ÷ 4	
	Max.flexible with ferrule - ferrule type	(mm ²)	2,5 - WP25/19	2,5 - WP25/19	2,5 - WP25/19
Electrical characteristics According to European standard IEC EN 60947-7-1	Max AC/DC Voltage	(V)	800	250	
	Max current with rated cross-section	(A)	24	-	23
	Section	Caliber	A3	A3	A3
Electrical characteristics According to UL	Max AC/DC Voltage	(V)	600	300	
	Max current with rated cross-section	(A)	20	-	20
	Section Min-Max	(AWG)	24-12	24-12	24-12
Electrical characteristics According to ATEX directive and IEC ex standard	Max AC/DC Voltage	(V)	320	200	
	Max current with rated cross-section	(A)	20	20	21
Operating temperature	(°C)	-40+110	-40+110	-40+110	
Rated impulse withstand voltage/pollution degree		6kV / 3	6kV / 3	6kV / 3	
Insulation stripping length	(mm)	9	9	9	
Width	(mm)	5.2	5.2	5.2	
Length	(mm)	106.2	106.2	89	
Height mounted on TH35/7,5	(mm)	68.4	68.4	43.9	
Height mounted on TH35/15	(mm)	75.9	75.9	51.4	
Insulation material temperature index (EN 60216-1)	(°C)	130	130	130	
Plastic material		polyamide UL94V-0	polyamide UL94V-0	polyamide UL94V-0	

APPROVALS



ACCESSORIES				
End section	Grey	EFT.2/PT/GR (cod. EFT201GR)	EFT.2/PT/GR (cod. EFT201GR)	EFT.2/S/PT/GR (cod. EFT251GR)
	Blue	EFT.2/PT/BL (cod. EFT201BL)	-	-
	Thickness	(mm)	1.5	1.5
Cross connection	(1)	EFB.2/.../... (cod. EFB02...)	EFB.2/.../... (cod. EFB02...)	EFB.2/.../... (cod. EFB02...)
	Rated current / Rated current ATEX applications	(A)	24 / 18	24 / 18
Coloured partition	red	-	-	-
105mm adhesive numbering strip		-	-	-
105mm snap numbering strip		-	-	-
Single marking tag		CNU/10/51 (cod. NU1051S)	CNU/10/51 (cod. NU1051S)	CNU/10/51 (cod. NU1051S)
Single marking tag for pitch insert		CNU/10/51 (cod. NU1051S)	CNU/10/51 (cod. NU1051S)	CNU/10/51 (cod. NU1051S)
End bracket	Screw TH35	BT/3 (cod. BT003)	BT/3 (cod. BT003)	BT/3 (cod. BT003)
	Snap-fit TH35	BTO (cod. BT007)	BTO (cod. BT007)	BTO (cod. BT007)



*Also available 3 levels terminal block with internal connection code EFT210GR type EFT.2/CI/GR (grey); code EFT210BL type EFT.2/CI/BL (blue)

For more information, visit our website www.cabur.it

- Reduced wiring time
- Wire release button



(1) See chapter accessories for more details

GREY VERSION	CODE TYPE	EFDS200GR EFDS.2/GR	EFDS210GR EFDS.2/1S/GR	EFDS220GR EFDS.2/P/GR
TECHNICAL CHARACTERISTICS				
Function/type		2 levels disconnect	2 levels disconnect (disconnectable upper level + feed-through on lower)	2 levels Feed-through
Rated cross-section	(mm ²)	2.5	2.5	2.5
Connecting capacity	Flexible	0,2 ÷ 4	0,2 ÷ 4	0,2 ÷ 4
	Rigid	0,2 ÷ 4	0,2 ÷ 4	0,2 ÷ 4
	Max.flexible with ferrule - ferrule type	(mm ²)	2,5 - WP25/19	2,5 - WP25/19
Electrical characteristics According to European standard IEC EN 60947-7-1	Max AC/DC Voltage	(V)	630	630
	Max current with rated cross-section	(A)	17	17
	Section	Caliber	A3	A3
Electrical characteristics According to UL	Max AC/DC Voltage	(V)	300	300
	Max current with rated cross-section	(A)	12	12
	Section Min-Max	(AWG)	24-12	24-12
Electrical characteristics According to ATEX directive and IEC ex standard	Max AC/DC Voltage	(V)	-	-
	Max current with rated cross-section	(A)	-	-
Operating temperature	(°C)	-	-	-
Rated impulse withstand voltage/pollution degree		6kV / 3	6kV / 3	6kV / 3
Insulation stripping length	(mm)	9	9	9
Width	(mm)	5.2	5.2	5.2
Length	(mm)	110	110	110
Height mounted on TH35/7,5	(mm)	54	54	54.5
Height mounted on TH35/15	(mm)	61.5	61.5	62
Insulation material temperature index (EN 60216-1)	(°C)	130	130	130
Plastic material		polyamide UL94V-0	polyamide UL94V-0	polyamide UL94V-0
APPROVALS				
ACCESSORIES				
End section	Grey	EFDS.2/PT/GR (cod. EFDS201GR)	EFDS.2/PT/GR (cod. EFDS201GR)	EFDS.2/PT/GR (cod. EFDS201GR)
	Blue	-	-	-
	Thickness	(mm)	1.5	1.5
Cross connection	(1)	EFB.2/.../... (cod. EFB02...)	EFB.2/.../... (cod. EFB02...)	EFB.2/.../... (cod. EFB02...)
	Rated current / Rated current ATEX applications	(A)	17/-	17/-
Coloured partition	red	-	-	-
105mm adhesive numbering strip		-	-	-
105mm snap numbering strip		-	-	-
Single marking tag		CNU/10/51 (cod. NU1051S)	CNU/10/51 (cod. NU1051S)	CNU/10/51 (cod. NU1051S)
Single marking tag for pitch insert		CNU/10/51 (cod. NU1051S)	CNU/10/51 (cod. NU1051S)	CNU/10/51 (cod. NU1051S)
End bracket	Screw TH35	BT/3 (cod. BT003)	BT/3 (cod. BT003)	BT/3 (cod. BT003)
	Snap-fit TH35	BTO (cod. BT007)	BTO (cod. BT007)	BTO (cod. BT007)

EFF.4

FUSE-HOLDER TERMINAL BLOCKS WITH PUSH-IN TECHNOLOGY



- Reduced wiring time
- Wire release button



(1) See chapter accessories for more details

GREY VERSION	CODE TYPE	EFF400GR	EFF.4/GR	EFF448GR	EFF.4/C48/GR	EFF423GR	EFF.4/C230/GR
BLUE VERSION	CODE TYPE	EFF400BL	EFF.4/BL				

TECHNICAL CHARACTERISTICS

Function/type		Fuse-holders 5x20	Fuse-holders 5x20 with led	Fuse-holders 5x20 with led
Rated cross-section	(mm ²)	4	4	4
Connecting capacity	Flexible (mm ²)	0,2 ÷ 6	0,2 ÷ 6	0,2 ÷ 6
	Rigid (mm ²)	0,2 ÷ 6	0,2 ÷ 6	0,2 ÷ 6
	Max.flexible with ferrule - ferrule type (mm ²)	4 - WP40/16	4 - WP40/16	4 - WP40/16
Electrical characteristics According to European standard IEC EN 60947-7-1	Max AC/DC Voltage (V)	630	48	230
	Max current with rated cross-section (A)	6.3	6.3	6.3
	Section Caliber	A4	A4	A4
Electrical characteristics According to UL	Max AC/DC Voltage (V)	600	48	230
	Max current with rated cross-section (A)	6.3	6.3	6.3
	Section Min-Max (AWG)	24-10	24-10	24-10
Rated impulse withstand voltage/pollution degree		4kV / 3	4kV / 3	4kV / 3
Insulation stripping length	(mm)	10	10	10
Width	(mm)	6.2	6.2	6.2
Length	(mm)	55.2	55.2	55.2
Height mounted on TH35/7,5	(mm)	67.1	67.1	67.1
Height mounted on TH35/15	(mm)	74.6	74.6	74.6
Insulation material temperature index (EN 60216-1)	(°C)	130	130	130
Plastic material		polyamide UL94V-0	polyamide UL94V-0	polyamide UL94V-0

APPROVALS



ACCESSORIES				
End section	Grey		EFC.4/PT/GR (cod. EFC401GR)	EFC.4/PT/GR (cod. EFC401GR)
	Blue		EFC.4/PT/BL (cod. EFC401BL)	EFC.4/PT/BL (cod. EFC401BL)
	Thickness (mm)	1.5		
Cross connection			EFB.4/.../... (cod. EFB04...)	EFB.4/.../... (cod. EFB04...)
	Rated current (A)	32A		
Coloured partition	red		DFE.1+1/R (cod. DFE01R)	DFE.1+1/R (cod. DFE01R)
Miniature fuse			F5/... (cod. FN...)	F5/... (cod. FN...)
Led circuit (contains 2 contact slats, 1 led microcircuits)	For voltage 12V 24V 48V AC/DC		CIL/12-24-48 (cod. CB518)	already installed
	For voltage 115V 230V AC/DC		CIL/115-230 (cod. CB523)	-
Single marking tag			CNU/10/51 (cod. NU1051S)	CNU/10/51 (cod. NU1051S)
Single marking tag for pitch insert			CNU/10/61 (cod. NU1061S)	CNU/10/61 (cod. NU1061S)
End bracket	Screw TH35		BT/3 (cod. BT003)	BT/3 (cod. BT003)
	Snap-fit TH35		BTO (cod. BT007)	BTO (cod. BT007)

FUSE-HOLDER TERMINAL BLOCKS WITH PUSH-IN TECHNOLOGY



- Suitable for \varnothing 5 x 20 mm fuses
- Possibility to signal the interruption of the fuse using a non-polarized LED microcircuit (CIL/...)
- Possible insertion of a 1 A diode instead of the fuse.
- Marking tag: CNU/8/51 cod. NU0851S

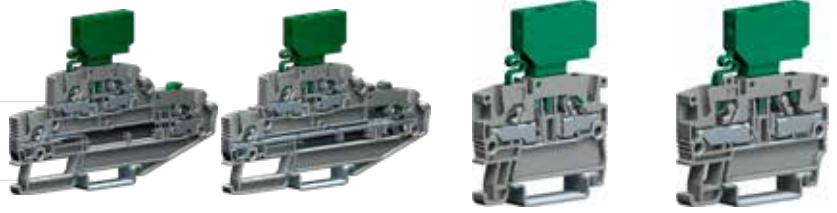

EFC SPRING CLAMPS

GREY VERSION		CODE TYPE	EFDS202GR CPFE.2 + EFDS.2/GR	EFDS212GR CPFE.2 + EFDS.2/1S/GR	EFS202GR CPFE.2 + EFS.2/GR	EFS402GR CPFE.4 + EFS.4/GR
TECHNICAL CHARACTERISTICS						
Function/type						
Rated cross-section		(mm ²)	2,5	2,5	2,5	4
Connecting capacity	Flexible	(mm ²)	0,2 ÷ 4	0,2 ÷ 4	0,2 ÷ 4	0,2 ÷ 6
	Rigid	(mm ²)	0,2 ÷ 4	0,2 ÷ 4	0,2 ÷ 4	0,2 ÷ 6
	Max.flexible with ferrule - ferrule type		2,5 - WP25/19	2,5 - WP25/19	2,5 - WP25/19	4 - WP40/16
Values referred to the level connected to the cartridge						
Electrical characteristics According to European standard IEC EN 60947-7-1	Max AC/DC Voltage	[V]	250V	250V	250V	250V
	Max current with rated cross-section	[A]	6,3 con fusibile	6,3 con fusibile	6,3 con fusibile	6,3 con fusibile
	Section	Calibro	A3	A3	A3	A4
Electrical characteristics According to UL	Max AC/DC Voltage	[V]	300	300	300	300
	Max current with rated cross-section	[A]	6,3 con fusibile	6,3 con fusibile	6,3 con fusibile	6,3 con fusibile
	Section Min-Max	[AWG]	24-12	24-12	24-12	24-10
Rated impulse withstand voltage/pollution degree			4kV/3	4kV/3	4kV/3	4kV/3
Values referred to the lower level of EFDS202(212)GR						
Electrical characteristics According to European standard IEC EN 60947-7-1	Max AC/DC Voltage	[V]	630	630	-	-
	Max current with rated cross-section	[A]	17	17	-	-
	Section	Calibro	A3	A3	-	-
Electrical characteristics According to UL	Max AC/DC Voltage	[V]	300	300	-	-
	Max current with rated cross-section	[A]	12	12	-	-
	Section Min-Max	[AWG]	24-12	24-12	-	-
Rated impulse withstand voltage/pollution degree			6kV/3	6kV/3	-	-
Insulation stripping length		(mm)	9	9	9	10
Width		(mm)	5,2	5,2	5,2	6,2
Length		(mm)	110	110	49,6	55,2
Height mounted on TH35/7,5		(mm)	75	75	60,2	60,2
Height mounted on TH35/15		(mm)	82,5	82,5	67,7	67,7

APPROVALS



ACCESSORIES

End section	Grey		EFDS.2/PT/GR (cod. EFDS201GR)	EFDS.2/PT/GR (cod. EFDS201GR)	EFC.2/PT/GR (cod. EFC201GR)	EFC.4/PT/GR (cod. EFC401GR)
	Blue		-	-	-	-
	Thickness	(mm)	1,5	1,5	1,5	1,5
Cross connection			EFB.2/.../... (cod. EFB02...)	EFB.2/.../... (cod. EFB02...)	EFB.2/.../... (cod. EFB02...)	EFB.4/.../... (cod. EFB04...)
	Rated current	[A]	24	24	24	32
Coloured partition	red, green, white		-	-	DFE.1+1/R (cod. DFE01R)	DFE.1+1/R (cod. DFE01R)
Test plug			SDD/1 (cod. DD001)	SDD/1 (cod. DD001)	SDD/1 (cod. DD001)	SDD/1 (cod. DD001)
Miniature fuse	\varnothing 5 x 20 mm		F5/... (cod. FN...)	F5/... (cod. FN...)	F5/... (cod. FN...)	F5/... (cod. FN...)
Non-polarized LED circuit	For voltage 12V 24V 48V AC/DC		CIL/12-48 (cod. SF518)	CIL/12-48 (cod. SF518)	CIL/12-48 (cod. SF518)	CIL/12-48 (cod. SF518)
	For voltage 115V 230V AC/DC		CIL/115-230 (cod. SF510)	CIL/115-230 (cod. SF510)	CIL/115-230 (cod. SF510)	CIL/115-230 (cod. SF510)
Single marking tag			CNU/10/51 (cod. NU1051S)	CNU/10/51 (cod. NU1051S)	CNU/10/51 (cod. NU1051S)	CNU/10/51 (cod. NU1051S)
Single marking tag for pitch insert			CNU/10/51 (cod. NU1051S)	CNU/10/51 (cod. NU1051S)	CNU/10/51 (cod. NU1051S)	CNU/10/51 (cod. NU1051S)
End bracket	Screw TH35		BT/3 (cod. BT003)	BT/3 (cod. BT003)	BT/3 (cod. BT003)	BT/3 (cod. BT003)
	Snap-fit TH35		BTO (cod. BT007)	BTO (cod. BT007)	BTO (cod. BT007)	BTO (cod. BT007)

Blank lined area for notes.

Spring-Clamp Terminal Blocks

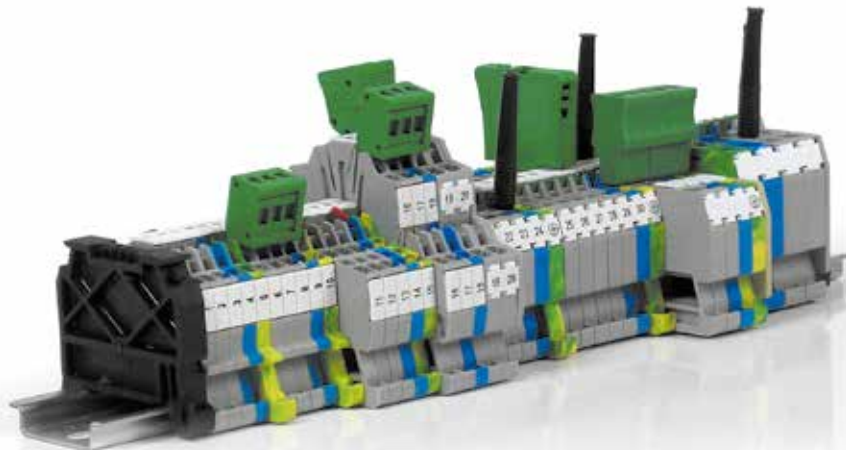

SPRING CLAMP



INERIS 16 ATEX 9002 UI	IECEX INE 16.0032U
I M2 Ex e I Mb	Ex e I Mb
II 2 G Ex E IIC Gb	Ex e IIC Gb

For the creation of high harness volumes, for conductors from 0.2 to 25 mm² and reduced current intensity values, CABUR proposes its range of spring-clamp terminal blocks.

To protect the clamping system, the insulating body includes a stopper which prevents the spring from going beyond the threshold of its elastic field, if it is activated by inexpert hands.

Adequate sizing of the wire introduction chamber, responding to the requirements of the IEC 60947-1 Standard, guarantees insertion of any type of conductor of the nominal size, also butted with a terminal.

The connection that results from this, in relation to the technology adopted, has the maximum reliability and safety thanks to the quality of the materials used and to the particular conformation of the components needed

for the purpose, avoiding damage to the strands of the conductors in the presence of unprepared flexible wires. The wire entry is perpendicular to the installation surface determining a further reduction of times and costs of the wiring operations above all where the spaces are particularly limited.

To connect together several contiguous elements, a practical and safe bridging system is available.

Terminal blocks with rated cross-sections of between 1.5 and 16 mm² have the possibility of being connected together in the most disparate ways thanks to our exclusive "Easy Bridge" rapid connection system (PTC), which combines efficiency, rapidity and flexibility providing at the same time a exceptional economic result; these characteristics together with the resulting **IPXXB intrinsic installation without the aid of further insulation protections** (of wires, terminal blocks and parallel connections), guarantees better connectivity than that offered by the competitors.



CNU/8



SHZ

MARKING SYSTEMS

In our marking system the same multiple numbering strip (SHZ) can be inserted on the sides of the terminal block or in the specific seats present in the upper part of the terminal block itself.

This means easy identification of each terminal block from every viewing angle within the electrical panel. The numbering can be done also with the single standard-type CNU/8 tags.

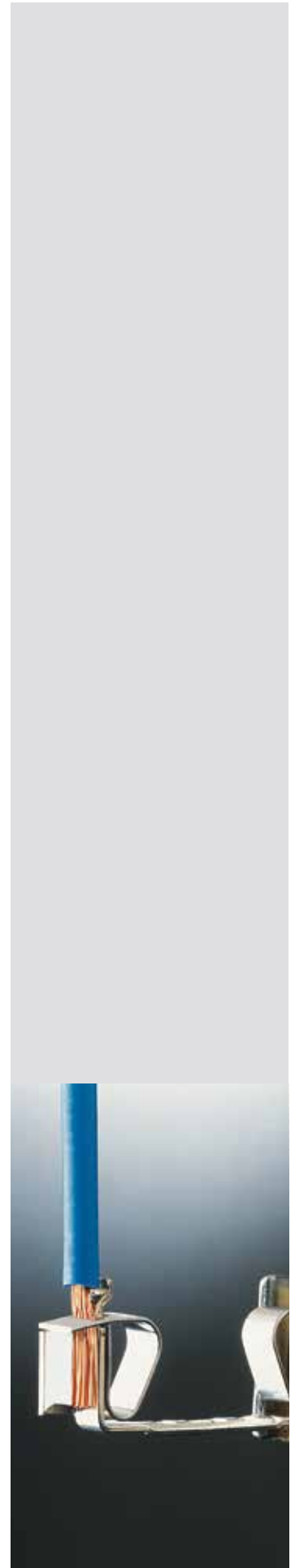



INERIS 16 ATEX 9002 U
I M2 Ex e I Mb
II 2 G Ex E IIC Gb

IECEX INE 16.0032U
Ex e I Mb
Ex e IIC Gb

(1) See chapter accessories for more details



GREY VERSION	CODE	HM400GR	HM410GR	HM420GR
	TYPE	HMM.1/GR	HMM.1/1+2/GR	HMM.1/2+2/GR
BLUE VERSION	CODE	HI400	HI410	HI420
	TYPE	HMM.1 (EX)I	HMM.1/1+2 (EX)I	HMM.1/2+2 (EX)I

TECHNICAL CHARACTERISTICS

Function/type	feed-through	feed-through	feed-through
Rated cross-section	[mm ²] 1.5	1.5	1.5
Connecting capacity	Flexible [mm ²] 0.2-2.5	0.2-2.5	0.2-2.5
	Rigid [mm ²] 0.2-2.5	0.2-2.5	0.2-2.5
	Max. flexible with ferrule - ferrule type [mm ²] 1.5-WP15/14	1.5-WP15/14	1.5-WP15/14
Electrical characteristics According to European standard IEC EN 60947-7-1	Max AC/DC Voltage [V] 500	500	500
	Max current with rated cross-section [A] 17.5	17.5	17.5
	Section Caliber B2	B2	B2
Electrical characteristics According to UL	Max AC/DC Voltage [V] 600	600	600
	Max current with rated cross-section [A] 15	15	15
	Section Min - Max [AWG] 26-14	26-14	26-14
Electrical characteristics According to ATEX directive and IEC ex standard	Max AC/DC voltage [V] 400	400	400
	Max current with rated cross-section [A] 17.5	17.5	17.5
	Operating temperature [°C] -40 +80	-40 +80	-40 +80
Rated impulse withstand voltage/pollution degree	8 KV / 3	8 KV / 3	8 KV / 3
Insulation stripping length [mm] 9	9	9	
Length [mm] 45	56	65	
Width [mm] 4.2	4.2	4.2	
Height mounted on TH35/7.5 [mm] 43	43	43	
Height mounted on TH35/15 [mm] 51	51	51	
Insulation material temperature index (EN 60216-1) [°C] 130	130	130	
Plastic material	polyamide UL94V-0	polyamide UL94V-0	polyamide UL94V-0

APPROVALS



ACCESSORIES

End section	Grey	HMT.1/PT/GR (cod. HM401GR)	HMT.1/1+2/PT/GR (cod. HM411GR)	HMT.1/2+2/PT/GR (cod. HM421GR)
	Blue	HMT.1/PT (Ex)I (cod. HI401)	HMT.1/1+2/PT (Ex)I (cod. HI411)	HMT.1/2+2/PT (Ex)I (cod. HI421)
	Thickness [mm] 1.5	1.5	1.5	1.5
Cross connection	PTC version (1)	PTC/1/... (cod. PTC01...)	PTC/1/... (cod. PTC01...)	PTC/1/... (cod. PTC01...)
	PTP version (1)	-	-	-
	Rated current [A] 17.5	17.5	17.5	17.5
Cross-connection identification strip	green	PTC/SP (cod. PTC0990)	PTC/SP (cod. PTC0990)	PTC/SP (cod. PTC0990)
Coloured partition	red	DFH/1/R (cod. DH01R)	DFH/2/R (cod. DH02R)	DFH/3/R (cod. DH03R)
Cross connection barrier	red	DFM/500 (cod. DF500)	DFM/500 (cod. DF500)	DFM/500 (cod. DF500)
Test plug	-	-	-	-
Modular test plug	-	SDH/4 (cod. DH004)	SDH/4 (cod. DH004)	SDH/4 (cod. DH004)
End section for modular test plug	-	SH4/PT (cod. DH401)	SH4/PT (cod. DH401)	SH4/PT (cod. DH401)
Numbering strip	-	SHZ/1 (cod. SH004)	SHZ/1 (cod. SH004)	SHZ/1 (cod. SH004)
Screwdriver for activation of the spring	-	CCH/2.5-4 (cod. CCH02)	CCH/2.5-4 (cod. CCH02)	CCH/2.5-4 (cod. CCH02)
Marking tag	-	SHZ/1 (cod. SH004)	SHZ/1 (cod. SH004)	SHZ/1 (cod. SH004)
End bracket	Snap-fit TH35 and G32	BTU (cod. BT005)	BTU (cod. BT005)	BTU (cod. BT005)
	Snap-fit TH35	BTO (cod. BT007)	BTO (cod. BT007)	BTO (cod. BT007)
	Screw TH35	BT/3 (cod. BT003)	BT/3 (cod. BT003)	BT/3 (cod. BT003)



INERIS 16 ATEX 9002 U
I M2 Ex e I Mb
II 2 G Ex E IIC Gb

IECEX INE 16.0032U
Ex e I Mb
Ex e IIC Gb

(1) See chapter accessories for more details

GREY VERSION	CODE	HM500GR	HM510GR	HM520GR
BLUE VERSION	CODE	HI500	HI510	HI520
	TYPE	HMM.2/GR	HMM.2/1+2/GR	HMM.2/2+2/GR
	TYPE	HMM.2 (EX)I	HMM.2/1+2 (EX)I	HMM.2/2+2 (EX)I



TECHNICAL CHARACTERISTICS

Function/type		feed-through	feed-through	feed-through
Rated cross-section	(mm ²)	2.5	2.5	2.5
Connecting capacity	Flexible (mm ²)	0.2-4	0.2-4	0.2-4
	Rigid (mm ²)	0.2-4	0.2-4	0.2-4
	Max. flexible with ferrule - ferrule type (mm ²)	2.5-WP25/14	2.5-WP25/14	2.5-WP25/14
Electrical characteristics According to European standard IEC EN 60947-7-1	Max AC/DC Voltage (V)	800	800	800
	Max current with rated cross-section (A)	24	24	24
	Section Caliber	A3	A3	A3
Electrical characteristics According to UL	Max AC/DC Voltage (V)	600	600	600
	Max current with rated cross-section (A)	20	20	20
	Section Min - Max (AWG)	24-12	24-12	24-12
Electrical characteristics According to ATEX directive and IEC ex standard	Max AC/DC voltage (V)	500	500	500
	Max current with rated cross-section (A)	24	24	24
	Operating temperature (°C)	-40 +80	-40 +80	-40 +80
Rated impulse withstand voltage/pollution degree		8 KV / 3	8 KV / 3	8 KV / 3
Insulation stripping length (mm)		10	10	10
Length (mm)		50	66	82
Width (mm)		5.2	5.2	5.2
Height mounted on TH35/7.5 (mm)		41	41	41
Height mounted on TH35/15 (mm)		49	49	49
Insulation material temperature index (EN 60216-1) (°C)		130	130	130
Plastic material		polyamide UL94V-0	polyamide UL94V-0	polyamide UL94V-0

APPROVALS



ACCESSORIES

End section	Grey	HMT.2/PT/GR (cod. HM501GR)	HMT.2/1+2/PT/GR (cod. HM511GR)	HMT.2/2+2/PT/GR (cod. HM521GR)
	Blue	HMT.2/PT (Ex)I (cod. HI501)	HMT.2/1+2/PT (Ex)I (cod. HI511)	HMT.2/2+2/PT (Ex)I (cod. HI521)
	Thickness (mm)	1.5	1.5	1.5
Cross connection	PTC version (1)	PTC/03/... (cod. PTC03...)	PTC/03/... (cod. PTC03...)	PTC/03/... (cod. PTC03...)
	PTP version (1)	PTP/03/... (cod. PTP03...)	PTP/03/... (cod. PTP03...)	PTP/03/... (cod. PTP03...)
	Rated current (A)	24	24	24
Cross-connection identification strip	green	PTC/SP (cod. PTC0990)	PTC/SP (cod. PTC0990)	PTC/SP (cod. PTC0990)
Coloured partition	red	DFH/1/R (cod. DH01R)	DFH/2/R (cod. DH02R)	DFH/3/R (cod. DH03R)
Cross connection barrier	red	-	-	-
Test plug		SDD/1 (cod. DD001)	SDD/1 (cod. DD001)	SDD/1 (cod. DD001)
Modular test plug		SDH/5 (cod. DH005)	SDH/5 (cod. DH005)	SDH/5 (cod. DH005)
End section for modular test plug		SH5/PT (cod. DH501)	SH5/PT (cod. DH501)	SH5/PT (cod. DH501)
Numbering strip		CNU/8/51 (cod. NU0851S)	CNU/8/51 (cod. NU0851S)	CNU/8/51 (cod. NU0851S)
Screwdriver for activation of the spring		CCH/2.5-4 (cod. CCH02)	CCH/2.5-4 (cod. CCH02)	CCH/2.5-4 (cod. CCH02)
Marking tag		CNU/8/51 (cod. NU0851S)	CNU/8/51 (cod. NU0851S)	CNU/8/51 (cod. NU0851S)
End bracket	Snap-fit TH35 and G32	BTU (cod. BT005)	BTU (cod. BT005)	BTU (cod. BT005)
	Snap-fit TH35	BTO (cod. BT007)	BTO (cod. BT007)	BTO (cod. BT007)
	Screw TH35	BT/3 (cod. BT003)	BT/3 (cod. BT003)	BT/3 (cod. BT003)



(1) See chapter accessories for more details

GREY VERSION	CODE TYPE	HMS20GR HMM.2/1+2/S/GR	HM170GR HMM.2/2+2/A/GR	HMS10GR HMM.2/2+2/S/GR
BLUE VERSION	CODE TYPE			

TECHNICAL CHARACTERISTICS

Function/type		disconnect	disconnect (open version)	disconnect
Rated cross-section	(mm ²)	2.5	2.5	2.5
Connecting capacity	Flexible (mm ²)	0.2-4	0.2-4	0.2-4
	Rigid (mm ²)	0.2-4	0.2-4	0.2-4
	Max. flexible with ferrule - ferrule type (mm ²)	2.5-WP25/14	2.5-WP25/14	2.5-WP25/14
Electrical characteristics According to European standard IEC EN 60947-7-1	Max AC/DC Voltage (V)	400	400	400
	Max current with rated cross-section (A)	16	16	16
	Section Caliber	A3	A3	A3
Electrical characteristics According to UL	Max AC/DC Voltage (V)	-	-	-
	Max current with rated cross-section (A)	-	-	-
	Section Min - Max (AWG)	-	-	-
Electrical characteristics According to ATEX directive and IEC ex standard	Max AC/DC voltage (V)	-	-	-
	Max current with rated cross-section (A)	-	-	-
	Operating temperature (°C)	-	-	-
Rated impulse withstand voltage/pollution degree		6 KV / 3	4 KV / 3	6 KV / 3
Insulation stripping length (mm)		10	10	10
Length (mm)		66	82	82
Width (mm)		5.2	5.2	5.2
Height mounted on TH35/7.5 (mm)		48	37	48
Height mounted on TH35/15 (mm)		56	45	56
Insulation material temperature index (EN 60216-1) (°C)		130	130	130
Plastic material		polyamide UL94V-0	polyamide UL94V-0	polyamide UL94V-0

APPROVALS



ACCESSORIES

End section	Grey	HMT.2/1+2/PT/GR (cod. HM511GR)	HMT.2/2+2/PT/GR (cod. HM521GR)	HMT.2/2+2/PT/GR (cod. HM521GR)
	Blue	-	-	-
	Thickness (mm)	1.5	1.5	1.5
Cross connection	PTC version (1)	-	-	-
	PTP version (1)	-	-	-
	Rated current (A)	-	-	-
Cross-connection identification strip	green	-	-	-
Coloured partition	red	DFH/2/R (cod. DH02R)	DFH/3/R (cod. DH03R)	DFH/3/R (cod. DH03R)
Cross connection barrier	red	-	-	-
Test plug		SDD/1 (cod. DD001)	SDD/1 (cod. DD001)	SDD/1 (cod. DD001)
Modular test plug		SDH/5 (cod. DH005)	SDH/5 (cod. DH005)	SDH/5 (cod. DH005)
End section for modular test plug		SH5/PT (cod. DH501)	SH5/PT (cod. DH501)	SH5/PT (cod. DH501)
Numbering strip		CNU/8/51 (cod. NU0851S)	CNU/8/51 (cod. NU0851S)	CNU/8/51 (cod. NU0851S)
Screwdriver for activation of the spring		CCH/2.5-4 (cod. CCH02)	CCH/2.5-4 (cod. CCH02)	CCH/2.5-4 (cod. CCH02)
Marking tag		CNU/8/51 (cod. NU0851S)	CNU/8/51 (cod. NU0851S)	CNU/8/51 (cod. NU0851S)
End bracket	Snap-fit TH35 and G32	BTU (cod. BT005)	BTU (cod. BT005)	BTU (cod. BT005)
	Snap-fit TH35	BTO (cod. BT007)	BTO (cod. BT007)	BTO (cod. BT007)
	Screw TH35	BT/3 (cod. BT003)	BT/3 (cod. BT003)	BT/3 (cod. BT003)



INERIS 16 ATEX 9002 U
I M2 Ex e I Mb
II 2 G Ex E IIC Gb

IECEX INE 16.0032U
Ex e I Mb
Ex e IIC Gb

(1) See chapter accessories for more details

GREY VERSION	CODE TYPE	HM320GR	HM330GR	HM340GR
		HMM.6/GR	HMM.10/GR	HMM.16/GR
BLUE VERSION	CODE TYPE	HI320	HI330	HI340
		HMM.6 (EX)I	HMM.10 (EX)I	HMM.16 (EX)I

TECHNICAL CHARACTERISTICS

Function/type		feed-through	feed-through	feed-through
Rated cross-section	[mm ²]	6	10	16
Connecting capacity	Flexible	[mm ²]	0.2-10	1.5-16
	Rigid	[mm ²]	0.2-10	1.5-16
	Max. flexible with ferrule - ferrule type	[mm ²]	6-WP60/20	10-WP100/21
Electrical characteristics According to European standard IEC EN 60947-7-1	Max AC/DC Voltage	[V]	800	1000
	Max current with rated cross-section	[A]	41	57
	Section	Caliber	A5	A6
Electrical characteristics According to UL	Max AC/DC Voltage	[V]	600	600
	Max current with rated cross-section	[A]	41	57
	Section Min - Max	[AWG]	24 - 8	20 - 6
Electrical characteristics According to ATEX directive and IEC ex standard	Max AC/DC voltage	[V]	500	500
	Max current with rated cross-section	[A]	41	57
	Operating temperature	[°C]	-40 +80	-40 +80
Rated impulse withstand voltage/pollution degree		8 KV / 3	8 KV / 3	12 KV / 3
Insulation stripping length	[mm]	13	18	18
Length	[mm]	62	71	80
Width	[mm]	8.2	10	12
Height mounted on TH35/7.5	[mm]	48	53	56
Height mounted on TH35/15	[mm]	56	61	64
Insulation material temperature index (EN 60216-1)	[°C]	130	130	130
Plastic material		polyamide UL94V-0	polyamide UL94V-0	polyamide UL94V-0

APPROVALS



ACCESSORIES

End section	Grey	HMT.6/PT/GR (cod. HM321GR)	HMT.10/PT/GR (cod. HM331GR)	HMT.16/PT/GR (cod. HM341GR)
	Blue	HMT.6/PT (Ex)i (cod. HI321)	HMT.10/PT (Ex)i (cod. HI331)	HMT.16/PT (Ex)i (cod. HI341)
	Thickness	[mm]	1.5	1.5
Cross connection	PTC version (1)	PTC/8/... (cod. PTC08...)	PTC/11/... (cod. PTC11...)	PTC/16/... (cod. PTC16...)
	PTP version (1)	-	-	-
	Rated current	[A]	41	57
Cross-connection identification strip	green	PTC/SP (cod. PTC0990)	-	-
Coloured partition	red	DFH/1/R (cod. DH01R)	DFH/4/R (cod. DH04R)	DFH/4/R (cod. DH04R)
Cross connection barrier	red	-	-	-
Test plug		SDD/1 (cod. DD001)	SDD/1 (cod. DD001)	SDD/1 (cod. DD001)
Modular test plug		-	-	-
End section for modular test plug		-	-	-
Numbering strip		-	-	-
Screwdriver for activation of the spring		CCH/6 (cod. CCH06)	CCH/6 (cod. CCH06)	CCH/6 (cod. CCH06)
Marking tag		CNU/8/51 (cod. NU0851S)	CNU/8/51 (cod. NU0851S)	CNU/8/51 (cod. NU0851S)
End bracket	Snap-fit TH35 and G32	BTU (cod. BT005)	BTU (cod. BT005)	BTU (cod. BT005)
	Snap-fit TH35	BTO (cod. BT007)	BTO (cod. BT007)	BTO (cod. BT007)
	Screw TH35	BT/3 (cod. BT003)	BT/3 (cod. BT003)	BT/3 (cod. BT003)

- connectable with the terminal blocks: HMM.2/GR, HMM.2/1+2/GR, HMM.2/2+2/GR, HMS.2/GR, HMFA.2/GR, HMM.4/GR, HMM.4/1+2/GR, HMM.4/2+2/GR, HMM.6/GR

[1] value referred to the terminal and not to the potential distributor

[2] See chapter accessories for more details

[3] The number of poles to be used shall be equal to the number of terminal blocks to be connected, including the distribution terminal block +1 to allow the connection to the distribution terminal block the second pin of the PTC jumper shall be trimmed off.

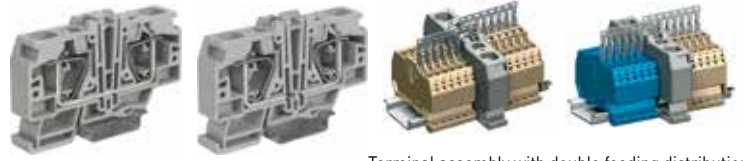

Terminal assembly with double feeding distribution

CONNECTION DIAGRAM DISTRIBUTOR TERMINAL BLOCKS HMR.16/GR A HMR.16/D/GR

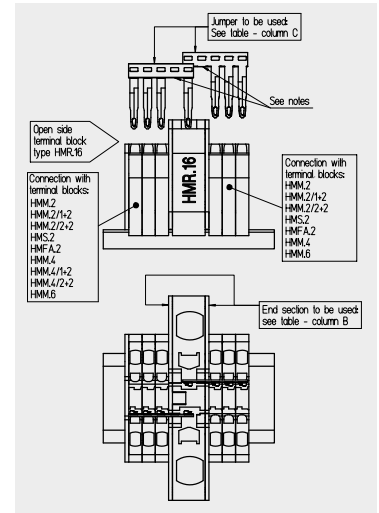

Connection on 2 sides

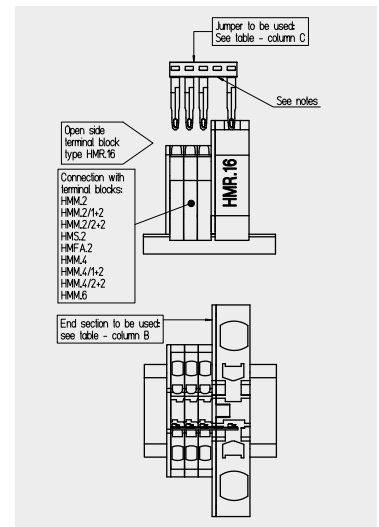

Connection on open sides

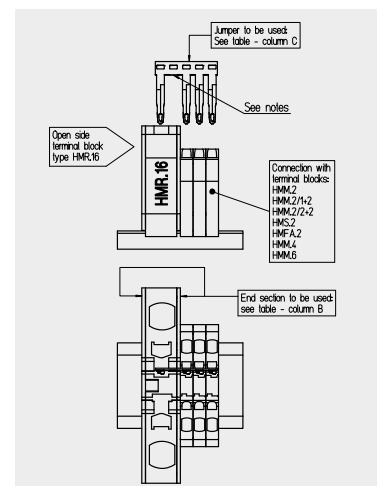

Connection on closed side of distributor

SINGLE POWER SUPPLY VERSION	CODE	HM350GR	
	TYPE		HMR.16/GR
DOUBLE SUPPLY VERSION	CODE	HM360GR	
	TYPE		HMR.16/D/GR

TECHNICAL CHARACTERISTICS

Function/type		feed-through
Rated cross-section	(mm ²)	16
Connecting capacity	Flexible	(mm ²) 1.5-25
	Rigid	(mm ²) 1.5-25
	Max.flexible with ferrule - ferrule type	(mm ²) 16-WP160/22
Electrical characteristics According to European standard IEC EN 60947-7-1	Max AC/DC Voltage	(V) 800
	Max current with rated cross-section	(A) 76 [1]
	Section Caliber	A7
Electrical characteristics According to UL	Max AC/DC Voltage	(V) 600
	Max current with rated cross-section	(A) 30
	Section Min-Max	(AWG) 18-4
Rated impulse withstand voltage/pollution degree		12 KV / 3
Insulation stripping length	(mm)	18
Length	(mm)	80
Width	(mm)	12.8
Height mounted on TH35/7,5	(mm)	50
Height mounted on TH35/15	(mm)	57
Insulation material temperature index (EN 60216-1)	(°C)	130
Plastic material		polyamide UL94V-0

APPROVALS



ACCESSORIES

End section	Thickness	(mm)	see table
	PTC version [2] [3]		see table
Cross connection	PTP version [2] [3]		see table
	Rated current	(A)	see table
Cross-connection identification strip (100 mm)			-
Coloured partition	red		DFH/4/R (cod. DH04R)
Cross connection barrier	red		-
Test plug			SDD/1 (cod. DD001)
Modular test plug			-
Numbering strip			-
Screwdriver for activation of the spring			CCH/6 (cod. CCH06)
Marking tag			CNU/8/51 (cod. NU0851S)
			-
	Snap-fit TH35 and G32		BTU (cod. BT005)
End bracket	Snap-fit TH35		BTO (cod. BT007)
	Screw TH35		BT/3 (cod. BT003)

TERMINAL BLOCK CONNECTED TO THE DISTRIBUTOR	HMM.2/GR	HMM.4/GR	HMM.6/GR
HMM.2/1+2/GR		HMM.4/1+2/GR	-
HMM.2/2+2/GR		HMM.4/2+2/GR	-
HMS.2/GR		-	-
HMFA.2/GR		-	-
End section	HMR.16-2/PT/GR (cod. HM352GR)	HMR.16-4/PT/GR (cod. HM354GR)	HMR.16-6/PT/GR (cod. HM356GR)
Thickness (mm)	1.5	1.5	1.5
Permanent cross connection PTC	PTC/03/... (cod. PTC03...)	PTC/05/... (cod. PTC05...)	PTC/08/... (cod. PTC08...)
Permanent cross connection PTP	PTP/03/... (cod. PTP03...)	PTP/05/... (cod. PTP05...)	-
Total current carrying capacity (A)	24	32	41



Ex INERIS 16 ATEX 9002 U
I M2 Ex e I Mb
II 2 G Ex E IIC Gb

IECEX INE 16.0032U
Ex e I Mb
Ex e IIC Gb

(1) See chapter accessories for more details

YELLOW/GREEN VERSION		CODE	HT400	HT410	HT420
		TYPE	HTE.1	HTE.1/1+2	HTE.1/2+2
TECHNICAL CHARACTERISTICS					
Function/type			earth	earth	earth
Rated cross-section		[mm ²]	1.5	1.5	1.5
Connecting capacity	Flexible	[mm ²]	0.2-2.5	0.2-2.5	0.2-2.5
	Rigid	[mm ²]	0.2-2.5	0.2-2.5	0.2-2.5
	Max. flexible with ferrule - ferrule type	[mm ²]	1.5-WP15/14	1.5-WP15/14	1.5-WP15/14
Electrical characteristics According to European standard IEC EN 60947-7-2	Max AC/DC Voltage	[V]	-	-	-
	Max current with rated cross-section	[A]	-	-	-
	Section	Caliber	B2	B2	B2
Electrical characteristics According to UL	Max AC/DC Voltage	[V]	600	600	600
	Max current with rated cross-section	[A]	-	-	-
	Section Min - Max	[AWG]	26-14	26-14	26-14
Electrical characteristics According to ATEX directive and IEC ex standard	Max AC/DC voltage	[V]	400	400	400
	Max current with rated cross-section	[A]	17.5	17.5	17.5
	Operating temperature	[°C]	-40 +80	-40 +80	-40 +80
Rated impulse withstand voltage/pollution degree			8 KV / 3	8 KV / 3	8 KV / 3
Insulation stripping length		[mm]	9	9	9
Length		[mm]	50	61	65
Width		[mm]	4.2	4.2	4.2
Height mounted on TH35/7.5		[mm]	43	43	43
Height mounted on TH35/15		[mm]	51	51	51
Insulation material temperature index (EN 60216-1)		[°C]	130	130	130
Plastic material			polyamide UL94V-0	polyamide UL94V-0	polyamide UL94V-0
APPROVALS					
ACCESSORIES					
End section	Grey		HMT.1/PT/GR (cod. HM401GR)	HMT.1/1+2/PT/GR (cod. HM411GR)	HMT.1/2+2/PT/GR (cod. HM421GR)
	Blue		-	-	-
Cross connection	Thickness	[mm]	1.5	1.5	1.5
	PTC version (1)		PTC/1/... (cod. PTC01...)	PTC/1/... (cod. PTC01...)	PTC/1/... (cod. PTC01...)
	PTP version (1)		-	-	-
Cross-connection identification strip	Rated current	[A]	17.5	17.5	17.5
	green		PTC/SP (cod. PTC0990)	PTC/SP (cod. PTC0990)	PTC/SP (cod. PTC0990)
Coloured partition	red		DFH/1/R (cod. DH01R)	DFH/2/R (cod. DH02R)	DFH/3/R (cod. DH03R)
Cross connection barrier	red		DFM/500 (cod. DF500)	DFM/500 (cod. DF500)	DFM/500 (cod. DF500)
Test plug			-	-	-
Modular test plug			-	-	-
End section for modular test plug			-	-	-
Numbering strip			SHZ/1 (cod. SH004)	SHZ/1 (cod. SH004)	SHZ/1 (cod. SH004)
Screwdriver for activation of the spring			CCH/2.5-4 (cod. CCH02)	CCH/2.5-4 (cod. CCH02)	CCH/2.5-4 (cod. CCH02)
Marking tag			SHZ/1 (cod. SH004)	SHZ/1 (cod. SH004)	SHZ/1 (cod. SH004)
End bracket	Snap-fit TH35 and G32		BTU (cod. BT005)	BTU (cod. BT005)	BTU (cod. BT005)
	Snap-fit TH35		BTO (cod. BT007)	BTO (cod. BT007)	BTO (cod. BT007)
	Screw TH35		BT/3 (cod. BT003)	BT/3 (cod. BT003)	BT/3 (cod. BT003)



INERIS 16 ATEX 9002 U
I M2 Ex e I Mb
II 2 G Ex E IIC Gb

IECEX INE 16.0032U
Ex e I Mb
Ex e IIC Gb

(1) See chapter accessories for more details







YELLOW/GREEN VERSION		CODE	HT500	HT510	HT520
		TYPE	HTE.2	HTE.2/1+2	HTE.2/2+2
TECHNICAL CHARACTERISTICS					
Function/type			earth	earth	earth
Rated cross-section		[mm ²]	2.5	2.5	2.5
Connecting capacity	Flexible	[mm ²]	0.2-4	0.2-4	0.2-4
	Rigid	[mm ²]	0.2-4	0.2-4	0.2-4
	Max. flexible with ferrule - ferrule type	[mm ²]	2.5-WP25/14	2.5-WP25/14	2.5-WP25/14
Electrical characteristics According to European standard IEC EN 60947-7-2	Max AC/DC Voltage	[V]	-	-	-
	Max current with rated cross-section	[A]	-	-	-
	Section	Caliber	A3	A3	A3
Electrical characteristics According to UL	Max AC/DC Voltage	[V]	600	600	600
	Max current with rated cross-section	[A]	-	-	-
	Section Min - Max	[AWG]	24-12	24-12	24-12
Electrical characteristics According to ATEX directive and IEC ex standard	Max AC/DC voltage	[V]	500	500	500
	Max current with rated cross-section	[A]	24	24	24
	Operating temperature	[°C]	-40 +80	-40 +80	-40 +80
Rated impulse withstand voltage/pollution degree			8 KV / 3	8 KV / 3	8 KV / 3
Insulation stripping length		[mm]	10	10	10
Length		[mm]	54	70	82
Width		[mm]	5.2	5.2	5.2
Height mounted on TH35/7.5		[mm]	41	41	41
Height mounted on TH35/15		[mm]	49	49	49
Insulation material temperature index (EN 60216-1)		[°C]	130	130	130
Plastic material			polyamide UL94V-0	polyamide UL94V-0	polyamide UL94V-0
APPROVALS					
ACCESSORIES					
End section	Grey		HMT.2/PT/GR (cod. HM501GR)	HMT.2/1+2/PT/GR (cod. HM511GR)	HMT.2/2+2/PT/GR (cod. HM521GR)
	Blue		-	-	-
Cross connection	Thickness	[mm]	1.5	1.5	1.5
	PTC version (1)		PTC/03/... (cod. PTC03...)	PTC/03/... (cod. PTC03...)	PTC/03/... (cod. PTC03...)
	PTP version (1)		PTP/03/... (cod. PTP03...)	PTP/03/... (cod. PTP03...)	PTP/03/... (cod. PTP03...)
	Rated current	[A]	24	24	24
Cross-connection identification strip	green		PTC/SP (cod. PTC0990)	PTC/SP (cod. PTC0990)	PTC/SP (cod. PTC0990)
Coloured partition	red		DFH/1/R (cod. DH01R)	DFH/2/R (cod. DH02R)	DFH/3/R (cod. DH03R)
Cross connection barrier	red		-	-	-
Test plug			SDD/1 (cod. DD001)	SDD/1 (cod. DD001)	SDD/1 (cod. DD001)
Modular test plug			-	-	-
End section for modular test plug			-	-	-
Numbering strip			CNU/8/51 (cod. NU0851S)	CNU/8/51 (cod. NU0851S)	CNU/8/51 (cod. NU0851S)
Screwdriver for activation of the spring			CCH/2.5-4 (cod. CCH02)	CCH/2.5-4 (cod. CCH02)	CCH/2.5-4 (cod. CCH02)
Marking tag			CNU/8/51 (cod. NU0851S)	CNU/8/51 (cod. NU0851S)	CNU/8/51 (cod. NU0851S)
End bracket	Snap-fit TH35 and G32		BTU (cod. BT005)	BTU (cod. BT005)	BTU (cod. BT005)
	Snap-fit TH35		BTO (cod. BT007)	BTO (cod. BT007)	BTO (cod. BT007)
	Screw TH35		BT/3 (cod. BT003)	BT/3 (cod. BT003)	BT/3 (cod. BT003)



 INERIS 16 ATEX 9002 U
I M2 Ex e I Mb
II 2 G Ex E IIC Gb

IECEX INE 16.0032U
Ex e I Mb
Ex e IIC Gb

(1) See chapter accessories for more details

YELLOW/GREEN VERSION		CODE	HT250	HT260	HT270
		TYPE	HTE.4	HTE.4/1+2	HTE.4/2+2
TECHNICAL CHARACTERISTICS					
Function/type			earth	earth	earth
Rated cross-section		[mm ²]	4	4	4
Connecting capacity	Flexible	[mm ²]	0.2-6	0.2-6	0.2-6
	Rigid	[mm ²]	0.2-6	0.2-6	0.2-6
	Max. flexible with ferrule - ferrule type	[mm ²]	4-WP40/16	4-WP40/16	4-WP40/16
Electrical characteristics According to European standard IEC EN 60947-7-2	Max AC/DC Voltage	[V]	-	-	-
	Max current with rated cross-section	[A]	-	-	-
	Section	Caliber	A4	A4	A4
Electrical characteristics According to UL	Max AC/DC Voltage	[V]	600	600	600
	Max current with rated cross-section	[A]	-	-	-
	Section Min - Max	[AWG]	24-10	24-10	24-10
Electrical characteristics According to ATEX directive and IEC ex standard	Max AC/DC voltage	[V]	500	500	500
	Max current with rated cross-section	[A]	32	32	32
	Operating temperature	[°C]	-40 +80	-40 +80	-40 +80
Rated impulse withstand voltage/pollution degree			8 KV / 3	8 KV / 3	8 KV / 3
Insulation stripping length		[mm]	12	12	12
Length		[mm]	58	78	98
Width		[mm]	6.2	6.2	6.2
Height mounted on TH35/7.5		[mm]	45	45	45
Height mounted on TH35/15		[mm]	52	52	52
Insulation material temperature index (EN 60216-1)		[°C]	130	130	130
Plastic material			polyamide UL94V-0	polyamide UL94V-0	polyamide UL94V-0
APPROVALS					
ACCESSORIES					
End section	Grey		HMT.4/PT/GR (cod. HM251GR)	HMT.4/1+2/PT/GR (cod. HM211GR)	HMT.4/2+2/PT/GR (cod. HM221GR)
	Blue		-	-	-
Cross connection	Thickness	[mm]	1.5	1.5	1.5
	PTC version (1)		PTC/5/... (cod. PTC05...)	PTC/5/... (cod. PTC05...)	PTC/5/... (cod. PTC05...)
	PTP version (1)		PTP/5/... (cod. PTP05...)	PTP/5/... (cod. PTP05...)	PTP/5/... (cod. PTP05...)
	Rated current	[A]	32	32	32
Cross-connection identification strip	green		PTC/SP (cod. PTC0990)	PTC/SP (cod. PTC0990)	PTC/SP (cod. PTC0990)
Coloured partition	red		DFH/1/R (cod. DH01R)	DFH/1/R (cod. DH01R)	DFH/1/R (cod. DH01R)
Cross connection barrier	red		-	-	-
Test plug			SDD/1 (cod. DD001)	SDD/1 (cod. DD001)	SDD/1 (cod. DD001)
Modular test plug			-	-	-
End section for modular test plug			-	-	-
Numbering strip			CNU/8/61 (cod. NU0861S)	CNU/8/61 (cod. NU0861S)	CNU/8/61 (cod. NU0861S)
Screwdriver for activation of the spring			CCH/2.5-4 (cod. CCH02)	CCH/2.5-4 (cod. CCH02)	CCH/2.5-4 (cod. CCH02)
Marking tag			CNU/8/61 (cod. NU0861S)	CNU/8/61 (cod. NU0861S)	CNU/8/61 (cod. NU0861S)
End bracket	Snap-fit TH35 and G32		BTU (cod. BT005)	BTU (cod. BT005)	BTU (cod. BT005)
	Snap-fit TH35		BTO (cod. BT007)	BTO (cod. BT007)	BTO (cod. BT007)
	Screw TH35		BT/3 (cod. BT003)	BT/3 (cod. BT003)	BT/3 (cod. BT003)



INERIS 16 ATEX 9002 U
 I M2 Ex e I Mb
 II 2 G Ex E IIC Gb

IECEx INE 16.0032U
 Ex e I Mb
 Ex e IIC Gb

(1) See chapter accessories for more details

YELLOW/GREEN VERSION		CODE	HT320	HT330	HT340
		TYPE	HTE.6	HTE.10	HTE.16
TECHNICAL CHARACTERISTICS					
Function/type			earth	earth	earth
Rated cross-section		[mm ²]	6	10	16
Connecting capacity	Flexible	[mm ²]	0.2-10	1.5-16	1.5-25
	Rigid	[mm ²]	0.2-10	1.5-16	1.5-25
	Max. flexible with ferrule - ferrule type	[mm ²]	6-WP60/20	10-WP100/21	16-WP160/22
Electrical characteristics According to European standard IEC EN 60947-7-2	Max AC/DC Voltage	[V]	-	-	-
	Max current with rated cross-section	[A]	-	-	-
	Section	Caliber	A5	A6	A7
Electrical characteristics According to UL	Max AC/DC Voltage	[V]	600	600	600
	Max current with rated cross-section	[A]	-	-	-
	Section Min - Max	[AWG]	24-8	20-6	18-4
Electrical characteristics According to ATEX directive and IEC ex standard	Max AC/DC voltage	[V]	500	500	630
	Max current with rated cross-section	[A]	41	57	76
	Operating temperature	[°C]	-40 +80	-40 +80	-40 +80
Rated impulse withstand voltage/pollution degree			8 KV / 3	12 KV / 3	12 KV / 3
Insulation stripping length		[mm]	13	18	18
Length		[mm]	62	71	80
Width		[mm]	8.2	10	12
Height mounted on TH35/7.5		[mm]	48	53	56
Height mounted on TH35/15		[mm]	56	61	64
Insulation material temperature index (EN 60216-1)		[°C]	130	130	130
Plastic material			polyamide UL94V-0	polyamide UL94V-0	polyamide UL94V-0
APPROVALS					
ACCESSORIES					
End section	Grey		HMT.6/PT/GR (cod. HM321GR)	HMT.10/PT (cod. HM331GR)	HMT.16/PT (cod. HM341GR)
	Blue		-	-	-
Cross connection	Thickness	[mm]	1.5	1.5	1.5
	PTC version (1)		PTC/8/... (cod.PTC08...)	PTC/11/... (cod. PTC11...)	PTC/16/... (cod. PTC16...)
	PTP version (1)		-	-	-
Cross-connection identification strip	Rated current	[A]	41	57	76
	green		PTC/SP (cod.PTC0990)	-	-
Coloured partition	red		DFH/1/R (cod. DH01R)	DFH/4/R (cod. DH04R)	DFH/4/R (cod. DH04R)
Cross connection barrier	red		-	-	-
Test plug			SDD/1 (cod. DD001)	SDD/1 (cod. DD001)	SDD/1 (cod. DD001)
Modular test plug			-	-	-
End section for modular test plug			-	-	-
Numbering strip			-	-	-
Screwdriver for activation of the spring			CCH/6 (cod. CCH06)	CCH/6 (cod. CCH06)	CCH/6 (cod. CCH06)
Marking tag			CNU/8/51 (cod. NU0851S)	CNU/8/51 (cod. NU0851S)	CNU/8/51 (cod. NU0851S)
			-	-	-
End bracket	Snap-fit TH35 and G32		BTU (cod. BT005)	BTU (cod. BT005)	BTU (cod. BT005)
	Snap-fit TH35		BTO (cod. BT007)	BTO (cod. BT007)	BTO (cod. BT007)
	Screw TH35		BT/3 (cod. BT003)	BT/3 (cod. BT003)	BT/3 (cod. BT003)



INERIS 16 ATEX 9002 U
I M2 Ex e I Mb
II 2 G Ex e IIC Gb

IECEx INE 16.0032U
Ex e I Mb
Ex e IIC Gb

(1) See chapter accessories for more details

GREY VERSION	CODE	HD200GR	HD120GR
	TYPE	HMD.1/GR	HMD 1/CI/GR
BLUE VERSION	CODE	HD300	
	TYPE	HMD.1 (EX)I	

TECHNICAL CHARACTERISTICS

Function/type		two-level feed-through	two-levels and internal connection
Rated cross-section	(mm ²)	1.5	1.5
Connecting capacity	Flexible (mm ²)	0.2-2.5	0.2-2.5
	Rigid (mm ²)	0.2-2.5	0.2-2.5
	Max. flexible with ferrule - ferrule type (mm ²)	1.5-WP15/14	1.5-WP15/14
Electrical characteristics According to European standard IEC EN 60947-7-1	Max AC/DC Voltage (V)	500	500
	Max current with rated cross-section (A)	16	16
	Section Caliber	B2	B2
Electrical characteristics According to UL	Max AC/DC Voltage (V)	600	600
	Max current with rated cross-section (A)	15	15
	Section Min - Max (AWG)	26-14	26-14
Electrical characteristics According to ATEX directive and IEC ex standard	Max AC/DC voltage (V)	400	400
	Max current with rated cross-section (A)	24	24
	Operating temperature (°C)	-40 +80	-40 +80
Rated impulse withstand voltage/pollution degree		6 KV / 3	6 KV / 3
Insulation stripping length (mm)		10	10
Length (mm)		73	73
Width (mm)		4.2	4.2
Height mounted on TH35/7.5 (mm)		59	59
Height mounted on TH35/15 (mm)		67	67
Insulation material temperature index (EN 60216-1) (°C)		130	130
Plastic material		polyamide UL94V-0	polyamide UL94V-0

APPROVALS

ACCESSORIES

End section	Grey	HMD.1/PT/GR (cod. HD201GR)	HMD.1/PT/GR (cod. HD201GR)
	Blue	HMD.1/PT (Ex)I (cod. HD301)	HMD.1/PT (Ex)I (cod. HD301)
	Thickness (mm)	1.5	1.5
Cross connection	PTC version (1)	PTC/1/... (cod. PTC01...)	PTC/1/... (cod. PTC01...)
	PTP version (1)	-	-
	Rated current (A)	17.5	17.5
Cross-connection identification strip	green	PTC/SP (cod. PTC0990)	PTC/SP (cod. PTC0990)
Internal cross connection (removable)		-	-
Coloured partition	red	DFU/07/R (cod. DU07R)	DFU/07/R (cod. DU07R)
Cross connection barrier	red	DFM/500 (cod. DF500)	DFM/500 (cod. DF500)
Test plug		-	-
Modular test plug		SDH/4 (cod. DH004)	SDH/4 (cod. DH004)
End section for modular test plug		SH4/PT (cod. DH401)	SH4/PT (cod. DH401)
Numbering strip		SHZ/1 (cod. SH004)	SHZ/1 (cod. SH004)
Screwdriver for activation of the spring		CCH/2.5-4 (cod. CCH02)	CCH/2.5-4 (cod. CCH02)
Marking tag		SHZ/1 (cod. SH004)	SHZ/1 (cod. SH004)
		-	-
		-	-
End bracket	Snap-fit TH35 and G32	BTU (cod. BT005)	BTU (cod. BT005)
	Snap-fit TH35	BTO (cod. BT007)	BTO (cod. BT007)
	Screw TH35	BT/3 (cod. BT003)	BT/3 (cod. BT003)



INERIS 16 ATEX 9002 U
I M2 Ex e I Mb
II 2 G Ex e IIC Gb

IECEX INE 16.0032U
Ex e I Mb
Ex e IIC Gb

(1) See chapter accessories for more details



GREY VERSION	CODE	HD400GR	HD450GR
	TYPE	HMD.2N/GR	HMD.2N/CI/GR
BLUE VERSION	CODE	HD410	
	TYPE	HMD.2N (EX)I	

TECHNICAL CHARACTERISTICS

Function/type		two-level feed-through	two-levels and internal connection
Rated cross-section	(mm ²)	2,5	2,5
Connecting capacity	Flexible (mm ²)	0.2-2.5	0.2-2.5
	Rigid (mm ²)	0.2-2.5	0.2-2.5
	Max. flexible with ferrule - ferrule type (mm ²)	1.5-WP15/14	1.5-WP15/14
Electrical characteristics According to European standard IEC EN 60947-7-1	Max AC/DC Voltage (V)	630	630
	Max current with rated cross-section (A)	24	24
	Section (Caliber)	B2	B2
Electrical characteristics According to UL	Max AC/DC Voltage (V)	600	600
	Max current with rated cross-section (A)	15	15
	Section Min - Max (AWG)	26-14	26-14
Electrical characteristics According to ATEX directive and IEC ex standard	Max AC/DC voltage (V)	400	400
	Max current with rated cross-section (A)	24	24
	Operating temperature (°C)	-40 +80	-40 +80
Rated impulse withstand voltage/pollution degree		8 KV / 3	8 KV / 3
Insulation stripping length (mm)		10	10
Length (mm)		73	73
Width (mm)		5.2	5.2
Height mounted on TH35/7.5 (mm)		59	59
Height mounted on TH35/15 (mm)		67	67
Insulation material temperature index (EN 60216-1) (°C)		130	130
Plastic material		polyamide UL94V-0	polyamide UL94V-0

APPROVALS

ACCESSORIES

End section	Grey	HMD.1/PT/GR (cod. HD201GR)	HMD.1/PT/GR (cod. HD201GR)
	Blue	HMD.1/PT (Ex)I (cod. HD301)	HMD.1/PT (Ex)I (cod. HD301)
	Thickness (mm)	1,5	1,5
Cross connection	PTC version (1)	PTC/03/... (cod. PTC03...)	PTC/03/... (cod. PTC03...)
	PTP version (1)	PTP/03/... (cod. PTP03...)	PTP/03/... (cod. PTP03...)
	Rated current (A)	24	24
Cross-connection identification strip	green	-	-
Internal cross connection (removable)		-	-
Coloured partition	red	DFU/07/R (cod. DU07R)	DFU/07/R (cod. DU07R)
Cross connection barrier	red	DFM/500 (cod. DF500)	DFM/500 (cod. DF500)
Test plug		-	-
Modular test plug		SDH/7 (cod. DH007)	SDH/7 (cod. DH007)
End section for modular test plug		SH7/PT (cod. DH701)	SH7/PT (cod. DH701)
Numbering strip		CNU/8/51 (cod. NU0851S)	CNU/8/51 (cod. NU0851S)
Screwdriver for activation of the spring		CCH/2,5-4 (cod. CCH02)	CCH/2,5-4 (cod. CCH02)
Marking tag		CNU/8/51 (cod. NU0851S)	CNU/8/51 (cod. NU0851S)
		-	-
		-	-
End bracket	Snap-fit TH35 and G32	BTU (cod. BT005)	BTU (cod. BT005)
	Snap-fit TH35	BTO (cod. BT007)	BTO (cod. BT007)
	Screw TH35	BT/3 (cod. BT003)	BT/3 (cod. BT003)



INERIS 16 ATEX 9002 U
I M2 Ex e I Mb
II 2 G Ex e IIC Gb

IECEX INE 16.0032U
Ex e I Mb
Ex e IIC Gb

(1) See chapter accessories for more details

GREY VERSION	CODE	HD100GR
	TYPE	HMD.2/GR
BLUE VERSION	CODE	
	TYPE	

TECHNICAL CHARACTERISTICS

Function/type		two-level feed-through
Rated cross-section	(mm ²)	2.5
Connecting capacity	Flexible (mm ²)	0.2-4
	Rigid (mm ²)	0.2-4
	Max. flexible with ferrule - ferrule type (mm ²)	1.5-WP15/14
Electrical characteristics According to European standard IEC EN 60947-7-1	Max AC/DC Voltage (V)	630
	Max current with rated cross-section (A)	24
	Section (Caliber)	A3
Electrical characteristics According to UL	Max AC/DC Voltage (V)	600
	Max current with rated cross-section (A)	20
	Section Min - Max (AWG)	24-12
Electrical characteristics According to ATEX directive and IEC ex standard	Max AC/DC voltage (V)	400
	Max current with rated cross-section (A)	24
	Operating temperature (°C)	-40 +80
Rated impulse withstand voltage/pollution degree		8 KV / 3
Insulation stripping length	(mm)	10
Length	(mm)	91
Width	(mm)	5.2
Height mounted on TH35/7.5	(mm)	49
Height mounted on TH35/15	(mm)	56
Insulation material temperature index (EN 60216-1)	(°C)	130
Plastic material		polyamide UL94V-0

APPROVALS



ACCESSORIES		
End section	Grey	HMD/PT/GR (cod. HD101GR)
	Blue	-
	Thickness (mm)	1.5
Cross connection	PTC version (1)	PH/2.5-4 (cod. PH100)
	PTP version (1)	PHD/2 (cod. PHD02)
	Rated current (A)	24
Cross-connection identification strip	green	-
Internal cross connection (removable)		PHD/2 (cod. PHD02)
Coloured partition	red	DFH/4/R (cod. DH04R)
Cross connection barrier	red	
Test plug		-
Modular test plug		-
End section for modular test plug		-
Numbering strip		CNU/8/51 (cod. NU0851S)
Screwdriver for activation of the spring		CCH/2.5-4 (cod. CCH02)
Marking tag		CNU/8/51 (cod. NU0851S)(only lower level)
		-
End bracket	Snap-fit TH35 and G32	BTU (cod. BT005)
	Snap-fit TH35	BT0 (cod. BT007)
	Screw TH35	BT/3 (cod. BT003)

- versions made ready for housing electronic components



(1) See chapter accessories for more details

GREY VERSION	CODE TYPE	HD130GR	HD440GR	HD441GR
		HMD.1/X/GR	HMD.2N/X/GR	HMD.2N/X1/GR
BLUE VERSION	CODE TYPE			

TECHNICAL CHARACTERISTICS

Function/type		HD130GR	HD440GR	HD441GR
Rated cross-section	(mm ²)	1.5	2.5	2.5
Connecting capacity	Flexible	0.2-2.5	0.2-2.5	0.2-2.5
	Rigid	0.2-2.5	0.2-2.5	0.2-2.5
	Max. flexible with ferrule - ferrule type	1.5-WP15/14	1.5-WP15/14	1.5-WP15/14
Electrical characteristics According to European standard IEC EN 60947-7-1	Max AC/DC Voltage	500	630	630
	Max current with rated cross-section	16	24	24
	Section	B2	B2	B2
Electrical characteristics According to UL	Max AC/DC Voltage	600	-	-
	Max current with rated cross-section	15	-	-
	Section Min - Max	26-14	-	-
Electrical characteristics According to ATEX directive and IEC ex standard	Max AC/DC voltage	-	-	-
	Max current with rated cross-section	-	-	-
	Operating temperature	°C	-	-
Rated impulse withstand voltage/pollution degree		6 kV / 3	6 kV / 3	8 kV / 3
Insulation stripping length	(mm)	10	10	10
Length	(mm)	73	73	73
Width	(mm)	4.2	5.2	5.2
Height mounted on TH35/7.5	(mm)	59	59	59
Height mounted on TH35/15	(mm)	67	67	67
Insulation material temperature index (EN 60216-1)	(°C)	130	130	130
Plastic material		polyamide UL94V-0	polyamide UL94V-0	polyamide UL94V-0

APPROVALS

ACCESSORIES		HD130GR	HD440GR	HD441GR
End section	Grey	HMD.1/PT/GR (cod. HD201GR)	HMD.1/PT/GR (cod. HD201GR)	HMD.1/PT/GR (cod. HD201GR)
	Blue	-	-	-
	Thickness	(mm)	1.5	1.5
Cross connection	PTC version (1)	PTC/1/... (cod. PTC01...)	PTC/03/... (cod. PTC03...)	PTC/03/... (cod. PTC03...)
	PTP version (1)	-	-	-
	Rated current	(A)	17.5	24
Cross-connection identification strip	green	PTC/SP (cod. PTC0990)	-	-
Internal cross connection (removable)		-	-	-
Coloured partition	red	DFU/07/R (cod. DU07R)	DFU/07/R (cod. DU07R)	DFU/07/R (cod. DU07R)
Cross connection barrier	red	DFM/500 (cod. DF500)	DFM/500 (cod. DF500)	DFM/500 (cod. DF500)
Test plug		-	-	-
Modular test plug		SDH/4 (cod. DH004)	SDH/7 (cod. DH007)	SDH/7 (cod. DH007)
End section for modular test plug		SH4/PT (cod. DH401)	SH7/PT (cod. DH701)	SH7/PT (cod. DH701)
Numbering strip		SHZ/1 (cod. SH004)	CNU/8/51 (cod. NU0851S)	CNU/8/51 (cod. NU0851S)
Screwdriver for activation of the spring		CCH/2.5-4 (cod. CCH02)	CCH/2.5-4 (cod. CCH02)	CCH/2.5-4 (cod. CCH02)
Marking tag		SHZ/1 (cod. SH004)	CNU/8/51 (cod. NU0851S)	CNU/8/51 (cod. NU0851S)
		-	-	-
End bracket	Snap-fit TH35 and G32	BTU (cod. BT005)	BTU (cod. BT005)	BTU (cod. BT005)
	Snap-fit TH35	BTO (cod. BT007)	BTO (cod. BT007)	BTO (cod. BT007)
	Screw TH35	BT/3 (cod. BT003)	BT/3 (cod. BT003)	BT/3 (cod. BT003)

- Versions made ready for housing electronic components and modular test plug



(1) See chapter accessories for more details

GREY VERSION	CODE	HD420GR	HD430GR
BLUE VERSION	TYPE	HMD.2N/DD/GR	HMD.2/3DC/GR

TECHNICAL CHARACTERISTICS

Function/type		version equipped with two 1N4007 diodes in feed-through configuration for each level	version equipped with three 1N4007 diodes and shared cathode
Rated cross-section	(mm ²)	2.5	2.5
Connecting capacity	Flexible	0.2-2.5	0.2-2.5
	Rigid	0.2-2.5	0.2-2.5
	Max. flexible with ferrule - ferrule type	1.5-WP15/14	1.5-WP15/14
Electrical characteristics According to European standard IEC EN 60947-7-1	Max AC/DC Voltage	[V] 630	630
	Max current with rated cross-section	[A] 24	24
	Section	Caliber B2	B2
Electrical characteristics According to UL	Max AC/DC Voltage	[V] -	-
	Max current with rated cross-section	[A] -	-
	Section Min - Max	[AWG] -	-
Electrical characteristics According to ATEX directive and IEC ex standard	Max AC/DC voltage	[V] -	-
	Max current with rated cross-section	[A] -	-
	Operating temperature	[°C] -	-
Rated impulse withstand voltage/pollution degree		6 KV / 3	6 KV / 3
Insulation stripping length	(mm)	10	10
Length	(mm)	73	73
Width	(mm)	5.2	5.2
Height mounted on TH35/7.5	(mm)	59	59
Height mounted on TH35/15	(mm)	67	67
Insulation material temperature index (EN 60216-1)	[°C]	130	130
Plastic material		polyamide UL94V-0	polyamide UL94V-0



APPROVALS

ACCESSORIES

End section	Grey	HMD.1/PT/GR (cod. HD201GR)	HMD.1/PT/GR (cod. HD201GR)
	Blue	-	-
	Thickness	(mm) 1.5	1.5
Cross connection	PTC version (1)	PTC/03/... (cod. PTC03...)	PTC/03/... (cod. PTC03...)
	PTP version (1)	-	-
	Rated current	[A] 24	24
Cross-connection identification strip	green	-	-
Internal cross connection (removable)		-	-
Coloured partition	red	DFU/07/R (cod. DU07R)	DFU/07/R (cod. DU07R)
Cross connection barrier	red	DFM/500 (cod. DF500)	DFM/500 (cod. DF500)
Test plug		-	-
Modular test plug		SDH/7 (cod. DH007)	SDH/7 (cod. DH007)
End section for modular test plug		SH7/PT (cod. DH701)	SH7/PT (cod. DH701)
Numbering strip		CNU/8/51 (cod. NU0851S)	CNU/8/51 (cod. NU0851S)
Screwdriver for activation of the spring		CCH/2.5-4 (cod. CCH02)	CCH/2.5-4 (cod. CCH02)
Marking tag		CNU/8/51 (cod. NU0851S)	CNU/8/51 (cod. NU0851S)
		-	-
		-	-
End bracket	Snap-fit TH35 and G32	BTU (cod. BT005)	BTU (cod. BT005)
	Snap-fit TH35	BTO (cod. BT007)	BTO (cod. BT007)
	Screw TH35	BT/3 (cod. BT003)	BT/3 (cod. BT003)



Ex INERIS 16 ATEX 9002 U
I M2 Ex e I Mb
II 2 G Ex e IIC Gb

IECEX INE 16.0032U
Ex e I Mb
Ex e IIC Gb

(1) See chapter accessories for more details

GREY VERSION	CODE TYPE	HL200GR	HL210GR	HL500GR
		HLD.2/GR	HLD.2/CI/GR	HDE.2/GR
BLUE VERSION	CODE TYPE	HD510		
		HLD.2 (EX)I		

TECHNICAL CHARACTERISTICS

Function/type		3 levels	3 levels with internal connection	2 levels + earth
Rated cross-section	(mm ²)	2,5	2,5	2,5
Connecting capacity	Flexible (mm ²)	0.2-2.5	0.2-2.5	0.2-2.5
	Rigid (mm ²)	0.2-2.5	0.2-2.5	0.2-2.5
	Max. flexible with ferrule - ferrule type (mm ²)	1.5-WP15/14	1.5-WP15/14	1.5-WP15/14
Electrical characteristics According to European standard IEC EN 60947-7-1	Max AC/DC Voltage (V)	500	500	500
	Max current with rated cross-section (A)	24	24	24
	Section (Caliber)	B2	B2	B2
Electrical characteristics According to UL	Max AC/DC Voltage (V)	-	-	-
	Max current with rated cross-section (A)	-	-	-
	Section Min - Max (AWG)	-	-	-
Electrical characteristics According to ATEX directive and IEC ex standard	Max AC/DC voltage (V)	400	400	400
	Max current with rated cross-section (A)	24	24	24
	Operating temperature (°C)	-40 +80	-40 +80	-40 +80
Rated impulse withstand voltage/pollution degree		8 KV / 3	8 KV / 3	8 KV / 3
Insulation stripping length (mm)		10	10	10
Length (mm)		95	95	95
Width (mm)		5.2	5.2	5.2
Height mounted on TH35/7.5 (mm)		75	75	75
Height mounted on TH35/15 (mm)		83	83	83
Insulation material temperature index (EN 60216-1) (°C)		130	130	130
Plastic material		polyamide UL94V-0	polyamide UL94V-0	polyamide UL94V-0

APPROVALS

ACCESSORIES

End section	Grey	HLD.2/PT/GR (cod. HL201GR)	HLD.2/PT/GR (cod. HL201GR)	HLD.2/PT/GR (cod. HL201GR)
	Blue	-	-	-
	Thickness (mm)	1,5	1,5	1,5
Cross connection	PTC version (1)	PTC/03/... (cod. PTC03...)	PTC/03/... (cod. PTC03...)	PTC/03/... (cod. PTC03...)
	PTP version (1)	PTP/03/... (cod. PTP03...)	PTP/03/... (cod. PTP03...)	PTP/03/... (cod. PTP03...)
	Rated current (A)	24	24	24
Cross-connection identification strip	green	-	-	-
Internal cross connection (removable)		-	-	-
Coloured partition	red	-	-	-
Cross connection barrier	red	DFM/500 (cod. DF500)	DFM/500 (cod. DF500)	DFM/500 (cod. DF500)
Test plug		-	-	-
Modular test plug		-	-	-
End section for modular test plug		-	-	-
Numbering strip		CNU/8/51 (cod. NU0851S)	CNU/8/51 (cod. NU0851S)	CNU/8/51 (cod. NU0851S)
Screwdriver for activation of the spring		CCH/2,5-4 (cod. CCH02)	CCH/2,5-4 (cod. CCH02)	CCH/2,5-4 (cod. CCH02)
Marking tag		CNU/8/51 (cod. NU0851S)	CNU/8/51 (cod. NU0851S)	CNU/8/51 (cod. NU0851S)
		-	-	-
End bracket	Snap-fit TH35 and G32	BTU (cod. BT005)	BTU (cod. BT005)	BTU (cod. BT005)
	Snap-fit TH35	BTO (cod. BT007)	BTO (cod. BT007)	BTO (cod. BT007)
	Screw TH35	BT/3 (cod. BT003)	BT/3 (cod. BT003)	BT/3 (cod. BT003)

SPRING CLAMP



INERIS 16 ATEX 9002 U
I M2 Ex e I Mb
II 2 G Ex e IIC Gb

IECEx INE 16.0032U
Ex e I Mb
Ex e IIC Gb

(1) See chapter accessories for more details

YELLOW/GREEN VERSION

CODE
TYPE

HLT500

HTTE.2

TECHNICAL CHARACTERISTICS

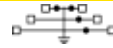

Function/type			3 levels + earth
Rated cross-section		(mm ²)	2.5
Connecting capacity	Flexible	(mm ²)	0.2-2.5
	Rigid	(mm ²)	0.2-2.5
	Max. flexible with ferrule - ferrule type	(mm ²)	1.5-WP15/14
Electrical characteristics According to European standard IEC EN 60947-7-2	Max AC/DC Voltage	(V)	-
	Max current with rated cross-section	(A)	-
	Section	Caliber	B2
Electrical characteristics According to UL	Max AC/DC Voltage	(V)	-
	Max current with rated cross-section	(A)	-
	Section Min - Max	(AWG)	-
Electrical characteristics According to ATEX directive and IEC ex standard	Max AC/DC voltage	(V)	400
	Max current with rated cross-section	(A)	24
	Operating temperature	(°C)	-40 +80
Rated impulse withstand voltage/pollution degree			8 KV / 3
Insulation stripping length		(mm)	10
Length		(mm)	95
Width		(mm)	5.2
Height mounted on TH35/7.5		(mm)	75
Height mounted on TH35/15		(mm)	83
Insulation material temperature index (EN 60216-1)		(°C)	130
Plastic material			polyamide UL94V-0

APPROVALS

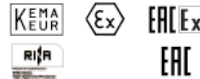

ACCESSORIES

End section	Grey		HLD.2/PT/GR (cod. HL201GR)
	Blue		-
	Thickness	(mm)	1.5
Cross connection	PTC version (1)		PTC/03/... (cod. PTC03...)
	PTP version (1)		PTP/03/... (cod. PTP03...)
	Rated current	(A)	24
Cross-connection identification strip	green		-
Internal cross connection (removable)			-
Coloured partition	red		-
Cross connection barrier	red		DFM/500 (cod. DF500)
Test plug			-
Modular test plug			-
End section for modular test plug			-
Numbering strip			CNU/8/51 (cod. NU0851S)
Screwdriver for activation of the spring			CCH/2.5-4 (cod. CCH02)
Marking tag			CNU/8/51 (cod. NU0851S)
			-
End bracket	Snap-fit TH35 and G32		BTU (cod. BT005)
	Snap-fit TH35		BTO (cod. BT007)
	Screw TH35		BT/3 (cod. BT003)

- disconnect by lever and by slide link
- for test and measurement circuits



(1) See chapter accessories for more details

GREY VERSION		CODE TYPE	HS200GR HMS.2/GR	HB100GR HSCB.4/GR	HB200GR HSCB.6/GR
TECHNICAL CHARACTERISTICS					
Function/type			disconnect by lever	disconnect by slide link	disconnect by slide link
Rated cross-section		(mm ²)	2.5	4	6
Connecting capacity	Flexible	(mm ²)	0.2-4	0.2-6	0.2-10
	Rigid	(mm ²)	0.2-4	0.2-6	0.2-10
	Max. flexible with ferrule - ferrule type	(mm ²)	2.5-WP25/14	4-WP40/16	6-WP60/20
Electrical characteristics According to European standard IEC EN 60947-7-1	Max AC/DC Voltage	(V)	400	800	800
	Max current with rated cross-section	(A)	16	32	41
	Section	Caliber	A3	A4	A5
Electrical characteristics According to UL	Max AC/DC Voltage	(V)	600	600	600
	Max current with rated cross-section	(A)	24	30	35
	Section Min - Max	(AWG)	24-12	28-10	24-8
Rated impulse withstand voltage/pollution degree			6 KV / 3	6 KV / 3	6 KV / 3
Insulation stripping length		(mm)	10	12	12
Length		(mm)	66	86	97
Width		(mm)	5.2	6.2	8.2
Height mounted on TH35/7.5		(mm)	37	45	48
Height mounted on TH35/15		(mm)	45	53	56
Insulation material temperature index (EN 60216-1)		(°C)	130	130	130
Plastic material			polyamide UL94V-0	polyamide UL94V-0	polyamide UL94V-0
APPROVALS					
ACCESSORIES					
End section	Grey		HMT.2/1+2/PT/GR (cod. HM511GR)	HSCB.4/PT/GR (cod. HB101GR)	HSCB.6/PT/GR (cod. HB201GR)
	Blue		-	-	-
	Thickness	(mm)	1.5	1.5	1.5
Cross connection	PTC version (1)		PTC/03/... (cod. PTC03...)	PTC/05/... (cod. PTC05...)	PTC/8/... (cod. PTC08...)
	PTP version (1)		PTP/03/... (cod. PTP03...)	PTP/05/... (cod. PTP05...)	-
	Rated current	(A)	24	32	41
Cross-connection identification strip	green		-	PTC/SP (cod. PTC0990)	PTC/SP (cod. PTC0990)
Coloured partition	red		DFH/2/R (cod. DH02R)	DFH/4/R (cod. DH04R)	-
Cross connection barrier	red		-	-	DFM/500 (cod. DF500)
Test plug			SDD/1 (cod. DD001)	-	SDD/1 (cod. DD001)
Modular test plug			SDH/5 (cod. DH005)	SDH/6 (cod. DH006)	-
End section for modular test plug			SH5/PT (cod. DH501)	SH6/PT (cod. DH601)	-
Numbering strip			CNU/8/51 (cod. NU0851)	-	-
Screwdriver for activation of the spring			CCH/2.5-4 (cod. CCH02)	CCH/2.5-4 (cod. CCH02)	CCH/6 (cod. CCH06)
Screw and sleeve for short-circuit plates (with socket)			-	HSCB/4/CPM (cod. HB405)	HSCB/6/CPM (cod. HB205)
Short-circuit plate	2 poles		-	HSCB/4/PO/2 (cod. HB403)	HSCB/6/PO/2 (cod. HB203)
	4 poles		-	HSCB/4/PO/4 (cod. HB404)	HSCB/6/PO/4 (cod. HB204)
Marking tag			-	CNU/8/51 (cod. NU0851S)	CNU/8/51 (cod. NU0851S)
			-	-	-
End bracket	Snap-fit TH35 and G32		BTU (cod. BT005)	BTU (cod. BT005)	BTU (cod. BT005)
	Snap-fit TH35		BTO (cod. BT007)	BTO (cod. BT007)	BTO (cod. BT007)
	Screw TH35		BT/3 (cod. BT003)	BT/3 (cod. BT003)	BT/3 (cod. BT003)

- for “blade” fuse according to DIN 72581/3F – ISO 8820 and for Ø 5 x 20 mm fuses (all supplied separately)
- modular with component-holder cartridge CPF05, this one should be provided empty or already composed with electronic circuits (for more details see accessories chapter)



(1) See chapter accessories for more details

GREY VERSION		CODE TYPE	HF300GR
			HMFA.2/GR
TECHNICAL CHARACTERISTICS			
Function/type			for blade fuse and component-holder cartridge
Rated cross-section		(mm ²)	2.5
Connecting capacity		Flexible	0.2-4
		Rigid	0.2-4
		Max. flexible with ferrule - ferrule type	2.5-WP25/14
Electrical characteristics According to European standard IEC EN 60947-7-1		Max AC/DC Voltage	(V) 400
		Max current with rated cross-section	(A) 6.3
		Section	Caliber A3
Electrical characteristics According to UL		Max AC/DC Voltage	(V) -
		Max current with rated cross-section	(A) -
		Section Min-Max	(AWG) -
Rated impulse withstand voltage/pollution degree			4 KV / 3
Insulation stripping length		(mm)	10
Length		(mm)	66
Width		(mm)	5.2
Height mounted on TH35/7,5		(mm)	41
Height mounted on TH35/15		(mm)	49
Insulation material temperature index (EN 60216-1)		(°C)	130
Plastic material			polyamide UL94V-0
APPROVALS			
ACCESSORIES			
End section		Grey	HMT.2/1+2/PT/GR (cod. HM511GR)
		Blue	-
		Thickness	(mm) 1.5
Cross connection		PTC version (1)	PTC/03/... (cod. PTC03...)
		PTP version (1)	PTP/03/... (cod. PTP03...)
		Rated current	(A) 24
Cross connection identification strip		(100mm)	-
Coloured partition		Red	DFH/2/R (cod. DH02R)
Cross connection barrier		Red	
Test plug			SDD/1 (cod. DD001)
Modular test plug			SDH/5 (cod. DH005)
End section for modular test plug			SH5/PT (cod. DH501)
Screwdriver for activation of the spring			CCH/2.5-4 (cod. CCH02)
Component-holder cartridge		(1)	CPF/5 (CPF05)
Blade-type fuses according to DIN 72581/3F ISO 8820 max voltage 32 V In = 2 A, 5A, 7.5A, 15A			F32/... (cod. FN032...)
Numbering strip			CNU/8/51 (cod. NU0851S)
Marking tag			CNU/8/51 (cod. NU0851S)
End bracket		Snap-fit TH35	BTU (cod. BT005)
		Snap-fit TH35	BTO (cod. BT007)
		Snap TH35	BT/3 (cod. BT003)

MAX. DISSIPATED POWER IN CONF. WITH IEC 60947-7-3				
Terminal block	MPFA.4 + CPF/5	DSFA.4 + CPF/5	HMFA.2 + CPF/5	
Voltage (V)	250	250	250	
Current (A)	6.3	6.3	6.3	
Protection against overload and short circuit	Single configuration (PV) - (W)	1.6	1.6	1.6
	Composite configuration (PV) - (W)	1.6	1.6	1.6
Only protection against short circuit	Single configuration (PVK) - (W)	4	4	4
	Composite configuration (PVK) - (W)	1.6	1.6	1.6

- for $\varnothing 5 \times 20$ mm or $\varnothing 6.3 \times 32$ mm fuses (supplied separately), with possible warning of any broken fuse through LED microcircuit (CIL/...) or [only HFR.4/GR] neon light (LSN)
- available in grey (RAL 7042)
- can be coupled with all HMM.4/... terminal blocks



[1] See chapter accessories for more details

GREY VERSION		CODE TYPE	HF310GR HFR.4/M/GR	HF210GR HFR.4/GR
TECHNICAL CHARACTERISTICS				
Function/type			for $\varnothing 5 \times 20$ mm fuse	for $\varnothing 6.3 \times 32$ mm fuse
Rated cross-section		[mm ²]	4	4
Connecting capacity	Flexible	[mm ²]	0.2-6	0.2-6
	Rigid	[mm ²]	0.2-6	0.2-6
	Max. flexible with ferrule - ferrule type	[mm ²]	4-WP40/16	4-WP40/16
Electrical characteristics According to European standard IEC EN 60947-7-1	Max AC/DC Voltage	[V]	500	500
	Max current with rated cross-section	[A]	6.3 A (10 A with CO/5)	10
	Section	Caliber	A4	A4
Electrical characteristics According to UL	Max AC/DC Voltage	[V]	600	600
	Max current with rated cross-section	[A]	10	15
	Section Min-Max	[AWG]	28 - 10	28 - 10
Rated impulse withstand voltage/pollution degree			4 KV / 3	4 KV / 3
Insulation stripping length		[mm]	12	12
Length		[mm]	78	78
Width		[mm]	6.2	8.2
Height mounted on TH35/7,5		[mm]	70	70
Height mounted on TH35/15		[mm]	78	78
Insulation material temperature index (EN 60216-1)		[°C]	130	130
Plastic material			polyamide UL94V-0	polyamide UL94V-0
APPROVALS				
ACCESSORIES				
End section	Grey		HFR.4/PT/GR [cod. HF211GR]	-
	Blue		-	-
	Thickness	[mm]	1.5	-
Cross connection	PTC version [1]		PTC/5/... [cod. PTC05...]	PTC/51/... [cod. PTC51...]
	PTP version [1]		-	-
	Rated current	[A]	32	32
Cross connection identification strip	{100mm}		PTC/SP [cod. PTC0990]	PTC/SP [cod. PTC0990]
Coloured partition	Red		DFH/4/R [cod. DH04R]	DFH/4/R [cod. DH04R]
Cross connection barrier	Red		-	-
Test plug			SDD/1 [cod. DD001]	SDD/1 [cod. DD001]
Miniature fuse	$\varnothing 5 \times 20$ mm		F5/... [cod. FN...]	-
Conductive element	$\varnothing 5 \times 20$ mm		CO/5 [cod. VL103]	-
Neon lamp	$\varnothing 6 \times 26$ mm		-	LSN [cod. FL202]
Warning circuit			CIL/HFR/M/12-48 [cod. HF518M]	CIL/HFR/12-48 [cod. HF518]
Warning circuit			CIL/HFR/M/115-230 [cod. HF510M]	CIL/HFR/115-230 [cod. HF510]
Terminal block with 12-48 V non-polarized LED circuit			HFR.4/M/GR/C12-48 [cod. HF918MGR]	HFR.4/GR/C115-230 [cod. HF910GR]
Terminal block with 115-230 V non-polarized LED circuit			HFR.4/M/GR/C115-230 [cod. HF910MGR]	HFR.4/M/GR/C115-230 [cod. HF910MGR]
Numbering strip			CNU/8/61 [cod. NU0861S]	-
Screwdriver for activation of the spring			CCH/2.5-4 [cod. CCH02]	CCH/2.5-4 [cod. CCH02]
Marking tag			CNU/8/51 [cod. NU0851S]	CNU/8/51 [cod. NU0851S]
			CNU/8/51 [cod. NU1051S]	CNU/8/51 [cod. NU1051S]
			-	-
End bracket	Snap-fit TH35		BTU [cod. BT005]	BTU [cod. BT005]
	Snap-fit TH35		BTO [cod. BT007]	BTO [cod. BT007]
	Snap TH35		BT/3 [cod. BT003]	BT/3 [cod. BT003]

- for female connectors pitch 5.08 mm – on two levels



(1) See chapter accessories for more details

GREY VERSION	CODE	HC200GR
	TYPE	HCD.1/GR
BLUE VERSION	CODE	HC210
	TYPE	HCD.1 (EX)I

TECHNICAL CHARACTERISTICS

Function/type	2 level feed-through with 2 screw connections and 2 pins for connectors	
Rated cross-section	(mm ²)	1.5
Connecting capacity	Flexible	(mm ²) 0.2-2.5
	Rigid	(mm ²) 0.2-2.5
	Max. flexible with ferrule - ferrule type	(mm ²) 1.5-WP15/14
Electrical characteristics According to European standard IEC EN 60947-7-1	Max AC/DC Voltage	(V) 320
	Max current with rated cross-section	(A) 12
	Section	Caliber B2
Electrical characteristics According to UL	Max AC/DC Voltage	(V) 300
	Max current with rated cross-section	(A) 12
	Section Min-Max	(AWG) 26 - 14
Rated impulse withstand voltage/pollution degree		6 KV / 3
Insulation stripping length	(mm)	10
Width	(mm)	5.08
Length	(mm)	72
Height mounted on TH35/7,5	(mm)	59
Height mounted on TH35/15	(mm)	67
Insulation material temperature index (EN 60216-1)	(°C)	130
Plastic material		polyamide UL94V-0

APPROVALS



ACCESSORIES

End section	Grey	HCD.1/PT/GR (cod. HC201GR)
	Blue	HCD.1/PT(Ex)I (cod. HC211)
Cross connection	Thickness (mm)	3
	PTC version (1)	PTC/2/... (cod. PTC02...)
	PTP version (1)	-
	Rated current (A)	24
Cross connection identification strip	{100mm}	-
Coloured partition	Red	DFU/7/R (cod. DU07R)
Cross connection barrier	Red	DFM/500 (cod. DF500)
Test plug		-
Modular test plug		-
End section for modular test plug		-
Protection cover for 10-pole shanks		VPC/VT (cod. VP102)
Numbering strip		CNU/8/51 (cod. NU0851S)
Screwdriver for activation of the spring		CCH/2.5-4 (cod. CCH02)
Marking tag		CNU/8/51 (cod. NU0851S)
Marking tag		CNU/10/51 (cod. NU1051S)
End bracket	Snap-fit TH35	BTO (cod. BT007)
End bracket	Screw TH35	BT/3 (cod. BT003)



Detail of PTC jumper with DFM/500 barriers, CNU/8/51 numbering strips and VPC/VT lug protection covers



Detail with 5.08 mm female connectors inserted on the two levels and the lug protection covers raised

Female connectors, 90°-5.08 mm pitch and with a number of poles from 2 to 16, are available. The connector can be easily inserted until it reaches its blocking position, guaranteeing optimum connection onto the male contact. In this position the connector is hooked onto the insulating body with the holding tooth with which it is fitted.

VPC/F02	2 poles	Cat. No.	VP902
VPC/F03	3 poles	Cat. No.	VP903
VPC/F04	4 poles	Cat. No.	VP904
VPC/F05	5 poles	Cat. No.	VP905
VPC/F06	6 poles	Cat. No.	VP906
VPC/F07	7 poles	Cat. No.	VP907
VPC/F08	8 poles	Cat. No.	VP908
VPC/F09	9 poles	Cat. No.	VP909
VPC/F10	10 poles	Cat. No.	VP910
VPC/F11	11 poles	Cat. No.	VP911
VPC/F12	12 poles	Cat. No.	VP912
VPC/F13	13 poles	Cat. No.	VP913
VPC/F14	14 poles	Cat. No.	VP914
VPC/F15	15 poles	Cat. No.	VP915
VPC/F16	16 poles	Cat. No.	VP916

- spring system with connector plug



(1) See chapter accessories for more details
(2) dimensions with inserted connector

GREY VERSION	CODE TYPE	HVP300GR HVPC.2/GR	HVP900GR CHP.2/GR	HVP910GR CHP.2D/GR
BLUE VERSION	CODE TYPE	HVP305 HVPC.2 (EX)I	HVP905 CHP.2 (EX)I	HVP915 CHP.2D (EX)I

TECHNICAL CHARACTERISTICS

Function/type		feed trough for connectors	female connector for one conductor	female connector for two conductors
Rated cross-section	(mm²)	2.5	2.5	2.5
Connecting capacity	Flexible (mm²)	0.2-4	0.2-4	0.2-4
	Rigid (mm²)	0.2-4	0.2-4	0.2-4
	Max. flexible with ferrule - ferrule type (mm²)	2.5-WP25/14	2.5-WP25/14	2.5-WP25/14
Electrical characteristics According to European standard IEC EN 60947-7-1	Max AC/DC Voltage (V)	800	500	500
	Max current with rated cross-section (A)	24	24	24
	Section Caliber	A3	A3	A3
Electrical characteristics According to UL	Max AC/DC Voltage (V)	-	-	-
	Max current with rated cross-section (A)	-	-	-
	Section Min-Max (AWG)	-	-	-
Electrical characteristics According to ATEX directive and IEC ex standard	Max AC/DC Voltage (V)	-	-	-
	Max current with rated cross-section (A)	-	-	-
	Operating temperature (°C)	-	-	-
Rated impulse withstand voltage/pollution degree		8 KV / 3	8 KV / 3	8 KV / 3
Insulation stripping length (mm)		10	10	10
Length (mm)		50	58 (2)	58 (2)
Width (mm)		5.2	5.2	5.2
Height mounted on TH35/7,5 (mm)		41	67 (2)	67 (2)
Height mounted on TH35/15 (mm)		49	75 (2)	75 (2)
Insulation material temperature index (EN 60216-1) (°C)		130	130	130
Plastic material		polyamide UL94V-0	polyamide UL94V-0	polyamide UL94V-0

APPROVALS



ACCESSORIES				
End section	Grey	HVPC.2/PT/GR (cod. HVP301GR)	CHP.2/PT/GR (cod. HVP901GR)	CHP.2D/PT/GR (cod. HVP911GR)
	Blue	-	-	-
	Thickness (mm)	1.5	1.5	1.5
Cross connection	PTC version (1)	PTC/03/... (cod. PTC03...)	PTC/03/... (cod. PTC03...)	PTC/03/... (cod. PTC03...)
	PTP version (1)	PTP/03/... (cod. PTC03...)	PTP/03/... (cod. PTC03...)	PTP/03/... (cod. PTC03...)
	Rated current (A)	24	24	24
Cross connection identification strip	(100mm) Green	PTC/SP (cod. PTC0990)	PTC/SP (cod. PTC0990)	PTC/SP (cod. PTC0990)
Coloured partition	Red	DFH/1/R (cod. DH01R)	DFH/1/R (cod. DH01R)	DFH/1/R (cod. DH01R)
Cross connection barrier	Red	-	-	-
Test plug		SDD/1 (cod. DD001)	SDD/1 (cod. DD001)	SDD/1 (cod. DD001)
Modular test plug		SDH/5 (cod. DH005)	SDH/5 (cod. DH005)	SDH/5 (cod. DH005)
End section for modular test plug		SH5/PT (cod. DH501)	SH5/PT (cod. DH501)	SH5/PT (cod. DH501)
Screwdriver for activation of the spring		CCH/2.5-4 (cod. CCH02)	CCH/2.5-4 (cod. CCH02)	CCH/2.5-4 (cod. CCH02)
Numbering strip		CNU/8/51 (cod. NU0851S)	CNU/8/51 (cod. NU0851S)	CNU/8/51 (cod. NU0851S)
Marking tag		CNU/8/51 (cod. NU0851S)	CNU/8/51 (cod. NU0851S)	CNU/8/51 (cod. NU0851S)
Marking tag		CNU/10/51 (cod. NU1051S)	CNU/10/51 (cod. NU1051S)	CNU/10/51 (cod. NU1051S)
End bracket	Snap-fit TH35 and G32	BTU (cod. BT005)	-	-
End bracket	Snap-fit TH35	BTO (cod. BT007)	-	-
End bracket	Screw TH35	BT/3 (cod. BT003)	-	-

- spring system with connector plug for earth connections



(1) See chapter accessories for more details
(2) dimensions with inserted connector

YELLOW/GREEN VERSION		CODE TYPE	HVT500 HVTE.2	HVT900 CHTE.2	HVT910 CHTE.2D
TECHNICAL CHARACTERISTICS					
Function/type					
Rated cross-section		[mm ²]	2.5	2.5	2.5
Connecting capacity	Flexible	[mm ²]	0.2-4	0.2-4	0.2-4
	Rigid	[mm ²]	0.2-4	0.2-4	0.2-4
	Max. flexible with ferrule - ferrule type	[mm ²]	2.5-WP25/14	2.5-WP25/14	2.5-WP25/14
Electrical characteristics According to European standard IEC EN 60947-7-2	Max AC/DC Voltage	[V]	-	-	-
	Max current with rated cross-section	[A]	-	-	-
	Section	Caliber	A3	A3	A3
Electrical characteristics According to UL	Max AC/DC Voltage	[V]	600	600	600
	Max current with rated cross-section	[A]	-	-	-
	Section Min-Max	[AWG]	28-12	28-12	28-12
Electrical characteristics According to ATEX directive and IEC ex standard	Max AC/DC Voltage	[V]	-	-	-
	Max current with rated cross-section	[A]	-	-	-
	Operating temperature	[°C]	-	-	-
Rated impulse withstand voltage/pollution degree			8 KV / 3	8 KV / 3	8 KV / 3
Insulation stripping length		[mm]	10	10	10
Length		[mm]	50	58 (2)	58 (2)
Width		[mm]	5.2	5.2	5.2
Height mounted on TH35/7,5		[mm]	41	67 (2)	67 (2)
Height mounted on TH35/15		[mm]	49	75 (2)	75 (2)
Insulation material temperature index (EN 60216-1)		[°C]	130	130	130
Plastic material			polyamide UL94V-0	polyamide UL94V-0	polyamide UL94V-0
APPROVALS					
ACCESSORIES					
End section	Grey		HVPC.2/PT/GR (cod. HVP301GR)	CHP.2/PT/GR (cod. HVP901GR)	CHP.2D/PT/GR (cod. HVP911GR)
	Blue		-	-	-
Cross connection	Thickness	[mm]	1.5	1.5	1.5
	PTC version (1)		PTC/03/... (cod. PTC03...)	PTC/03/... (cod. PTC03...)	PTC/03/... (cod. PTC03...)
	PTP version (1)		PTP/03/... (cod. PTC03...)	PTP/03/... (cod. PTC03...)	PTP/03/... (cod. PTC03...)
Cross connection identification strip	Rated current	[A]	24	24	24
	(100mm) Green		PTC/SP (cod. PTC0990)	PTC/SP (cod. PTC0990)	PTC/SP (cod. PTC0990)
Coloured partition	Red		DFH/1/R (cod. DH01R)	DFH/1/R (cod. DH01R)	DFH/1/R (cod. DH01R)
Cross connection barrier	Red		-	-	-
Test plug			SDD/1 (cod. DD001)	SDD/1 (cod. DD001)	SDD/1 (cod. DD001)
Modular test plug			SDH/5 (cod. DH005)	SDH/5 (cod. DH005)	SDH/5 (cod. DH005)
End section for modular test plug			SH5/PT (cod. DH501)	SH5/PT (cod. DH501)	SH5/PT (cod. DH501)
Screwdriver for activation of the spring			CCH/2.5-4 (cod. CCH02)	CCH/2.5-4 (cod. CCH02)	CCH/2.5-4 (cod. CCH02)
Numbering strip			CNU/8/51 (cod. NU0851S)	CNU/8/51 (cod. NU0851S)	CNU/8/51 (cod. NU0851S)
Marking tag			CNU/8/51 (cod. NU0851S)	CNU/8/51 (cod. NU0851S)	CNU/8/51 (cod. NU0851S)
Marking tag			CNU/10/51 (cod. NU1051S)	CNU/10/51 (cod. NU1051S)	CNU/10/51 (cod. NU1051S)
End bracket	Snap-fit TH35 and G32		BTU (cod. BT005)	-	-
End bracket	Snap-fit TH35		BTO (cod. BT007)	-	-
End bracket	Screw TH35		BT/3 (cod. BT003)	-	-

- space saving
- mounting only on PR/2 TH/15

	INERIS 16 ATEX 9002 U	IECEx INE 16.0032U
	I M2 Ex e I Mb	Ex e I Mb
	II 2 G Ex E IIC Gb	Ex e IIC Gb

(1) See chapter accessories for more details

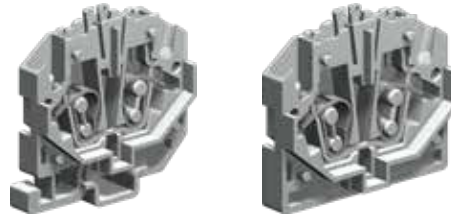

GREY VERSION	CODE TYPE	HP170GR	HPP.2/GR	HP150GR	HP.2/GR
BLUE VERSION	CODE TYPE	HI132	HPP.2 (EX)I	HI130	HP.2 (EX)I

TECHNICAL CHARACTERISTICS

Function/type		feed-through	feed-through
Rated cross-section	(mm²)	2.5	2.5
Connecting capacity	Flexible (mm²)	0.2-4	0.2-4
	Rigid (mm²)	0.2-4	0.2-4
	Max. flexible with ferrule - ferrule type (mm²)	2.5-WP25/14	2.5-WP25/14
Electrical characteristics According to European standard IEC EN 60947-7-1	Max AC/DC Voltage (V)	800	800
	Max current with rated cross-section (A)	24	24
	Section Caliber	A3	A3
Electrical characteristics According to UL	Max AC/DC Voltage (V)	600	600
	Max current with rated cross-section (A)	20 / 24	20 / 24
	Section Min-Max (AWG)	28-12	28-12
Electrical characteristics According to ATEX directive and IEC ex standard	Max AC/DC Voltage (V)	630	630
	Max current with rated cross-section (A)	24	24
	Operating temperature (°C)	-40 +80	-40 +80
Rated impulse withstand voltage/pollution degree		8 KV / 3	8 KV / 3
Insulation stripping length	(mm)	10	10
Length	(mm)	36	36
Width	(mm)	5.2	5.2
Height mounted on TH15/5,5	(mm)	36	36
Insulation material temperature index (EN 60216-1)	(°C)	130	130
Plastic material		polyamide UL94V-0	polyamide UL94V-0

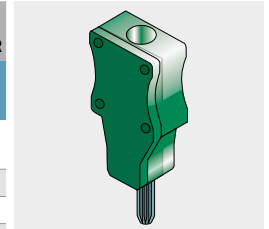

Modular test plug



In electrical panels where the spaces are particularly limited and in any case when a high wiring density is required, Cabur proposes, also for the connection with spring technology, a series of mini terminal blocks, for conductors up to 4 mm². The range comprises three versions, for panel mounting (fixing with screw or clip) and for mounting on 15 mm PR/2 guide, according to IEC 60715. The particular conformation of the insulating body of the three types of terminal blocks enables snap-in coupling of each of them, including between terminal blocks of different types, in order to ensure the maximum flexibility of use.

SUGGESTED COMPOSITION: for mounting terminal boards made up of **HPP.2/GR** terminal blocks a conformation of the terminal board of four **HP.2/GR** for every **HPP.2/GR** is recommended. If instead it is necessary to remove the terminal board thus made up from the guide, it is recommended to separate units made up of a **HPP.2/GR** and remove one at a time, with the aid of an opportune screwdriver (CCH/2,5-4), acting in the specific slots.

APPROVALS

ACCESSORIES

End section	Grey	HP/PT/GR (cod. HP101GR)	HPV/PT/GR (cod. HV111GR)
	Blue	-	-
Cross connection	Thickness (mm)	1.5	1.5
	PTC version (1)	PTC/03/... (cod. PTC03...)	PTC/03/... (cod. PTC03...)
	PTP version (1)	-	-
Cross connection identification strip	Rated current (A)	24	24
	green	PTC/SP (cod. PTC0990)	PTC/SP (cod. PTC0990)
Coloured partition	Red	DFP/2/R (cod. DFP2R)	DFP/2/R (cod. DFP2R)
Test plug		SDD/1 (cod. DD001)	SDD/1 (cod. DD001)
Modular test plug		SDH/5 (cod. DH005)	SDH/5 (cod. DH005)
End section for modular test plug		SH5/PT (cod. DH501)	SH5/PT (cod. DH501)
Screwdriver for activation of the spring		CCH/2,5-4 (cod. CCH02)	CCH/2,5-4 (cod. CCH02)
Marking tag		SHZ/2 (cod. SH001)	SHZ/2 (cod. SH001)
End bracket	Screw TH35	BT/2 (cod. BT006)	BT/2 (cod. BT006)



- panel mount by means of clips
- fixing hole Ø 3.5 mm
- panel thickness 0.6 – 1.2 mm

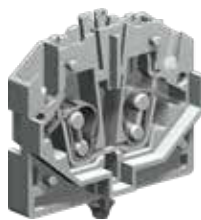

INERIS 16 ATEX 9002 U
I M2 Ex e I Mb
II 2 G Ex E IIC Gb

IECEX INE 16.0032U
Ex e I Mb
Ex e IIC Gb

(1) See chapter accessories for more details

GREY VERSION	CODE	HP160GR
	TYPE	HPC.2/GR
BLUE VERSION	CODE	HI131
	TYPE	HPC.2 (EX)I

TECHNICAL CHARACTERISTICS

Function/type		feed-through
Rated cross-section	(mm²)	2.5
Connecting capacity	Flexible (mm²)	0.2-4
	Rigid (mm²)	0.2-4
	Max. flexible with ferrule - ferrule type (mm²)	2.5-WP25/14
Electrical characteristics According to European standard IEC EN 60947-7-1	Max AC/DC Voltage (V)	800
	Max current with rated cross-section (A)	24
	Section Caliber	A3
Electrical characteristics According to UL	Max AC/DC Voltage (V)	600
	Max current with rated cross-section (A)	20 / 24
	Section Min-Max (AWG)	28-12
Electrical characteristics According to ATEX directive and IEC ex standard	Max AC/DC Voltage (V)	630
	Max current with rated cross-section (A)	24
	Operating temperature (°C)	-40 +80
Rated impulse withstand voltage/pollution degree		8 KV / 3
Insulation stripping length	(mm)	10
Length	(mm)	36
Width	(mm)	5.2
Height mounted on TH35/7,5	(mm)	31
Insulation material temperature index (EN 60216-1)	(°C)	130
Plastic material		polyamide UL94V-0



APPROVALS



ACCESSORIES

End section	Grey	HPV/PT/GR (cod. HV111GR)
	Blue	-
Cross connection	Thickness (mm)	1.5
	PTC version (1)	PTC/03/... (cod. PTC03...)
	PTP version (1)	-
Cross connection identification strip	Rated current (A)	24
	green	PTC/SP (cod. PTC0990)
Coloured partition	Red	DFP/2/R (cod. DFP2R)
Test plug		SDD/1 (cod. DD001)
Modular test plug		SDH/5 (cod. DH005)
End section for modular test plug		SH5/PT (cod. DH501)
Screwdriver for activation of the spring		CCH/2.5-4 (cod. CCH02)
Marking tag		SHZ/2 (cod. SH001)
End bracket	Screw TH35	BT/2 (cod. BT006)

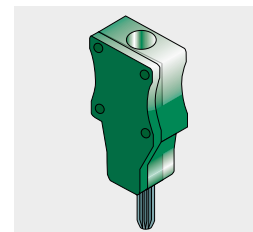

Modular test plug



In electrical panels where the spaces are particularly limited and in any case when a high wiring density is required, Cabur proposes, also for the connection with spring technology, a w of mini terminal blocks, for conductors up to 4 mm². The range comprises three versions, for panel mounting (fixing with screw or clip) and for mounting on 15 mm PR/2 guide. The particular conformation of the insulating body of the three types of terminal blocks enables snap-in coupling of each of them, including between terminal blocks of different types, in order to ensure the maximum flexibility of use.

Blank lined area for notes.

Screw-Clamp Terminal Blocks

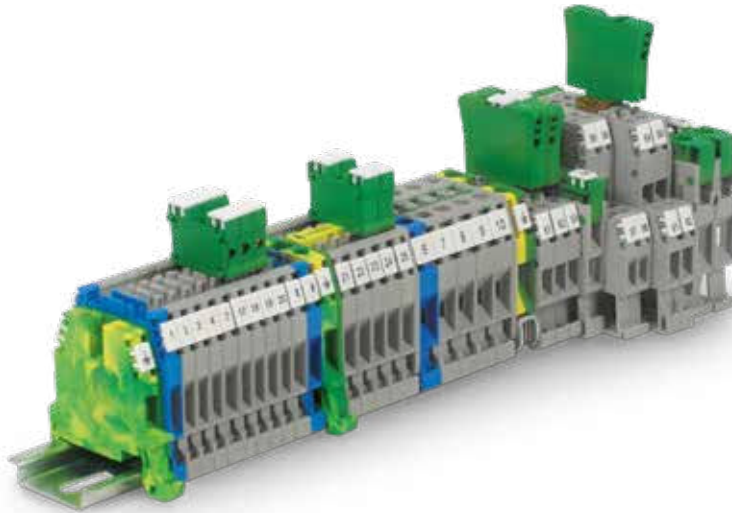

CESI 08 ATEX 061 U
I M2 Ex eb I Mb
II 2 G Ex eb IIC Gb

IECEX CES 09.0002U
Ex eb I Mb
Ex eb IIC Gb

- Reduced overall dimensions
- Mounting on PR/3 rails according IEC 60715, TH/35 type
- Nominal voltage 1000 V
- Maximum continual operating temperature 130°C

- Double possibility of inserting multi-pole PTC cross connections, with no need for additional insulating covers, thanks to the patented "Easy Bridge" (PTC) system and to the new "Easy Bridge Plus" (PTP)
- Available in grey and blue; for other available colours refer to the single versions

Easy Bridge System

The Cross connection can be supplied in "standard" size, for 2-3-5-10 poles, or in 250-mm-long bars. The "Easy Bridge" connection system guarantees the widest possibility of transversal connection, including offset.

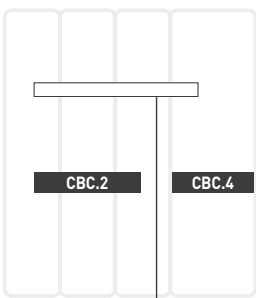
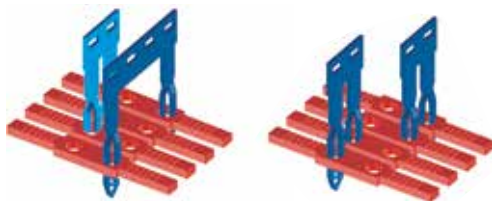

Multi-pole CBC.2 cross-connection

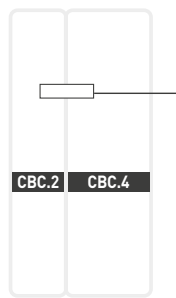

2 pole CBC.2 cross-connection

The cross connections can also be used to connect in parallel terminal blocks of the same section with the first of the following unit with a different section.

SDC
mounted



SDC/P
mounted



SDC - SDC/P
with conductors



DFM/900



DFM/800



After cutting the bar for the number of poles necessary, insert the cross connection in the special cavity of the terminal block.

At this point working with the tip of a screwdriver, push the cross connection up to the locking point. The cross connection will be completely isolated and intrinsically IPXXB protected.



After inserting the cross connection, the poles connected can be highlighted with the aid of the green insert, PTC/SP. This accessory is supplied in the standard length of 100 mm and can easily be sliced with the aid of a simple cutter.



To remove the cross connection it is sufficient to remove the PTC/SP insert, insert the tip of the screwdriver in the slot of the cross connection itself, lever it and pull it out.



CESI 08 ATEX 061 U
I M2 Ex eb I Mb
II 2 G Ex eb IIC Gb

IECEx CES 09.0002U
Ex eb I Mb
Ex eb IIC Gb

(1) See chapter accessories for more details



GREY VERSION	CODE TYPE	CBC02GR	CBC.2/GR	CBC04GR	CBC.4/GR	CBC06GR	CBC.6/GR
BLUE VERSION	CODE TYPE	CBI02	CBC.2 (EX)I	CBI04	CBC.4 (EX)I	CBI06	CBC.6 (EX)I

TECHNICAL CHARACTERISTICS

Function/type		feed-through	feed-through	feed-through
Rated cross-section	(mm ²)	2.5	4	6
Connecting capacity	Flexible (mm ²)	0,2 ÷ 4	0,2 ÷ 6	0,2 ÷ 10
	Rigid (mm ²)	0,2 ÷ 4	0,2 ÷ 6	0,2 ÷ 10
	Max.flexible with ferrule - ferrule type (mm ²)	2.5 - WP25 / 14	4 - WP40 / 16	6 - WP60 / 20
Electrical characteristics According to European standard IEC EN 60947-7-1	Max AC/DC Voltage (V)	1000	1000	1000
	Max current with rated cross-section (A)	24	32	41
	Max current with Max cross-section (A)	37	45	64
	Section Caliber	A3	A4	A5
Electrical characteristics According to UL	Max AC/DC Voltage (V)	600	600	600
	Max current with rated cross-section/Factory wiring only (A)	20 / 24	30 / 32	50
	Section Min-Max (AWG)	20-12	20-10	20-8
	Tightening torque (lb.in)	3.5	4.4	15
Electrical characteristics According to ATEX directive and IEC ex standard	Max AC/DC Voltage (V)	500	500	500
	Max current with rated cross-section (A)	24	32	41
	Operating temperature (°C)	-40 ÷ +110	-40 ÷ +110	-40 ÷ +110
Rated impulse withstand voltage/pollution degree		12 KV / 3	12 KV / 3	8 KV / 3
Insulation stripping length (mm)		9	10	10
Tightening torque nominal/max (Nm)		0,4 / 0,8	0,5 / 1,2	0,8 / 1,4
Width (mm)		5	6	8
Length (mm)		44	44	44
Height mounted on TH35/7,5 (mm)		52	52	52
Height mounted on TH35/15 (mm)		60	60	60
Insulation material temperature index (EN 60216-1) (°C)		130	130	130
Plastic material		polyamide UL94V-0	polyamide UL94V-0	polyamide UL94V-0

APPROVALS



ACCESSORIES				
End section	Grey	CBC.2-10/PT/GR (cod. CB061GR)	CBC.2-10/PT/GR (cod. CB061GR)	CBC.2-10/PT/GR (cod. CB061GR)
	Blue	CBC.2-10/PT (Ex)I (cod. CBI061)	CBC.2-10/PT (Ex)I (cod. CBI061)	CBC.2-10/PT (Ex)I (cod. CBI061)
	Thickness (mm)	1.5	1.5	1.5
Cross connection	PTC version (1)	PTC/2/... (cod. PTC02...)	PTC/4/... (cod. PTC04...)	PTC/6/... (cod. PTC06...)
	PTP version (1)	PTP/2/... (cod. PTP02...)	PTP/4/... (cod. PTP04...)	-
	Rated current / Rated current ATEX applications (A)	24 / 21	32 / 25	41 / 35
Cross connection identification strip	green	PTC/SP (cod. PTC0990)	PTC/SP (cod. PTC0990)	PTC/SP (cod. PTC0990)
Disconnectable parallel bridge		-	-	-
Multiple common bar	250 mm	-	-	-
Shunting screw and sleeve	Standard / Ex e version	-	-	-
Coloured partition	red	DFU/4/R (cod. DU04R)	DFU/4/R (cod. DU04R)	DFU/4/R (cod. DU04R)
Cross connection barrier	red	DFM/800 (cod. DF800) - DFM/900 (cod. DF900)	DFM/800 (cod. DF800) - DFM/900 (cod. DF900)	DFM/800 (cod. DF800) - DFM/900 (cod. DF900)
Test plug socket		-	-	-
Test plug		-	-	-
Polarization insert		SDC/POL (cod. DCPOL)	SDC/POL (cod. DCPOL)	-
Modular test plug		SDC/5 (cod. DC005) - SDC/5P (cod. DC05P)	SDC/6 (cod. DC006) - SDC/6P (cod. DC06P)	-
Numbering strip		CNU/8/51 (cod. NU0851S)	CNU/8/61 (cod. NU0861S)	-
Marking tag		CNU/8/51 (cod. NU0851S)	CNU/8/51 (cod. NU0851S)	CNU/8/51 (cod. NU0851S)
Warning plate	on adjacent terminal blocks	PRP/7/G (cod. PRP070G)	PRP/7/G (cod. PRP070G)	PRP/7/G (cod. PRP070G)
Cover for cross-connection		-	-	-
End bracket	Snap-fit TH35 and G32	BTU (cod. BT005)	BTU (cod. BT005)	BTU (cod. BT005)
	Snap-fit TH35	BTO (cod. BT007)	BTO (cod. BT007)	BTO (cod. BT007)
	Screw TH35	BT/3 (cod. BT003)	BT/3 (cod. BT003)	BT/3 (cod. BT003)

	CESI 08 ATEX 061 U	IECEx CES 09.0002U
	II M2 Ex eb I Mb	Ex eb I Mb
	II 2 G Ex eb IIC Gb	Ex eb IIC Gb

(1) See chapter accessories for more details



GREY VERSION	CODE TYPE	CBC10GR	CBC16GR	CBC35GR
BLUE VERSION	CODE TYPE	CBI10	CBI16	CBI35
		CBC.10/GR	CBC.16/GR	CBC.35/GR
		CBC.10 (EX)I	CBC.16 (EX)I	CBC.35 (EX)I

TECHNICAL CHARACTERISTICS

Function/type		feed-through	feed-through	feed-through
Rated cross-section	(mm ²)	10	16	35
Connecting capacity	Flexible (mm ²)	1,5 ÷ 16	1,5 ÷ 25	2,5 ÷ 50
	Rigid (mm ²)	1,5 ÷ 16	1,5 ÷ 25	2,5 ÷ 50
	Max.flexible with ferrule - ferrule type (mm ²)	10 - WP100 / 21	16 - WP160 / 22	35 - WP350 / 30
Electrical characteristics According to European standard IEC EN 60947-7-1	Max AC/DC Voltage (V)	1000	1000	1000
	Max current with rated cross-section (A)	57	76	125
	Max current with Max cross-section (A)	85	114	160
	Section Caliber	B6	B7	B9
Electrical characteristics According to UL	Max AC/DC Voltage (V)	600	600	600
	Max current with rated cross-section/Factory wiring only (A)	65	100	125
	Section Min-Max (AWG)	14-6	16-3	12-1
	Tightening torque (lb.in)	17	25	75
Electrical characteristics According to ATEX directive and IEC ex standard	Max AC/DC Voltage (V)	400	500	630
	Max current with rated cross-section (A)	57	76	125
	Operating temperature (°C)	-40 ÷ +110	-40 ÷ +110	-40 ÷ +110
Rated impulse withstand voltage/pollution degree		8 KV / 3	12 KV / 3	12 KV / 3
Insulation stripping length (mm)		12	18	18
Tightening torque nominal/max (Nm)		1,2 / 1,9	2 / 3	2,5 / 5
Width (mm)		10	12	16
Length (mm)		44	47	56
Height mounted on TH35/7,5 (mm)		52	56	63
Height mounted on TH35/15 (mm)		60	64	71
Insulation material temperature index (EN 60216-1) (°C)		130	130	130
Plastic material		polyamide UL94V-0	polyamide UL94V-0	polyamide UL94V-0

APPROVALS



ACCESSORIES				
End section	Grey	CBC.2-10/PT/GR (cod. CB061GR)	CBC.16/PT/GR (cod. CB161GR)	CBC.35/PT/GR (cod. CB351GR)
	Blue	CBC.2-10/PT (Ex)I (cod. CBI061)	CBC.16/PT (Ex)I (cod. CBI161)	CBC.35/PT (Ex)I (cod. CBI351)
	Thickness (mm)	1,5	1,5	1,5
Cross connection	PTC version (1)	PTC/10/... (cod. PTC10...)	POF/53 (cod. POF53) - PFX/53 (cod. PFX53)	POF/35 (cod. POF35) - PFX/35 (cod. PFX35)
	PTP version (1)	-	-	-
	Rated current / Rated current ATEX applications (A)	57 / 47	76 / 76	125 / 125
Cross connection identification strip	green	PTC/SP (cod. PTC0990)	-	-
Disconnectable parallel bridge		-	POS/53 (cod. POS53)	-
Multiple common bar	250 mm	-	PMP/05 (cod. PMP05) 21 poles	PMP/35 (cod. PMP35) 16 poles
Shunting screw and sleeve	Standard / Ex e version	-	CPM/53 (cod. CPM53) - CPX/53 (cod. CPX53)	CPM/35 (cod. CPM35) - CPX/35 (cod. CPX35)
Coloured partition	red	DFU/4/R (cod. DU04R)	DFU/4/R (cod. DU04R)	DFU/5/R (cod. DU05R)
Cross connection barrier	red	DFM/800 (cod. DF800) - DFM/900 (cod. DF900)	DFM/700 (cod. DF700)	DFM/700 (cod. DF700)
Test plug socket		-	PSD/B (cod. PD002)	PSD/B (cod. PD002)
Test plug		-	SDD/2 (cod. DD002)	SDD/2 (cod. DD002)
Polarization insert		-	-	-
Modular test plug		-	-	-
Numbering strip		-	-	-
Marking tag		CNU/8/51 (cod. NU0851S)	CNU/8/51 (cod. NU0851S)	CNU/8/51 (cod. NU0851S)
Warning plate	on adjacent terminal blocks	PRP/7/G (cod. PRP070G)	TUM/16 (cod. TUM16)	TUM/16 (cod. TUM16)
Cover for cross-connection		-	PRP/7 (cod. PRP07)	PRP/8 (cod. PRP08)
End bracket	Snap-fit TH35 and G32	BTU (cod. BT005)	BTU (cod. BT005)	BTU (cod. BT005)
	Snap-fit TH35	BTO (cod. BT007)	BTO (cod. BT007)	BTO (cod. BT007)
	Screw TH35	BT/3 (cod. BT003)	BT/3 (cod. BT003)	BT/3 (cod. BT003)

SCREW CLAMP

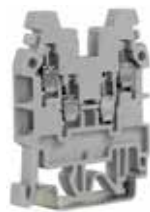

(1) See chapter accessories for more details

GREY VERSION	CODE	CR110GR
	TYPE	CBR.2/GR
BEIGE VERSION	CODE	CR110
	TYPE	CBR.2
BLUE VERSION	CODE	CI110
	TYPE	CBR.2 (EX)I

TECHNICAL CHARACTERISTICS



Function/type		distributor feed-through (2 inputs / 2 outputs)
Rated cross-section	(mm ²)	2.5
Connecting capacity	Flexible (mm ²)	0.2÷4
	Rigid (mm ²)	0.2÷4
	Max.flexible with ferrule - ferrule type (mm ²)	2.5 - WP25/14
Electrical characteristics According to European standard IEC EN 60947-7-1	Max AC/DC Voltage (V)	800
	Max current with rated cross-section (A)	24
	Section Caliber	A3
Electrical characteristics According to UL	Max AC/DC Voltage (V)	600
	Max current with rated cross-section (A)	15
	Section Min-Max (AWG)	20 - 14
	Tightening torque ((lb.in)	5,5
Rated impulse withstand voltage/pollution degree		8kV / 3
Insulation stripping length	(mm)	8
Tightening torque nominal/max	(Nm)	0,4 / 0,5
Width	(mm)	5
Length	(mm)	43
Height mounted on TH35/7,5	(mm)	52
Height mounted on TH35/15	(mm)	60
Height mounted on G32	(mm)	56
Insulation material temperature index (EN 60216-1)	(°C)	130
Plastic material		Polyamide UL94 V0

APPROVALS



ACCESSORIES		
End section	Grey	CBR/PT/GR (cod. CR111GR)
	Beige	CBR/PT (cod. CR111)
	Blue	-
	Thickness (mm)	1.5
Cross connection	(1)	PM/25/... (cod. PM25...)
	Rated current / Rated current ATEX applications (A)	24
Multiple common bar	250 mm	PMP/25 (cod. PMP25)
Shunting screw and sleeve		CPM/25 (cod. CPM25)
Coloured partition	red	DFU/4/R (cod. DU04R)
Test plug socket		PSD/K (cod. PD011)
Test plug		SDD/1 (cod. DD001)
Marking tag		CNU/8/51 (cod. NU0851S)
Cover for cross-connection		PRP/5 (cod. PRP05)
	Snap-fit TH35 and G32	BTU (cod. BT005)
End bracket	Snap-fit TH35	BTO (cod. BT007)
	Screw TH35	BT/3 (cod. BT003)
	Screw G32	BT/DIN/PO (cod. BT001)

- panel mount version - M6 screws
- possible to create parallel connections (GPA.70)



GREY VERSION	CODE TYPE	GA400GR GPA.70/GR	GF400GR GPA.70/FIX/GR
BEIGE VERSION	CODE TYPE	GA400 GPA.70	GF400 GPA.70/FIX
BLUE VERSION	CODE TYPE	GA410 GPA.70 [EXI]	

TECHNICAL CHARACTERISTICS

Function/type		feed-through	feed-through
Rated cross-section	(mm ²)	70	70
Connecting capacity	Flexible (mm ²)	10 ÷ 95	10 ÷ 95
	Rigid (mm ²)	10 ÷ 95	10 ÷ 95
Electrical characteristics According to European standard IEC EN 60947-7-1	Max AC/DC Voltage (V)	1000	1000
	Max current with rated cross-section (A)	192	192
	Section Caliber	B11	B11
Electrical characteristics According to UL	Max AC/DC Voltage (V)	600	600
	Max current with rated cross-section (A)	215	215
	Section Min-Max (AWG)	8 ÷ 4/0	8 ÷ 4/0
	Tightening torque (lb.in)	79,5	79,5
Rated impulse withstand voltage/pollution degree		12 kV / 3	12 kV / 3
Insulation stripping length	(mm)	25	25
Tightening torque nominal/max	(Nm)	6 / 9 (Allen screw, 4 mm wrench)	6 / 9 (Allen screw, 4 mm wrench)
Width	(mm)	20.5	20.5
Length	(mm)	91	102
Height mounted on TH35/7,5	(mm)	70	-
Height mounted on TH35/15	(mm)	78	-
Height mounted on G32	(mm)	75	-
Height mounted on panel	(mm)	-	65
Fixing distance between centers	(mm)	-	88
Insulation material temperature index (EN 60216-1)	(°C)	130	130
Plastic material		Polyamide UL94 V0	Polyamide UL94 V0

APPROVALS



ACCESSORIES			
Cross connection	2 poles preassembled	POF/70 (cod. POF70)	POF/70 (cod. POF70)
	Rated current (A)	192	192
Cover for cross-connection		PRP/08 (cod. PRP08)	PRP/08 (cod. PRP08)
Multiple common bar	250 mm	PMP/08 (cod. PMP08)	PMP/08 (cod. PMP08)
Shunting screw and sleeve		CPM/70 (cod. CPM70) 12 poles	CPM/70 (cod. CPM70) 12 poles
Coloured partition	red	DF/GPA/70/R (cod. DU070R)	DF/GPA/70/R (cod. DU070R)
Test plug socket		PSD/C (cod. PD003)	PSD/C (cod. PD003)
Test plug		SDD/2 (cod. DD002)	SDD/2 (cod. DD002)
Marking tag		CNU/08/51 (cod. NU0851S)	CNU/08/51 (cod. NU0851S)
		CNU/10/61 (cod. NU1061S)	CNU/10/61 (cod. NU1061S)
End bracket	Screw TH35	BT/3 (cod. BT003)	BT/3 (cod. BT003)
	Snap-fit TH35	BTO (cod. BT007)	BTO (cod. BT007)
	Snap-fit TH35 and G32	BTU (cod. BT005)	BTU (cod. BT005)

SCREW CLAMP

- same profile and dimensions of the corresponding terminal blocks of the CBC and GPA Series
- No end plates required, already closed in yellow/green shells



YELLOW/GREEN VERSION		CODE	T0120	T0510	T0220
		TYPE	TEC.6/0	TEC.10/0	TEC.16/0
TECHNICAL CHARACTERISTICS					
Function/type			earth terminal block	earth terminal block	earth terminal block
Rated cross-section		[mm ²]	6	10	16
Connecting capacity	Flexible	[mm ²]	0.5÷10	1,5 ÷ 16	1,5 ÷ 25
	Rigid	[mm ²]	0.5÷10	1,5 ÷ 16	1,5 ÷ 25
	Max. flexible with ferrule - ferrule type	[mm ²]	6 - WP60/20	10 - WP100/21	16 - WP160/22
Electrical characteristics According to European standard IEC EN 60947-7-2	Max AC/DC Voltage	[V]	-	-	-
	Max current with rated cross-section	[A]	-	-	-
Electrical characteristics According to UL	Section	Caliber	A5	B6	B7
	Max AC/DC Voltage	[V]	600	-	-
	Max current with rated cross-section	[A]	-	-	-
	Section Min-Max	[AWG]	24-8	-	-
	Tightening torque	[lb.in]	15	-	-
Rated impulse withstand voltage/pollution degree			8kV / 3	8kV / 3	8kV / 3
Insulation stripping length		[mm]	10	12	15
Tightening torque nominal/max		[Nm]	0,8 / 1,4	1,2 / 1,9	2 / 1,2
Width		[mm]	8	10	12
Length		[mm]	44	44	47
Height mounted on TH35/7,5		[mm]	52	52	56
Height mounted on TH35/15		[mm]	60	60	64
Insulation material temperature index (EN 60216-1)		[°C]	130	130	130
Plastic material			Polyamide UL94 V0	Polyamide UL94 V0	Polyamide UL94 V0
APPROVALS					
ACCESSORIES					
Marking tag			CNU/08/51 (cod. NU0851S)	CNU/08/51 (cod. NU0851S)	CNU/08/51 (cod. NU0851S)
			CNU/10/61 (cod. NU1061S)	CNU/10/61 (cod. NU1061S)	CNU/10/61 (cod. NU1061S)
End bracket	Snap-fit TH35 and G32		BTU (cod. BT005)	BTU (cod. BT005)	BTU (cod. BT005)
	Snap-fit TH35		BTO (cod. BT007)	BTO (cod. BT007)	BTO (cod. BT007)
	Screw TH35		BT/3 (cod. BT003)	BT/3 (cod. BT003)	BT/3 (cod. BT003)

MAXIMUM SHORT-TIME WITHSTAND CURRENTS ALLOCATED TO THE RAIL PROFILE

Rail profile	Material	Equivalent E-Cu cross-section mm ²	Short-time withstand current 1s kA	Thermal rated current of a PEN busbar A
Top hat rail IEC 60715/TH 15 - 5.5	Steel	10	1.2	-
	Copper	25	3	101
	Aluminium	16	1.92	76
Top hat rail IEC 60715/TH 35 - 7.5	Steel	16	1.92	-
	Copper	50	6	150
	Aluminium	35	4.2	125
Top hat rail IEC 60715/TH 35 - 15	Steel	50	6	-
	Copper	150	18	309
	Aluminium	95	11.4	232

Taken from CEI EN 60947-7-2 standard

- same profile and dimensions of the corresponding terminal blocks of the CBC and GPA Series
- No end plates required, already closed in yellow/green shells



YELLOW/GREEN VERSION		CODE	T0320	T0810
		TYPE	TEC.35/0	TEC.70/0
TECHNICAL CHARACTERISTICS				
Function/type			earth terminal block	earth terminal block
Rated cross-section		(mm ²)	35	70
Connecting capacity	Flexible	(mm ²)	2,5 ÷ 50	10 ÷ 95
	Rigid	(mm ²)	2,5 ÷ 50	10 ÷ 95
	Max. flexible with ferrule - ferrule type	(mm ²)	-	-
Electrical characteristics According to European standard IEC EN 60947-7-2	Max AC/DC Voltage	(V)	-	-
	Max current with rated cross-section	(A)	-	-
	Section	Caliber	B9	B11
Electrical characteristics According to UL	Max AC/DC Voltage	(V)	-	-
	Max current with rated cross-section	(A)	-	-
	Section Min-Max	(AWG)	-	-
	Tightening torque	(lb.in)	-	-
Rated impulse withstand voltage/pollution degree			12kV / 3	8kV / 3
Insulation stripping length		(mm)	18	25
Tightening torque nominal/max		(Nm)	2,5 / 5	6 / 9
Width		(mm)	16	20.5
Length		(mm)	56	70
Height mounted on TH35/7,5		(mm)	63	81.5
Height mounted on TH35/15		(mm)	71	74
Insulation material temperature index (EN 60216-1)		(°C)	130	130
Plastic material			Polyamide UL94 V0	Polyamide UL94 V0

APPROVALS



ACCESSORIES			
Marking tag		CNU/08/51 (cod. NU0851S)	CNU/08/51 (cod. NU0851S)
		CNU/10/61 (cod. NU1061S)	CNU/10/61 (cod. NU1061S)
End bracket	Snap-fit TH35 and G32	BTU (cod. BT005)	BTU (cod. BT005)
	Snap-fit TH35	BTO (cod. BT007)	BTO (cod. BT007)
	Screw TH35	BT/3 (cod. BT003)	BT/3 (cod. BT003)

MAXIMUM SHORT-TIME WITHSTAND CURRENTS ALLOCATED TO THE RAIL PROFILE

Rail profile	Material	Equivalent E-Cu cross-section mm ²	Short-time withstand current 1s kA	Thermal rated current of a PEN busbar A
Top hat rail IEC 60715/TH 15 - 5.5	Steel	10	1.2	-
	Copper	25	3	101
	Aluminium	16	1.92	76
Top hat rail IEC 60715/TH 35 - 7.5	Steel	16	1.92	-
	Copper	50	6	150
	Aluminium	35	4.2	125
Top hat rail IEC 60715/TH 35 - 15	Steel	50	6	-
	Copper	150	18	309
	Aluminium	95	11.4	232

Taken from CEI EN 60947-7-2 standard

15 horizontal grey bars for notes.

SCREW CLAMP

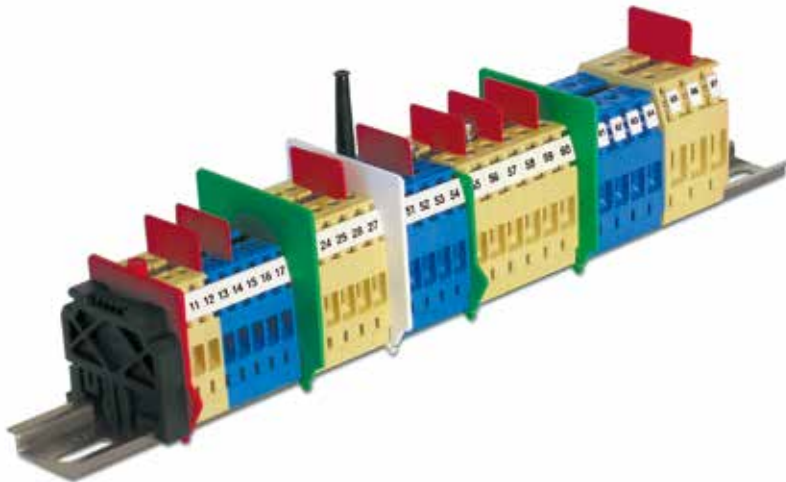

CESI 01 ATEX 090 U
I M2 Ex eb I Mb
II 2 G Ex eb IIC Gb

IECEX CES 09.0009U
Ex eb I Mb
Ex eb IIC Gb

- Behaviour in flame UL94V-0
- Universal mounting on PR/DIN and PR/3 rails in accordance with IEC 60715 standard
- Maximum continual operating temperature 130°C

The CBD Series comprises eight sizes, distinguished by:

- Very small space occupied
- Large connecting capacity
- Effective current capacity higher than established reference values
- Very low contact resistance of the connection
- Materials of excellent quality and, consequently, maximum reliability over time
- Great practicality of use

Cabur has always designated each product mainly with a Code, distinguished by a part in letters (generally 3) and a number, with an interposed dot.

This number defines the **rated cross-section** of the terminal in question; which as laid down in the reference Standard is "the figure, expressed in mm², corresponding to the section of the connectable conductor, declared by the Manufacturer, to which the thermal, mechanical and electrical parameters of the product are referred".

The field of use of the terminal block is however much wider and is defined by its connecting capacity, that is the range of sections of conductors, both rigid and flexible, minimum and maximum, that the terminal block is capable of connecting, in full observance of all the parameters laid down in the reference Standards. In the table provided below, in fact, the "classic" code of each terminal block has been supplemented with the addition, after the existing number, which still indicates the nominal size, of a second numeric value, separated from the first by a /, which represents the size, in mm², of the maximum flexible conductor effectively connectable to the terminal block. In the event of use of rigid conductors (with single wire or corded) it is necessary to check also what is stated in the technical specifications of each product, under the item "connecting capacity", because in many cases the size of the maximum rigid conductor connectable is even larger.

Type	Rated cross section (mm ²)	Flexible conductor (mm ²)		Rigid conductor (mm ²)		Gauge	Max. current (A)
		min.	max.	min.	max.		
CBD.2/4	2.5	0.5	4	0.5	4	A3	29
CBD.4/6	4	0.5	6	0.5	6	A4	40
CBD.6/10	6	0.5	10	0.5	10	A5	58
CBD.10/16	10	0.5	16	0.5	16	B6	77
CBD.16/25	16	0.5	25	0.5	25	B7	104
CBD.35/35	35	0.5	35	0.5	50	B8	147
CBD.50/50	50	1.5	50	1.0	70	B9	180
CBD.70/95	70	1.5	95	1.0	95	B11	250

APPROVALS

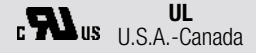

Type of connection:

It is with a screw, on both sides, indirect and self-locking. The clamping screws are accessible only with a special screwdriver and the particular shape of the head makes them impossible to lose. The screw clamping offers the best guarantees of a mechanical seal and of effective passage of the current and is suitable for the connection, with or without special preparation, of conductors of all sections. The tightening and loosening operations are extremely simple and are carried out with commonly-used tools, namely screwdrivers; it is however important, in any case, to use screwdrivers of the right characteristics and dimensions so as not to cause damage either to the screw itself or to the insulating base.

Conducting body:

of the sleeve type, **made entirely of copper-zinc alloy with nickel-plating treatment**; the characteristics of the material used and the manufacturing methods are such as to avoid the phenomenon of possible breakages, known as "seasoning cracks".

Tightening reliability:

opportune orthogonal ribs, at the bottom of the sleeve and on the lower surface of the clamping platelets, ensure in the various situations perfect electrical contact with the conductors and efficient mechanical locking. The grip on the conductor is made particularly effective by the elastic function performed by the clamping platelet; this, in particular, under the pressure of the screw, tends to bend, thus exercising a reaction applied to the head of the screw itself, which opposes unscrewing, even in the presence of dynamic stresses (vibrations).

Ease of insertion:

Inserting the conductor in the terminal block is facilitated:

- by the inclined invitation surfaces made on the insulating base
- by the rounded shape of the clamping platelet
- by the adequate size of the introduction hole with respect to the diameter of the maximum insertable conductor. The conductor introduction depth is limited by a barrier fitted on the insulating base.

Other functions:

besides their main function of feed-through terminal blocks, the CBD terminal blocks are designed and made so as to be able to perform other functions. In fact, using a hole made in the upper part of the conducting body it is possible:

- to create a fixed or switchable transversal connection (cross connection) between two adjoining terminal blocks
- to create a multiple common bar connection between several adjoining terminal blocks
- to insert a socket for a test plug
- to insert a composable test plug for multiple signal testing.

Marking: all CBD terminal blocks offer the possibility of coding, on both sides, using the CNU/8, CNU/10 or CSC marking tags (this last system enables the composition of alphanumeric codes up to a maximum of four characters, six with the ADR/6 adapter).

Mounting: the polyamide terminal blocks of the CBD Series are made ready to be mounted indifferently on supporting rails of G32 or TH/35 type (IEC 60715 standard), with evident advantages and facilitations in procuring, managing and in general using the product.



TH/35-7.5 rail



TH/35-15 rail



"G 32"-type rail



CNU marking



CSC marking

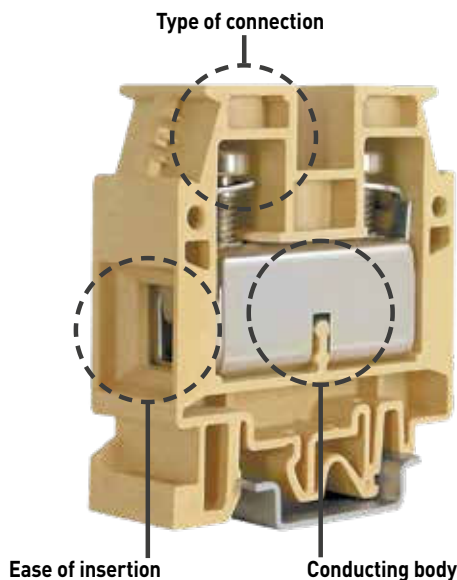

SCREW CLAMP



CESI 01 ATEX 090 U
I M2 Ex eb I Mb
II 2 G Ex eb IIC Gb

IECEx CES 09.0009U
Ex eb I Mb
Ex eb IIC Gb

(1) See chapter accessories for more details

(2) If you need to connect shielded cable with CB009 accessory, the rated voltage is reduced to 200V



BEIGE VERSION	CODE	CB110	CB240	CB340
BLUE VERSION	CODE	CBX12	CBX24	CBX34
	TYPE	CBD.2	CBD.4	CBD.6
	TYPE	CBD.2 (EX)I	CBD.4 (EX)I	CBD.6 (EX)I
GREY VERSION	CODE			
	TYPE			

TECHNICAL CHARACTERISTICS

Function/type		Feed-through	Feed-through	Feed-through
Rated cross-section	(mm ²)	2.5	4	6
Connecting capacity	Flexible (mm ²)	0.5 - 4	0.5 - 6	0.5 - 10
	Rigid (mm ²)	0.5 - 4	0.5 - 6	0.5 - 10
	Max. flexible with ferrule - ferrule type (mm ²)	2.5 - WP25/14	4 - WP40/16	6 - WP60/20
Electrical characteristics According to European standard IEC EN 60947-7-1	Max AC/DC Voltage (V)	690	1000	1000
	Max current with rated cross-section (A)	24	32	41
	Section Caliber	A3	A4	A5
Electrical characteristics According to UL	Max AC/DC Voltage (V)	600	600	600
	Max current with rated cross-section (A)	20 / 25	30 / 32	50
	Section Min-Max (AWG)	20 - 12	20 - 10	20 - 8
	Tightening torque (lb.in)	5.5	8.9	13.3
Electrical characteristics According to ATEX directive and IEC ex standard	Max AC/DC voltage with G32 rail / TH35 rail (V)	400 / 630	500 / 630	500 / 630
	Max current with rated cross-section (A)	24	32	41
	Operating Temperature (°C)	-40 ÷ +110	-40 ÷ +110	-40 ÷ +110
Rated impulse withstand voltage/pollution degree		8kV/3	12kV/3	12kV/3
Insulation stripping length (mm)		13	14	14
Tightening torque nominal/max (Nm)		0.4 / 0.8	0.5 / 1.2	0.8 / 1.4
Width (mm)		5.5	6.5	8
Length (mm)		40.5	44	44
Height mounted on TH35/7,5 (mm)		47	52	52
Height mounted on TH35/15 (mm)		55	60	60
Height mounted on G32 (mm)		51	56	56
Insulation material temperature index (EN 60216-1) (°C)		130	130	130
Plastic material		Polyamide UL94 V0	Polyamide UL94 V0	Polyamide UL94 V0

APPROVALS

--	--	--	--

ACCESSORIES

End section	Grey	-	-	-
	Blue	CB2/PT (Ex)I (cod. CBX13)	CB4/6/PT (Ex)I (cod. CBX25)	CB4/6/PT (Ex)I (cod. CBX25)
	Beige	CB2/PT (cod. CB111)	CB4/6/PT (cod. CB241)	CB4/6/PT (cod. CB241)
	Thickness (mm)	1.5	1.5	1.5
Cross connection	(1)	PM/20/... (cod. PM2...)	PM/40/... (cod. PM4...)	PM/60/... (cod. PM6...)
	Rated current / Rated current ATEX applications (A)	24 / 24	32 / 32	41 / 41
Switchable cross connection		POS/11 (cod. POS11)	POS/42 (cod. POS42)	POS/93 (cod. POS93)
Multiple common bar	250 mm	PMP/01/45 (cod. PMP01) 45 poles	PMP/42/38 (cod. PMP42) 38 poles	PMP/13/31 (cod. PMP13) 31 poles
Shunting screw and sleeve (same, Ex e version)		CPM/21 (cod. CPM21) - CPX/21 (cod. CPX21)	CPM/12 (cod. CPM12) - CPX/12 (cod. CPX12)	CPM/83 (cod. CPM83) - CPX/83 (cod. CPX83)
Coloured partition	red	DFU/1/R (cod. DU01R)	DFU/4/R (cod. DU04R)	DFU/4/R (cod. DU04R)
Cross connection barrier	red	DFM/600 (cod. DF600)	DFM/600 (cod. DF600)	DFM/600 (cod. DF600)
Test plug socket		PSD/D (cod. PD004)	PSD/D (cod. PD004)	PSD/N (cod. PD013)
Test plug		SDD/1 (cod. DD001)	SDD/1 (cod. DD001)	SDD/1 (cod. DD001)
Modular test plug		SDD/5 (cod. DD005)	SDD/6 (cod. DD006)	-
End section for modular test plug		SD5/PT (cod. DD501)	SD6/PT (cod. DD601)	-
Adhesive numbering strip		TMM102105AW	TMM102105AW	TMM102105AW
Warning plate	on adjacent terminal blocks	TQM/02 on 4 (cod. TQM02)	TTM/12 on 3 and on 4 (cod. TTM12)	TTM/15 on 3 (cod. TTM15) - TQM/15 on 4 (cod. TQM15)
Cover for cross-connection		PRP/6 (cod. PRP06)	PRP/6 (cod. PRP06)	PRP/7 (cod. PRP07)
Marking tag		CNU/8/51 (cod. NU0851S) CNU/10/61 (cod. NU1061S)	CNU/8/51 (cod. NU0851S) CNU/10/61 (cod. NU1061S)	CNU/8/51 (cod. NU0851S) CNU/10/61 (cod. NU1061S)
End bracket	Snap-fit TH35 and G32	BTU (cod. BT005)	BTU (cod. BT005)	BTU (cod. BT005)
	Snap-fit TH35	BTO (cod. BT007)	BTO (cod. BT007)	BTO (cod. BT007)
	Screw TH35	BT/3 (cod. BT003)	BT/3 (cod. BT003)	BT/3 (cod. BT003)
	Screw G32	BT/DIN/PO (cod. BT001)	BT/DIN/PO (cod. BT001)	BT/DIN/PO (cod. BT001)
Screening lug	(2)	CBD/SH (cod. CB009)	CBD/SH (cod. CB009)	CBD/SH (cod. CB009)



CESI 01 ATEX 090 U
I M2 Ex eb I Mb
II 2 G Ex eb IIC Gb

IECEx CES 09.0009U
Ex eb I Mb
Ex eb IIC Gb



BEIGE VERSION	CODE	CB710	CB810
	TYPE	CBD.50	CBD.70
BLUE VERSION	CODE	CBX72	CBX82
	TYPE	CBD.50 (EX)I	CBD.70 (EX)I
GREY VERSION	CODE	CB710GR	CB810GR
	TYPE	CBD.50/GR	CBD.70/GR

TECHNICAL CHARACTERISTICS

Function/type		Feed-through	Feed-through
Rated cross-section	(mm ²)	50	70
Connecting capacity	Flexible (mm ²)	1.5 - 50	1.5 - 95
	Rigid (mm ²)	1 - 70	1 - 95
	Max. flexible with ferrule - ferrule type (mm ²)	50 - WP500/40	-
Electrical characteristics According to European standard IEC EN 60947-7-1	Max AC/DC Voltage (V)	1000	1000
	Max current with rated cross-section (A)	150	192
	Section Caliber	B9	B11
Electrical characteristics According to UL	Max AC/DC Voltage (V)	600	600
	Max current with rated cross-section (A)	130	220
	Section Min-Max (AWG)	16 - 1	12 - 4/0
Electrical characteristics According to ATEX directive and IEC ex standard	Tightening torque (lb.in)	33.2	50
	Max AC/DC voltage with G32 rail / TH35 rail (V)	630 / 630	630 / 630
	Max current with rated cross-section (A)	150	173
Operating Temperature (°C)	-40 ÷ +110	-40 ÷ +110	
Rated impulse withstand voltage/pollution degree		12 KV / 3	12 KV / 3
Insulation stripping length (mm)		22	26
Tightening torque nominal/max (Nm)		2,5 / 5	3 / 8
Width (mm)		18	20,5
Length (mm)		57	62
Height mounted on TH35/7,5 (mm)		62	71
Height mounted on TH35/15 (mm)		70	79
Height mounted on G32 (mm)		66	75
Insulation material temperature index (EN 60216-1) (°C)		130	130
Plastic material		Polyamide UL94 V0	Polyamide UL94 V0

APPROVALS



ACCESSORIES

End section	Grey	CB50/PT/GR (cod. CB711GR)	CB70/PT/GR (cod. CB811GR)
	Blue	CB50/PT (Ex)i (cod. CBX73)	CB70/PT (Ex)i (cod. CBX83)
	Beige	CB50/PT (cod. CB711)	CB70/PT (cod. CB811)
	Thickness (mm)	1.5	1.5
Cross connection	(1)	POF/07 (cod. POF07) - PFX/07 (cod. PFX07)	POF/08 (cod. POF08) - PFX/08 (cod. PFX08)
	Rated current / Rated current ATEX applications (A)	150 / 150	192 / 155
Switchable cross connection		POS/77 (cod. POS77)	POS/08 (cod. POS08)
Multiple common bar 250 mm		PMP/07/14 (cod. PMP07) 14 poles	PMP/08/12 (cod. PMP08) 12 poles
Shunting screw and sleeve (same, Ex e version)		CPM/07 (cod. CPM07) - CPX/07 (cod. CPX07)	CPM/08 (cod. CPM08) - CPX/08 (cod. CPX08)
Coloured partition red		DFU/5/R (cod. DU05R)	DFU/6/R (cod. DU06R)
Cross connection barrier red		DFM/700 (cod. DF700)	DFM/700 (cod. DF700)
Test plug socket		PSD/C (cod. PD003)	PSD/C (cod. PD003)
Test plug		SDD/2 (cod. DD002)	SDD/2 (cod. DD002)
Modular test plug		-	-
End section for modular test plug		-	-
Adhesive numbering strip		TMM102105AW	TMM102105AW
Warning plate on adjacent terminal blocks		TUM/07 on 3 and on 4 TUM07	TUM/08 on 3 and on 4 TUM08
Cover for cross-connection		PRP/8 (cod. PRP08)	PRP/8 (cod. PRP08)
Marking tag		CNU/8/51 (cod. NU0851S)	CNU/8/51 (cod. NU0851S)
		CNU/10/61 (cod. NU1061S)	CNU/10/61 (cod. NU1061S)
		BTU (cod. BT005)	BTU (cod. BT005)
End bracket	Snap-fit TH35 and G32	BTU (cod. BT005)	BTU (cod. BT005)
	Snap-fit TH35	BTO (cod. BT007)	BTO (cod. BT007)
	Screw TH35	BT/3 (cod. BT003)	BT/3 (cod. BT003)
	Screw G32	BT/DIN/PO (cod. BT001)	BT/DIN/PO (cod. BT001)
Screening lug (2)		-	-



CES1 13 ATEX 038 U
I M2 Ex eb I Mb
II 2 G Ex eb IIC Gb

IECEX CES 13.0012U
Ex eb I Mb
Ex eb IIC Gb

- Mounting for both PR/DIN and PR/3 rails which meet IEC 60715 norms, "G32" and TH/35 types
- Nominal voltage 1000 V
- Panel mount version
- Possibility of parallel cross connection
- Available in the /BB (bar-bar), /BC (bar-cable), /CC (cable-cable) versions
- Available in grey and beige
- Maximum continual operating temperature 130°C

Tightening reliability: the reliability of the connection (wire terminal or bar) is guaranteed by a screw and locking nut, with the interposition of a flat washer and an elastic washer, useful above all for countering the effects of the dynamic stresses. In the versions made ready for clamping of the conductors, without preparation. The reliability of the connection is ensured by the action and the particular wrapping shape of the clamping clip, the elastic reaction of which to the force pressing down on the conductor works as a lock under the head of the clamping screw, stopping it from loosening, even in the presence of vibrations. The conductor bar is also made with an appropriate concave seat so as to increase the grip of the conductors; in addition both the contact surface of the clamping clip and the concave part of the bar feature, along the entire length, crosswise channels that help to improve the connection characteristics, as regards both the mechanical retention of the conductors and the electrical contact, guaranteeing low contact resistances.

- Protection for the "bar" versions: this protection which in the normal installation conditions has a longitudinal position with respect to the axis of the terminal block, can easily be rotated, using a simple screwdriver (as prescribed by the safety standards). In this way it is possible to access the connection unit to be able to work on the wire terminals or on the bars;

- Protection for the "cable" versions: in this case the protection is fixed and snaps in: its development is orthogonal to the axis of the terminal block and it protects the collar, the clip and the clamping screw. It is worth noting the "shutter" device, fitted on the protection in axis to the terminal block and in line with the conductor introduction hole, which enables, with manual action in maximum conditions of safety, partial or total closing of the hole itself and consequently protection of the live parts, in the case of use of conductors with a much smaller section than the nominal one or cabling of the terminal block from only one side.

Mounting: for these power terminal blocks, owing to the notable dimensions and because they are subject to high stresses due to the forces generated by the conductors, a new hooking system has been studied and created. This enables it to be mounted indifferently on the various types of standard mounting rail (IEC 60715). The terminal block is unhooked simply using a screwdriver, inserted in the special slot provided in the hooking system (yellow part). If the mounting rail itself is installed on a flat wall, the dimensions of the GPM terminal blocks make it indispensable to use flat brackets to space the terminal board from the surface adequately. For each terminal block of the Series the version for direct fixing to a panel (/ FIX) is also available.

Marking: the GPM terminal blocks enable identification from both sides which can be done with both the CNU/8 (2 elements) and the CSC (up to 5 elements) type marking tags: the two possibilities are not alternatives, but can be combined.

Cross-connection: on this Series of terminal blocks it is also possible to create a cross connection between 2 or 3 adjacent terminal blocks using opportune cross connections; to insert this accessory it is necessary to remove the insulating baffle pre-engraved on the side wall of the insulating body.

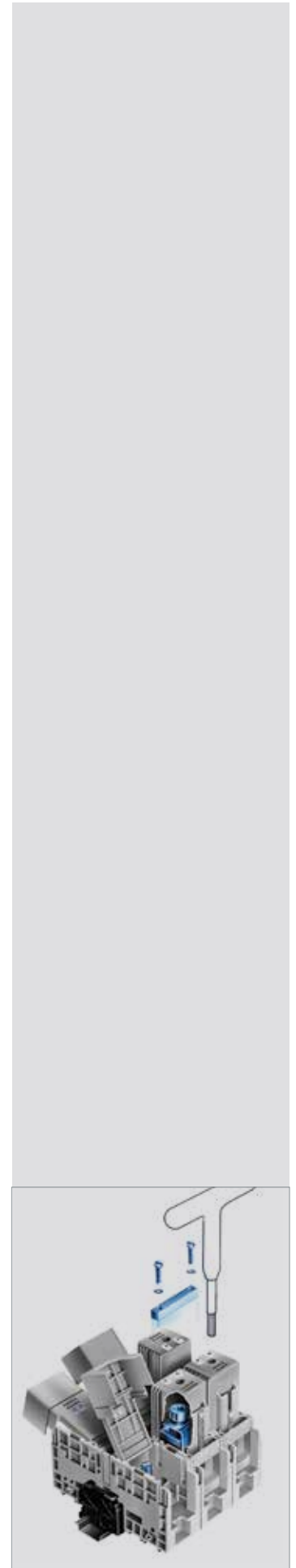

SCREW CLAMP

- panel mount version - M6 screws (recommended with screwdriver and washer slot)
- possibility of parallel cross connection

	CESI 13 ATEX 038 U	IECEx CES 13.0012U
	I M2 Ex e I Mb	Ex e I Mb
	II 2 G Ex e IIC Gb	Ex e IIC Gb



(1) See chapter accessories for more details

BEIGE VERSION	CODE TYPE	GP100	GP110
		GPM.95/BB	GPM.95/BB/FIX
GREY VERSION	CODE TYPE	GP100GR	GP110GR
		GPM.95/BB/GR	GPM.95/BB/FIX/GR

TECHNICAL CHARACTERISTICS

Function/type		GP100	GP110
Rated cross-section	(mm ²)	95	95
Connecting capacity	Flexible (mm ²)	-	-
	Rigid (mm ²)	-	-
Bars and/or cable lugs	Maximum width / bolt (mm)	22 / M8	22 / M8
Electrical characteristics According to European standard IEC EN 60947-7-1	Max AC/DC Voltage (V)	1000	1000
	Max current with rated cross-section (A)	232	232
	Max current with Max cross-section (A)	320	320
	Section (Caliber)	-	-
Electrical characteristics According to ATEX directive and IEC ex standard	Max AC/DC Voltage (V)	630	630
	Max current with rated cross-section (A)	232	232
	Operating Temperature (°C)	-40 ÷ +80	-40 ÷ +80
Rated impulse withstand voltage/pollution degree		12 KV / 3	12 KV / 3
Insulation stripping length	(mm)	-	-
Tightening torque nominal/max	Bar (Nm)	6 / 9	6 / 9
	Cable (Nm)	-	-
Width	(mm)	32	32
Length	(mm)	176	-
Height mounted on TH35/7,5	(mm)	81	-
Height mounted on TH35/15	(mm)	88	-
Height mounted on G32	(mm)	85	-
Height panel mount	(mm)	-	76
Length panel mount	(mm)	-	176
Fixing distance between centres	(mm)	-	158
Insulation material temperature index (EN 60216-1)	(°C)	130	130
Plastic material		Polyamide UL94 V0	Polyamide UL94 V0

APPROVALS



ACCESSORIES		GP100	GP110
Permanent cross connection	(1)	POF/95/... (cod. P095...)	POF/95/... (cod. P095...)
	Rated current (A)	-	-
Mounting rail support	flat for PR/DIN e PR/3	ACI121213 (cod. Z121213)	ACI121213 (cod. Z121213)
	sloped for PR/DIN e PR/3	ACI121024 (cod. Z121024)	ACI121024 (cod. Z121024)
Marking tag		CNU/08/51 (cod. NU0851S)	CNU/08/51 (cod. NU0851S)
		CNU/10/61 (cod. NU1061S)	CNU/10/61 (cod. NU1061S)
End bracket	Snap-fit TH35 and G32	BTU (cod. BT005)	BTU (cod. BT005)
	Snap-fit TH35	BTO (cod. BT007)	BTO (cod. BT007)
	Screw TH35	BT/3 (cod. BT003)	BT/3 (cod. BT003)

- panel mount version - M6 screws (recommended with screwdriver and washer slot)
- possibility of parallel cross connection



CESI 13 ATEX 038 U
I M2 Ex e I Mb
II 2 G Ex e IIC Gb

IECEx CES 13.0012U
Ex e I Mb
Ex e IIC Gb

(1) See chapter accessories for more details

BEIGE VERSION	CODE TYPE	GP400	GP410
		GPM.150/BB	GPM.150/BB/FIX
GREY VERSION	CODE TYPE	GP400GR	GP410GR
		GPM.150/BB/GR	GPM.150/BB/FIX/GR

TECHNICAL CHARACTERISTICS

Function/type		feed-through	feed-through
Rated cross-section	(mm ²)	150	150
Connecting capacity	Flexible (mm ²)	-	-
	Rigid (mm ²)	-	-
Bars and/or cable lugs	Maximum width / bolt (mm)	32 / M10	32 / M10
Electrical characteristics According to European standard IEC EN 60947-7-1	Max AC/DC Voltage (V)	1000	1000
	Max current with rated cross-section (A)	309	309
	Max current with Max cross-section (A)	440	440
	Section (Caliber)	-	-
Electrical characteristics According to ATEX directive and IEC ex standard	Max AC/DC Voltage (V)	1000	1000
	Max current with rated cross-section (A)	309	309
	Operating Temperature (°C)	-40 ÷ +80	-40 ÷ +80
Rated impulse withstand voltage/pollution degree		12 KV / 3	12 KV / 3
Insulation stripping length	(mm)	-	-
Tightening torque nominal/max	Bar (Nm)	10 / 15	10 / 15
	Cable (Nm)	-	-
Width	(mm)	42	42
Length	(mm)	200	-
Height mounted on TH35/7,5	(mm)	81	-
Height mounted on TH35/15	(mm)	88	-
Height mounted on G32	(mm)	85	-
Height panel mount	(mm)	-	76
Length panel mount	(mm)	-	200
Fixing distance between centres	(mm)	-	158
Insulation material temperature index (EN 60216-1)	(°C)	130	130
Plastic material		Polyamide UL94 V0	Polyamide UL94 V0

APPROVALS



ACCESSORIES			
Permanent cross connection	(1)	PFX/150/... (cod. PX15...)	PFX/150/... (cod. PX15...)
	Rated current (A)	-	-
Mounting rail support	flat for PR/DIN e PR/3	ACI121213 (cod. Z121213)	ACI121213 (cod. Z121213)
	sloped for PR/DIN e PR/3	ACI121024 (cod. Z121024)	ACI121024 (cod. Z121024)
Marking tag		CNU/08/51 (cod. NU0851S)	CNU/08/51 (cod. NU0851S)
		CNU/10/61 (cod. NU1061S)	CNU/10/61 (cod. NU1061S)
End bracket	Snap-fit TH35 and G32	BTU (cod. BT005)	BTU (cod. BT005)
	Snap-fit TH35	BTO (cod. BT007)	BTO (cod. BT007)
	Screw TH35	BT/3 (cod. BT003)	BT/3 (cod. BT003)

SCREW CLAMP

- panel mount version - M6 screws (recommended with screwdriver and washer slot)
- possibility of parallel cross connection

	CESI 13 ATEX 038 U	IECEx CES 13.0012U
	I M2 Ex e I Mb	Ex e I Mb
	II 2 G Ex e IIC Gb	Ex e IIC Gb



(1) See chapter accessories for more details

BEIGE VERSION	CODE TYPE	GP700 GPM.240/BB	GP710 GPM.240/BB/FIX
GREY VERSION	CODE TYPE	GP700GR GPM.240/BB/GR	GP710GR GPM.240/BB/FIX/GR



TECHNICAL CHARACTERISTICS

Function/type		GP700	GP710
Rated cross-section	(mm ²)	240	240
Connecting capacity	Flexible (mm ²)	-	-
	Rigid (mm ²)	-	-
Bars and/or cable lugs	Maximum width / bolt (mm)	40 / M12	40 / M12
Electrical characteristics According to European standard IEC EN 60947-7-1	Max AC/DC Voltage (V)	1000	1000
	Max current with rated cross-section (A)	415	415
	Max current with Max cross-section (A)	600	600
	Section (Caliber)	-	-
Electrical characteristics According to ATEX directive and IEC ex standard	Max AC/DC Voltage (V)	1000	1000
	Max current with rated cross-section (A)	415	415
	Operating Temperature (°C)	-40 ÷ +80	-40 ÷ +80
Rated impulse withstand voltage/pollution degree		12 KV / 3	12 KV / 3
Insulation stripping length	(mm)	-	-
Tightening torque nominal/max	Bar (Nm)	14 / 21	14 / 21
	Cable (Nm)	-	-
Width	(mm)	52	52
Length	(mm)	250	-
Height mounted on TH35/7,5	(mm)	89	-
Height mounted on TH35/15	(mm)	96	-
Height mounted on G32	(mm)	93	-
Height panel mount	(mm)	-	84
Length panel mount	(mm)	-	250
Fixing distance between centres	(mm)	-	172
Insulation material temperature index (EN 60216-1)	(°C)	130	130
Plastic material		Polyamide UL94 V0	Polyamide UL94 V0

APPROVALS



ACCESSORIES

Accessory	GP700	GP710
Permanent cross connection	PFX/240/... (cod. PX24...)	PFX/240/... (cod. PX24...)
Rated current (A)	-	-
Mounting rail support	ACI121213 (cod. Z121213)	ACI121213 (cod. Z121213)
	ACI121024 (cod. Z121024)	ACI121024 (cod. Z121024)
Marking tag	CNU/08/51 (cod. NU0851S)	CNU/08/51 (cod. NU0851S)
	CNU/10/61 (cod. NU1061S)	CNU/10/61 (cod. NU1061S)
End bracket	BTU (cod. BT005)	BTU (cod. BT005)
	BTO (cod. BT007)	BTO (cod. BT007)
	BT/3 (cod. BT003)	BT/3 (cod. BT003)

- panel mount version - M6 screws (recommended with screwdriver and washer slot)
- possibility of parallel cross connection



Ex CESI 13 ATEX 038 U
I M2 Ex e I Mb
II 2 G Ex e IIC Gb

IECEx CES 13.0012U
Ex e I Mb
Ex e IIC Gb

(1) See chapter accessories for more details

BEIGE VERSION	CODE TYPE	GP200	GP210
		GPM.95/BC	GPM.95/BC/FIX
GREY VERSION	CODE TYPE	GP200GR	GP210GR
		GPM.95/BC/GR	GPM.95/BC/FIX/GR

TECHNICAL CHARACTERISTICS

Function/type		feed-through	feed-through
Rated cross-section	(mm ²)	95	95
Connecting capacity	Flexible (mm ²)	35 ÷ 95	35 ÷ 95
	Rigid (mm ²)	25 ÷ 120	25 ÷ 120
Bars and/or cable lugs	Maximum width / bolt (mm)	22 / M8	22 / M8
Electrical characteristics According to European standard IEC EN 60947-7-1	Max AC/DC Voltage (V)	1000	1000
	Max current with rated cross-section (A)	232	232
	Max current with Max cross-section (A)	320	320
	Section (Caliber)	B12	B12
Electrical characteristics According to ATEX directive and IEC ex standard	Max AC/DC Voltage (V)	630	630
	Max current with rated cross-section (A)	232	232
	Operating Temperature (°C)	-40 ÷ +80	-40 ÷ +80
Rated impulse withstand voltage/pollution degree		12 KV / 3	12 KV / 3
Insulation stripping length	(mm)	35	35
Tightening torque nominal/max	Bar (Nm)	6 / 9	6 / 9
	Cable (Nm)	6 / 9	6 / 9
Width	(mm)	32	32
Length	(mm)	158	-
Height mounted on TH35/7,5	(mm)	113	-
Height mounted on TH35/15	(mm)	120	-
Height mounted on G32	(mm)	117	-
Height panel mount	(mm)	-	108
Length panel mount	(mm)	-	175
Fixing distance between centres	(mm)	-	158
Insulation material temperature index (EN 60216-1)	(°C)	130	130
Plastic material		Polyamide UL94 V0	Polyamide UL94 V0

APPROVALS



ACCESSORIES			
Permanent cross connection	(1)	POF/95/... (cod. P095...)	POF/95/... (cod. P095...)
	Rated current (A)	-	-
Mounting rail support	flat for PR/DIN e PR/3	ACI121213 (cod. Z121213)	ACI121213 (cod. Z121213)
	sloped for PR/DIN e PR/3	ACI121024 (cod. Z121024)	ACI121024 (cod. Z121024)
Marking tag		CNU/08/51 (cod. NU0851S)	CNU/08/51 (cod. NU0851S)
		CNU/10/61 (cod. NU1061S)	CNU/10/61 (cod. NU1061S)
End bracket	Snap-fit TH35 and G32	BTU (cod. BT005)	BTU (cod. BT005)
	Snap-fit TH35	BTO (cod. BT007)	BTO (cod. BT007)
	Screw TH35	BT/3 (cod. BT003)	BT/3 (cod. BT003)

- panel mount version - M6 screws (recommended with screwdriver and washer slot)
- possibility of parallel cross connection

	CESI 13 ATEX 038 U	IECEx CES 13.0012U
	I M2 Ex e I Mb	Ex e I Mb
	II 2 G Ex e IIC Gb	Ex e IIC Gb

(1) See chapter accessories for more details



BEIGE VERSION	CODE TYPE	GP500	GP510
		GPM.150/BC	GPM.150/BC/FIX
GREY VERSION	CODE TYPE	GP500GR	GP510GR
		GPM.150/BC/GR	GPM.150/BC/FIX/GR

TECHNICAL CHARACTERISTICS

Function/type		GP500	GP510
Rated cross-section	(mm ²)	150	150
Connecting capacity	Flexible (mm ²)	50 ÷ 150	50 ÷ 150
	Rigid (mm ²)	35 ÷ 185	35 ÷ 185
Bars and/or cable lugs	Maximum width / bolt (mm)	32 / M10	32 / M10
Electrical characteristics According to European standard IEC EN 60947-7-1	Max AC/DC Voltage (V)	1000	1000
	Max current with rated cross-section (A)	309	309
	Max current with Max cross-section (A)	440	440
	Section (Caliber)	B14	B14
Electrical characteristics According to ATEX directive and IEC ex standard	Max AC/DC Voltage (V)	1000	1000
	Max current with rated cross-section (A)	309	309
	Operating Temperature (°C)	-40 ÷ +80	-40 ÷ +80
Rated impulse withstand voltage/pollution degree		12 KV / 3	12 KV / 3
Insulation stripping length (mm)		35	35
Tightening torque nominal/max	Bar (Nm)	10 / 15	10 / 15
	Cable (Nm)	10 / 15	10 / 15
Width (mm)		42	42
Length (mm)		170	-
Height mounted on TH35/7,5 (mm)		134	-
Height mounted on TH35/15 (mm)		141	-
Height mounted on G32 (mm)		138	-
Height panel mount (mm)		-	129
Length panel mount (mm)		-	187
Fixing distance between centres (mm)		-	158
Insulation material temperature index (EN 60216-1) (°C)		130	130
Plastic material		Polyamide UL94 V0	Polyamide UL94 V0

APPROVALS



ACCESSORIES		GP500	GP510
Permanent cross connection	(1)	PFX/150/... (cod. PX15...)	PFX/150/... (cod. PX15...)
	Rated current (A)	-	-
Mounting rail support	flat for PR/DIN e PR/3	ACI121213 (cod. Z121213)	ACI121213 (cod. Z121213)
	sloped for PR/DIN e PR/3	ACI121024 (cod. Z121024)	ACI121024 (cod. Z121024)
Marking tag		CNU/08/51 (cod. NU0851S)	CNU/08/51 (cod. NU0851S)
		CNU/10/61 (cod. NU1061S)	CNU/10/61 (cod. NU1061S)
End bracket	Snap-fit TH35 and G32	BTU (cod. BT005)	BTU (cod. BT005)
	Snap-fit TH35	BTO (cod. BT007)	BTO (cod. BT007)
	Screw TH35	BT/3 (cod. BT003)	BT/3 (cod. BT003)

- panel mount version - M6 screws (recommended with screwdriver and washer slot)
- possibility of parallel cross connection



CESI 13 ATEX 038 U
I M2 Ex e I Mb
II 2 G Ex e IIC Gb

IECEx CES 13.0012U
Ex e I Mb
Ex e IIC Gb

(1) See chapter accessories for more details

BEIGE VERSION	CODE TYPE	GP800	GP810
		GPM.240/BC	GPM.240/BC/FIX
GREY VERSION	CODE TYPE	GP800GR	GP810GR
		GPM.240/BC/GR	GPM.240/BC/FIX/GR



TECHNICAL CHARACTERISTICS

Function/type		feed-through	feed-through
Rated cross-section	(mm ²)	240	240
Connecting capacity	Flexible (mm ²)	95 ÷ 240	95 ÷ 240
	Rigid (mm ²)	50 ÷ 300	50 ÷ 300
Bars and/or cable lugs	Maximum width / bolt (mm)	40 / M12	40 / M12
Electrical characteristics According to European standard IEC EN 60947-7-1	Max AC/DC Voltage (V)	1000	1000
	Max current with rated cross-section (A)	415	415
	Max current with Max cross-section (A)	600	600
	Section (Caliber)	B16	B16
Electrical characteristics According to ATEX directive and IEC ex standard	Max AC/DC Voltage (V)	1000	1000
	Max current with rated cross-section (A)	415	415
	Operating Temperature (°C)	-40 ÷ +80	-40 ÷ +80
Rated impulse withstand voltage/pollution degree		12 KV / 3	12 KV / 3
Insulation stripping length	(mm)	43	43
Tightening torque nominal/max	Bar (Nm)	14 / 21	14 / 21
	Cable (Nm)	14 / 21	14 / 21
Width	(mm)	52	52
Length	(mm)	202	-
Height mounted on TH35/7,5	(mm)	150	-
Height mounted on TH35/15	(mm)	157	-
Height mounted on G32	(mm)	154	-
Height panel mount	(mm)	-	144
Length panel mount	(mm)	-	219
Fixing distance between centres	(mm)	-	172
Insulation material temperature index (EN 60216-1)	(°C)	130	130
Plastic material		Polyamide UL94 V0	Polyamide UL94 V0

APPROVALS



ACCESSORIES			
Permanent cross connection	(1)	PFX/240/... (cod. PX24...)	PFX/240/... (cod. PX24...)
	Rated current (A)	-	-
Mounting rail support	flat for PR/DIN e PR/3	ACI121213 (cod. Z121213)	ACI121213 (cod. Z121213)
	sloped for PR/DIN e PR/3	ACI121024 (cod. Z121024)	ACI121024 (cod. Z121024)
Marking tag		CNU/08/51 (cod. NU0851S)	CNU/08/51 (cod. NU0851S)
		CNU/10/61 (cod. NU1061S)	CNU/10/61 (cod. NU1061S)
End bracket	Snap-fit TH35 and G32	BTU (cod. BT005)	BTU (cod. BT005)
	Snap-fit TH35	BTO (cod. BT007)	BTO (cod. BT007)
	Screw TH35	BT/3 (cod. BT003)	BT/3 (cod. BT003)

- panel mount version - M6 screws (recommended with screwdriver and washer slot)
- possibility of parallel cross connection



Ex CESI 13 ATEX 038 U
I M2 Ex e I Mb
II 2 G Ex e IIC Gb

IECEx CES 13.0012U
Ex e I Mb
Ex e IIC Gb

(1) See chapter accessories for more details

BEIGE VERSION	CODE TYPE	GP300	GP310
		GPM.95/CC	GPM.95/CC/FIX
GREY VERSION	CODE TYPE	GP300GR	GP310GR
		GPM.95/CC/GR	GPM.95/CC/FIX/GR

TECHNICAL CHARACTERISTICS

Function/type		feed-through	feed-through
Rated cross-section	(mm ²)	95	95
Connecting capacity	Flexible (mm ²)	35 ÷ 95	35 ÷ 95
	Rigid (mm ²)	25 ÷ 120	25 ÷ 120
Bars and/or cable lugs	Maximum width / bolt (mm)	-	-
Electrical characteristics According to European standard IEC EN 60947-7-1	Max AC/DC Voltage (V)	1000	1000
	Max current with rated cross-section (A)	232	232
	Max current with Max cross-section (A)	320	320
	Section (Caliber)	B12	B12
Electrical characteristics According to ATEX directive and IEC ex standard	Max AC/DC Voltage (V)	630	630
	Max current with rated cross-section (A)	232	232
	Operating Temperature (°C)	-40 ÷ +80	-40 ÷ +80
Rated impulse withstand voltage/pollution degree		12 KV / 3	12 KV / 3
Insulation stripping length (mm)		35	35
Tightening torque nominal/max	Bar (Nm)	-	-
	Cable (Nm)	6 / 9	6 / 9
Width (mm)		32	32
Length (mm)		140	-
Height mounted on TH35/7,5 (mm)		113	-
Height mounted on TH35/15 (mm)		120	-
Height mounted on G32 (mm)		117	-
Height panel mount (mm)		-	108
Length panel mount (mm)		-	173
Fixing distance between centres (mm)		-	158
Insulation material temperature index (EN 60216-1) (°C)		130	130
Plastic material		Polyamide UL94 V0	Polyamide UL94 V0

APPROVALS



ACCESSORIES			
Permanent cross connection	(1)	POF/95/... (cod. P095...)	POF/95/... (cod. P095...)
	Rated current (A)	-	-
Mounting rail support	flat for PR/DIN e PR/3	ACI121213 (cod. Z121213)	ACI121213 (cod. Z121213)
	sloped for PR/DIN e PR/3	ACI121024 (cod. Z121024)	ACI121024 (cod. Z121024)
Marking tag		CNU/08/51 (cod. NU0851S)	CNU/08/51 (cod. NU0851S)
		CNU/10/61 (cod. NU1061S)	CNU/10/61 (cod. NU1061S)
End bracket	Snap-fit TH35 and G32	BTU (cod. BT005)	BTU (cod. BT005)
	Snap-fit TH35	BTO (cod. BT007)	BTO (cod. BT007)
	Screw TH35	BT/3 (cod. BT003)	BT/3 (cod. BT003)

SCREW CLAMP

- panel mount version - M6 screws (recommended with screwdriver and washer slot)
- possibility of parallel cross connection

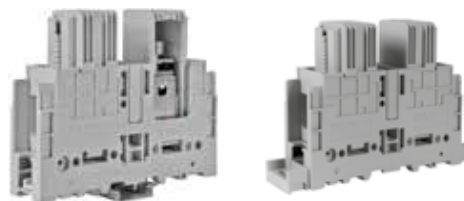

CESI 13 ATEX 038 U
I M2 Ex e I Mb
II 2 G Ex e IIC Gb

IECEX CES 13.0012U
Ex e I Mb
Ex e IIC Gb

(1) See chapter accessories for more details

BEIGE VERSION	CODE TYPE	GP600	GP610
		GPM.150/CC	GPM.150/CC/FIX
GREY VERSION	CODE TYPE	GP600GR	GP610GR
		GPM.150/CC/GR	GPM.150/CC/FIX/GR

TECHNICAL CHARACTERISTICS

Function/type		feed-through	feed-through
Rated cross-section	(mm ²)	150	150
Connecting capacity	Flexible (mm ²)	50 ÷ 150	50 ÷ 150
	Rigid (mm ²)	35 ÷ 185	35 ÷ 185
Bars and/or cable lugs	Maximum width / bolt (mm)	-	-
Electrical characteristics According to European standard IEC EN 60947-7-1	Max AC/DC Voltage (V)	1000	1000
	Max current with rated cross-section (A)	309	309
	Max current with Max cross-section (A)	440	440
	Section (Caliber)	B14	B14
Electrical characteristics According to ATEX directive and IEC ex standard	Max AC/DC Voltage (V)	1000	1000
	Max current with rated cross-section (A)	309	309
	Operating Temperature (°C)	-40 ÷ +80	-40 ÷ +80
Rated impulse withstand voltage/pollution degree		12 KV / 3	12 KV / 3
Insulation stripping length (mm)		35	35
Tightening torque nominal/max	Bar (Nm)	-	-
	Cable (Nm)	10 / 15	10 / 15
Width (mm)		42	42
Length (mm)		140	-
Height mounted on TH35/7,5 (mm)		134	-
Height mounted on TH35/15 (mm)		141	-
Height mounted on G32 (mm)		138	-
Height panel mount (mm)		-	129
Length panel mount (mm)		-	173
Fixing distance between centres (mm)		-	158
Insulation material temperature index (EN 60216-1) (°C)		130	130
Plastic material		Polyamide UL94 V0	Polyamide UL94 V0

APPROVALS



ACCESSORIES			
Permanent cross connection	(1)	PFX/150/... (cod. PX15...)	PFX/150/... (cod. PX15...)
	Rated current (A)	-	-
Mounting rail support	flat for PR/DIN e PR/3	ACI121213 (cod. Z121213)	ACI121213 (cod. Z121213)
	sloped for PR/DIN e PR/3	ACI121024 (cod. Z121024)	ACI121024 (cod. Z121024)
Marking tag		CNU/08/51 (cod. NU0851S)	CNU/08/51 (cod. NU0851S)
		CNU/10/61 (cod. NU1061S)	CNU/10/61 (cod. NU1061S)
End bracket	Snap-fit TH35 and G32	BTU (cod. BT005)	BTU (cod. BT005)
	Snap-fit TH35	BTO (cod. BT007)	BTO (cod. BT007)
	Screw TH35	BT/3 (cod. BT003)	BT/3 (cod. BT003)

SCREW CLAMP

- panel mount version - M6 screws (recommended with screwdriver and washer slot)
- possibility of parallel cross connection

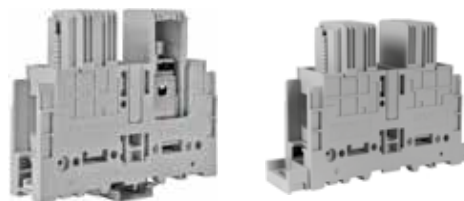

CESI 13 ATEX 038 U
I M2 Ex e I Mb
II 2 G Ex e IIC Gb

IECEx CES 13.0012U
Ex e I Mb
Ex e IIC Gb

(1) See chapter accessories for more details

BEIGE VERSION	CODE TYPE	GP900	GP910
		GPM.240/CC	GPM.240/CC/FIX
GREY VERSION	CODE TYPE	GP900GR	GP910GR
		GPM.240/CC/GR	GPM.240/CC/FIX/GR

TECHNICAL CHARACTERISTICS

Function/type		feed-through	feed-through
Rated cross-section	(mm ²)	240	240
Connecting capacity	Flexible (mm ²)	95 ÷ 240	95 ÷ 240
	Rigid (mm ²)	50 ÷ 300	50 ÷ 300
Bars and/or cable lugs	Maximum width / bolt (mm)	-	-
Electrical characteristics According to European standard IEC EN 60947-7-1	Max AC/DC Voltage (V)	1000	1000
	Max current with rated cross-section (A)	415	415
	Max current with Max cross-section (A)	600	600
	Section (Caliber)	B16	B16
Electrical characteristics According to ATEX directive and IEC ex standard	Max AC/DC Voltage (V)	1000	1000
	Max current with rated cross-section (A)	415	415
	Operating Temperature (°C)	-40 ÷ +80	-40 ÷ +80
Rated impulse withstand voltage/pollution degree		12 KV / 3	12 KV / 3
Insulation stripping length (mm)		43	43
Tightening torque nominal/max	Bar (Nm)	-	-
	Cable (Nm)	14 / 21	14 / 21
Width (mm)		52	52
Length (mm)		154	-
Height mounted on TH35/7,5 (mm)		150	-
Height mounted on TH35/15 (mm)		157	-
Height mounted on G32 (mm)		154	-
Height panel mount (mm)		-	144
Length panel mount (mm)		-	187
Fixing distance between centres (mm)		-	172
Insulation material temperature index (EN 60216-1) (°C)		130	130
Plastic material		Polyamide UL94 V0	Polyamide UL94 V0

APPROVALS



ACCESSORIES			
Permanent cross connection	(1)	PFX/240/... (cod. PX24...)	PFX/240/... (cod. PX24...)
	Rated current (A)	-	-
Mounting rail support	flat for PR/DIN e PR/3	ACI121213 (cod. Z121213)	ACI121213 (cod. Z121213)
	sloped for PR/DIN e PR/3	ACI121024 (cod. Z121024)	ACI121024 (cod. Z121024)
Marking tag		CNU/08/51 (cod. NU0851S)	CNU/08/51 (cod. NU0851S)
		CNU/10/61 (cod. NU1061S)	CNU/10/61 (cod. NU1061S)
End bracket	Snap-fit TH35 and G32	BTU (cod. BT005)	BTU (cod. BT005)
	Snap-fit TH35	BTO (cod. BT007)	BTO (cod. BT007)
	Screw TH35	BT/3 (cod. BT003)	BT/3 (cod. BT003)

SCREW CLAMP

- panel mount version - M6 screws (recommended with screwdriver and washer slot)
- possibility of parallel cross connection



(1) See chapter accessories for more details

BEIGE VERSION WITH COVER	CODE TYPE	GP125	GP135	GP425
		GPM.95/C/BB	GPM.95/C/BB/FIX	GPM.150/C/BB
BEIGE VERSION WITHOUT COVER	CODE TYPE	GP120	GP130	GP420
		GPM.95/O/BB	GPM.95/O/BB/FIX	GPM.150/O/BB

TECHNICAL CHARACTERISTICS

Function/type		feed-through	feed-through	feed-through
Rated cross-section	(mm ²)	95	95	150
Connecting capacity	Flexible (mm ²)	-	-	-
	Rigid (mm ²)	-	-	-
Bars and/or cable lugs	Maximum width / bolt (mm)	22 / M8	22 / M8	32 / M10
	Max AC/DC Voltage (V)	1000	1000	1000
Electrical characteristics According to European standard IEC EN 60947-7-1	Max current with rated cross-section (A)	232	232	309
	Max current with Max cross-section (A)	248	248	365
	Section (Caliber)	-	-	-
Electrical characteristics According to ATEX directive and IEC ex standard	Max AC/DC Voltage (V)	-	-	-
	Max current with rated cross-section (A)	-	-	-
	Operating Temperature (°C)	-	-	-
Rated impulse withstand voltage/pollution degree		12 KV / 3	12 KV / 3	12 KV / 3
Insulation stripping length (mm)		-	-	-
Tightening torque nominal/max	Bar (Nm)	6 / 9	6 / 9	10 / 15
	Cable (Nm)	-	-	-
Width (mm)		32	32	42
Length (mm)		176	-	200
Height mounted on TH35/7,5 (mm)		81	-	81
Height mounted on TH35/15 (mm)		88	-	88
Height mounted on G32 (mm)		85	-	85
Height panel mount (mm)		-	76	-
Length panel mount (mm)		-	176	-
Fixing distance between centres (mm)		-	158	-
Insulation material temperature index (EN 60216-1) (°C)		130	130	130
Plastic material		Polyamide UL94 V0	Polyamide UL94 V0	Polyamide UL94 V0

APPROVALS



ACCESSORIES				
Permanent cross connection	(1)	POF/95/... (cod. P095...)	POF/95/... (cod. P095...)	PFX/150/... (cod. PX15...)
	Rated current (A)	-	-	-
Mounting rail support	flat for PR/DIN e PR/3	ACI121213 (cod. Z121213)	ACI121213 (cod. Z121213)	ACI121213 (cod. Z121213)
	sloped for PR/DIN e PR/3	ACI121024 (cod. Z121024)	ACI121024 (cod. Z121024)	ACI121024 (cod. Z121024)
Marking tag		CNU/08/51 (cod. NU0851S)	CNU/08/51 (cod. NU0851S)	CNU/08/51 (cod. NU0851S)
		CNU/10/61 (cod. NU1061S)	CNU/10/61 (cod. NU1061S)	CNU/10/61 (cod. NU1061S)
End bracket	Snap-fit TH35 and G32	BTU (cod. BT005)	BTU (cod. BT005)	BTU (cod. BT005)
	Snap-fit TH35	BTO (cod. BT007)	BTO (cod. BT007)	BTO (cod. BT007)
	Screw TH35	BT/3 (cod. BT003)	BT/3 (cod. BT003)	BT/3 (cod. BT003)

- panel mount version - M6 screws (recommended with screwdriver and washer slot)
- possibility of parallel cross connection



(1) See chapter accessories for more details

BEIGE VERSION WITH COVER	CODE TYPE	GP435	GP725	GP735
		GPM.150/C/BB/FIX	GPM.240/C/BB	GPM.240/C/BB/FIX
BEIGE VERSION WITHOUT COVER	CODE TYPE	GP430	GP720	GP730
		GPM.150/O/BB/FIX	GPM.240/O/BB	GPM.240/O/BB/FIX

TECHNICAL CHARACTERISTICS

Function/type		feed-through	feed-through	feed-through
Rated cross-section	(mm ²)	150	240	240
Connecting capacity	Flexible (mm ²)	-	-	-
	Rigid (mm ²)	-	-	-
Bars and/or cable lugs	Maximum width / bolt (mm)	32 / M10	40 / M12	40 / M12
	Max AC/DC Voltage (V)	1000	1000	1000
Electrical characteristics According to European standard IEC EN 60947-7-1	Max current with rated cross-section (A)	309	415	415
	Max current with Max cross-section (A)	365	530	530
	Section (Caliber)	-	-	-
Electrical characteristics According to ATEX directive and IEC ex standard	Max AC/DC Voltage (V)	-	-	-
	Max current with rated cross-section (A)	-	-	-
	Operating Temperature (°C)	-	-	-
Rated impulse withstand voltage/pollution degree		12 KV / 3	12 KV / 3	12 KV / 3
Insulation stripping length (mm)		-	-	-
Tightening torque nominal/max	Bar (Nm)	10 / 15	14 / 21	14 / 21
	Cable (Nm)	-	-	-
Width (mm)		42	52	52
Length (mm)		-	250	-
Height mounted on TH35/7,5 (mm)		-	89	-
Height mounted on TH35/15 (mm)		-	96	-
Height mounted on G32 (mm)		-	93	-
Height panel mount (mm)		76	-	84
Length panel mount (mm)		200	-	250
Fixing distance between centres (mm)		158	-	172
Insulation material temperature index (EN 60216-1) (°C)		130	130	130
Plastic material		Polyamide UL94 V0	Polyamide UL94 V0	Polyamide UL94 V0

APPROVALS



ACCESSORIES				
Permanent cross connection	(1)	PFX/150/... (cod. PX15...)	PFX/240/... (cod. PX24...)	PFX/240/... (cod. PX24...)
	Rated current (A)	-	-	-
Mounting rail support	flat for PR/DIN e PR/3	ACI121213 (cod. Z121213)	ACI121213 (cod. Z121213)	ACI121213 (cod. Z121213)
	sloped for PR/DIN e PR/3	ACI121024 (cod. Z121024)	ACI121024 (cod. Z121024)	ACI121024 (cod. Z121024)
Marking tag		CNU/08/51 (cod. NU0851S)	CNU/08/51 (cod. NU0851S)	CNU/08/51 (cod. NU0851S)
		CNU/10/61 (cod. NU1061S)	CNU/10/61 (cod. NU1061S)	CNU/10/61 (cod. NU1061S)
End bracket	Snap-fit TH35 and G32	BTU (cod. BT005)	BTU (cod. BT005)	BTU (cod. BT005)
	Snap-fit TH35	BTO (cod. BT007)	BTO (cod. BT007)	BTO (cod. BT007)
	Screw TH35	BT/3 (cod. BT003)	BT/3 (cod. BT003)	BT/3 (cod. BT003)

SCREW CLAMP

• bar - bar terminal blocks



Due to the non-standardized thickness of the terminals, for the use of the conductors of the smaller connectable sections, it may be necessary to introduce a washer under the screw head.

BEIGE VERSION	AC100	AC400	AC700
	ACB.70/BB	ACB.120/BB	ACB.185/BB
TECHNICAL CHARACTERISTICS			
Function/type	feed-through	feed-through	feed-through
Rated cross-section [mm ²]	70	120	185
Connecting capacity	Flexible [mm ²]	10 ÷ 120	25 ÷ 185
	Rigid [mm ²]	6 ÷ 120	25 ÷ 185
Bars and/or cable lugs	Maximum width / bolt [mm]	25 / M6	25 / M8
	Max AC/DC Voltage [V]	800	800
Electrical characteristics According to European standard IEC EN 60947-7-1	Max current with rated cross-section [A]	192	269
	Section Caliber	-	-
Rated impulse withstand voltage/pollution degree	8 KV / 3	8 KV / 3	8 KV / 3
Tightening torque nominal/max [Nm]	3 (key 10 mm)	6 (key 13 mm)	14 (key 19 mm)
Width [mm]	35	35	35
Length [mm]	90	100	120
Height mounted on TH35/7,5 [mm]	-	-	-
Height mounted on TH35/15 [mm]	-	-	-
Height mounted on G32 [mm]	45	46	47
Insulation material temperature index (EN 60216-1) [°C]	130	130	130
Plastic material	Polyamide UL94 V0	Polyamide UL94 V0	Polyamide UL94 V0
APPROVALS			
ACCESSORIES			
Safety cover	PRT/P (cod. PRT01)	PRT/P (cod. PRT01)	PRT/P (cod. PRT01)
	PRT/G (cod. PRT03)	PRT/G (cod. PRT03)	PRT/G (cod. PRT03)
Cover support	SPS/1 (cod. SPS01)	SPS/1 (cod. SPS01)	SPS/1 (cod. SPS01)
Marking tag	CNU/08/51 (cod. NU0851S)	CNU/08/51 (cod. NU0851S)	CNU/08/51 (cod. NU0851S)
	CNU/10/61 (cod. NU1061S)	CNU/10/61 (cod. NU1061S)	CNU/10/61 (cod. NU1061S)
End bracket	BTU (cod. BT005)	BTU (cod. BT005)	BTU (cod. BT005)

Protection: ACB terminal blocks can be protected against direct and/or accidental contacts by means of specific **PRT** covers of different sizes: Small, Medium or Large in transparent and self-extinguishing material. These covers, with a fixed length of 200 mm, correspond to the width of four terminal blocks side-by-side and inserted on **SPS** supports, also made of self-extinguishing material, which enable the protection of one of the two connections of the terminal blocks; the complete protection of the terminal board is obtained using two covers, overlappable.

The **PRT/G** is to be used when the conductors come from the backboard, or in order to protect a connection point not yet connected.

PRT/P+SPS/1	PRT/P+SPS/3
for ACB.70/BB, ACB.120/BB, BCA.70 and BCA 120 terminal blocks	for ACB.185/BB, BCA.70 and BCA 120 terminal blocks



- bar - bar terminal blocks



Due to the non-standardized thickness of the terminals, for the use of the conductors of the smaller connectable sections, it may be necessary to introduce a washer under the screw head.

BEIGE VERSION	BC100	BC400
	BCA.70/BB	BCA.120/BB
TECHNICAL CHARACTERISTICS		
Function/type	feed-through	feed-through
Rated cross-section	(mm ²) 70	120
Connecting capacity	Flexible (mm ²) 10 ÷ 120	25 ÷ 185
	Rigid (mm ²) 6 ÷ 120	25 ÷ 185
Bars and/or cable lugs	Maximum width / bolt (mm) 25 / M6	25 / M8
Electrical characteristics	Max AC/DC Voltage (V) 800	800
	Max current with rated cross-section (A) 192	269
According to European standard IEC EN 60947-7-1	Section Caliber -	-
Rated impulse withstand voltage/pollution degree	3kV / 3	3kV / 3
Tightening torque nominal/max	(Nm) 3 (key 10 mm)	6 (key 13 mm)
Width	(mm) 35	35
Length	(mm) 90	100
Height mounted on G32	(mm) 41	42
Height mounted on TH35/7,5	(mm) 49	50
Height mounted on TH35/15	(mm) -	-
Insulation material temperature index (EN 60216-1)	(°C) 130	130
Plastic material	Polyamide UL94 V0	Polyamide UL94 V0
APPROVALS		
ACCESSORIES		
Safety cover	PRT/P (cod. PRT01) PRT/G (cod. PRT03)	PRT/P (cod. PRT01) PRT/G (cod. PRT03)
Cover support	SPS/1 (cod. SPS01)	SPS/1 (cod. SPS01)
Marking tag	CNU/08/51 (cod. NU0851S)	CNU/08/51 (cod. NU0851S)
	CNU/10/61 (cod. NU1061S)	CNU/10/61 (cod. NU1061S)
End bracket	BTU (cod. BT005)	BTU (cod. BT005)

- stud connection, for cable lugs



BEIGE VERSION

MB100

MBL.50/6

MB200

MBL.95/8

TECHNICAL CHARACTERISTICS

Function/type		for cable lugs	for cable lugs
Rated cross-section	(mm ²)	50	95
Connecting capacity	Flexible	30 ÷ 50	30 ÷ 95
	Rigid	30 ÷ 70	30 ÷ 120
Stud diameter / key / locking bolt wrench		M6 / 10mm / 19mm	M8 / 13mm / 19mm
Electrical characteristics According to European standard IEC EN 60947-7-1	Max AC/DC Voltage	(V) 800	800
	Max current with rated cross-section	(A) 150	232
	Section	Caliber -	-
Electrical characteristics According to UL	Max AC/DC Voltage	(V) 600	600
	Max current with rated cross-section	(A) 150	200
	Section Min - Max	(AWG) -	-
Rated impulse withstand voltage/pollution degree		8kV / 3	8 kV / 3
Maximum connectable width	(mm)	30	30
Max lug overlapping connection height	(mm)	15.3	13
Tightening torque	(Nm)	3	6
Width	(mm)	35	35
Length	(mm)	40	40
Height mounted on G32	(mm)	79	79
Insulation material temperature index (EN 60216-1)	(°C)	130	130
Plastic material		polyamide UL94V-0	polyamide UL94V-0

APPROVALS



ACCESSORIES

Partition		DUS/1 (cod. DUS01)	DUS/1 (cod. DUS01)
Cover support		SPS/5 (cod. SPS05)	SPS/5 (cod. SPS05)
Safety cover		PRT/P (cod. PRT01)	PRT/P (cod. PRT01)
Marking tag		CNU/08/51 (cod. NU0851S)	CNU/08/51 (cod. NU0851S)
		CNU/10/61 (cod. NU1061S)	CNU/10/61 (cod. NU1061S)
End bracket	Snap-fit TH35 e G32	BTU (cod. BT005)	BTU (cod. BT005)

Stud terminal blocks for the terminal wire or bar strain clamp with max. width 30 mm, to be mounted on PR/DIN mounting rail. It is advisable to use **DUS/1** or **DUS/3** barriers to guarantee the insulation distance between different phases.

If accident prevention cover of the terminal board becomes necessary, the insulation function would be performed by the **SPS/5** supports of the cover itself.



- stud connection, for cable lugs



BEIGE VERSION	MB300 MBL.120/10	MB400 MBL.150/12
---------------	---------------------	---------------------

TECHNICAL CHARACTERISTICS

Function/type		for cable lugs	for cable lugs
Rated cross-section	(mm ²)	120	150
Connecting capacity	Flexible (mm ²)	30 ÷ 120	30 ÷ 150
	Rigid (mm ²)	30 ÷ 150	30 ÷ 185
Stud diameter / key / locking bolt wrench		M10 / 17mm / 19mm	M12 / 19mm / 19mm
Electrical characteristics According to European standard IEC EN 60947-7-1	Max AC/DC Voltage (V)	800	800
	Max current with rated cross-section (A)	269	309
	Section Caliber	-	-
Electrical characteristics According to UL	Max AC/DC Voltage (V)	600	600
	Max current with rated cross-section (A)	230	285
	Section Min - Max (AWG)	-	-
Rated impulse withstand voltage/pollution degree		8 kV / 3	8 kV / 3
Maximum connectable width (mm)		30	30
Max lug overlapping connection height (mm)		13	15.8
Tightening torque (Nm)		10	14
Width (mm)		35	35
Length (mm)		40	40
Height mounted on G32 (mm)		90	90
Insulation material temperature index (EN 60216-1) (°C)		130	130
Plastic material		polyamide UL94V-0	polyamide UL94V-0

APPROVALS



ACCESSORIES		
Partition		DUS/3 (cod. DUS03)
Cover support		SPS/5 (cod. SPS05)
Safety cover		PRT/P (cod. PRT01)
Marking tag		CNU/08/51 (cod. NU0851S)
		CNU/10/61 (cod. NU1061S)
End bracket	Snap-fit TH35 e G32	BTU (cod. BT005)



Ex CESI 02 ATEX 061 U
I M2 Ex eb I Mb
II 2 G Ex eb IIC Gb

IECEx CES 09.0010U
Ex eb I Mb
Ex eb IIC Gb

YELLOW/GREEN VERSION		CODE	TO910	CE110	TO430
		TYPE	TE0.2	CBE.2	TE0.4
TECHNICAL CHARACTERISTICS					
Function/type			Earth terminal block	Earth terminal block	Earth terminal block
Rated cross-section		[mm ²]	2,5	2,5	4
Connecting capacity	Flexible	[mm ²]	0.2 - 4	0.2 - 4	0.2 - 6
	Rigid	[mm ²]	0.2 - 4	0.2 - 4	0.2 - 6
	Max. flexible with ferrule - ferrule type	[mm ²]	2.5 - WP25/14	2.5 - WP25/14	4 - WP40/16
Electrical characteristics According to European standard IEC EN 60947-7-2	Max AC/DC Voltage	[V]	-	-	-
	Max current with rated cross-section	[A]	-	-	-
Electrical characteristics According to UL	Section	Caliber	A3	A3	A4
	Max AC/DC Voltage	[V]	-	-	-
	Max current with rated cross-section	[A]	-	-	-
Electrical characteristics According to ATEX directive and IEC ex standard	Section Min - Max	[AWG]	20 - 14	20 - 14	20 - 12
	Tightening torque	[lb.in]	5.5	5.5	5.5
	Max AC/DC Voltage	[V]	-	-	-
Rated impulse withstand voltage/pollution degree	Max current with rated cross-section	[A]	24	-	32
	Operating Temperature	[°C]	-40 ÷ +110	-	-40 ÷ +110
Rated impulse withstand voltage/pollution degree			8 KV / 3	8 KV / 3	8 KV / 3
Insulation stripping length		[mm]	12	8	14
Tightening torque value Nominal / Max		[Nm]	0.4 / 0.8	0.4 / 0.5	0.5 / 1.2
Length		[mm]	50	50	50
Width		[mm]	5.5	5	6.5
Height mounted on TH35/7.5		[mm]	47	52	52
Height mounted on TH35/15		[mm]	55	60	60
Height mounted on G32		[mm]	-	56	-
Insulation material temperature index [EN 60216-1]		[°C]	130	130	130
Plastic material			Polyamide UL94V-0	Polyamide UL94V-0	Polyamide UL94V-0
APPROVALS					
ACCESSORIES					
End section		green	TE0.2/PT (cod. TO911)	CBR/PT (cod. CR111)	TE0.4/PT (cod. TO431)
Numbering strip			-	CNU/08/51 (cod. NU0851S)	-
Marking tag			CNU/08/51 (cod. NU0851S)	CNU/08/51 (cod. NU0851S)	CNU/08/51 (cod. NU0851S)
			CNU/10/61 (cod. NU1061S)	CNU/10/61 (cod. NU1061S)	CNU/10/61 (cod. NU1061S)
End bracket		Snap-fit TH35 e G32	BT/3 (cod. BT003)	BT/3 (cod. BT003)	BT/3 (cod. BT003)
		Snap-fit TH35	BTO (cod. BT007)	BTO (cod. BT007)	BTO (cod. BT007)
		Screw TH35	BTU (cod. BT005)	BTU (cod. BT005)	BTU (cod. BT005)
		Screw G32	-	BT/DIN/PO (cod. BT001)	-

MAXIMUM SHORT-TIME WITHSTAND CURRENTS ALLOCATED TO THE RAIL PROFILE

Rail profile	Material	Equivalent E-Cu cross-section mm ²	Short-time withstand current 1 s kA	Thermal rated current of a PEN busbar A
Top hat rail IEC 60715/TH 15 - 5.5	Steel	10	1.2	-
	Copper	25	3	101
	Aluminium	16	1.92	76
Top hat rail IEC 60715/TH 35 - 7.5	Steel	16	1.92	-
	Copper	50	6	150
	Aluminium	35	4.2	125
Top hat rail IEC 60715/TH 35 - 15	Steel	50	6	-
	Copper	150	18	309
	Aluminium	95	11.4	232



CESI 02 ATEX 061 U
I M2 Ex eb I Mb
II 2 G Ex eb IIC Gb

IECEx CES 09.0010U
Ex eb I Mb
Ex eb IIC Gb



YELLOW/GREEN VERSION		CODE	TE400	T0110	T0500
		TYPE	TED.4	TE.6/0	TE.10/0
TECHNICAL CHARACTERISTICS					
Function/type			Earth terminal block	Earth terminal block	Earth terminal block
Rated cross-section			4	6	10
Connecting capacity	Flexible	[mm ²]	0.2 - 6	0.5 - 10	0.5 - 16
	Rigid	[mm ²]	0.2 - 6	0.5 - 10	0.5 - 16
	Max. flexible with ferrule - ferrule type	[mm ²]	4 - WP40/16	6 - WP60/20	10 - WP100/21
Electrical characteristics According to European standard IEC EN 60947-7-2	Max AC/DC Voltage	[V]	-	-	-
	Max current with rated cross-section	[A]	-	-	-
	Section	Caliber	A4	A5	B6
Electrical characteristics According to UL	Max AC/DC Voltage	[V]	-	-	-
	Max current with rated cross-section	[A]	-	-	-
	Section Min - Max	[AWG]	20 - 12	20 - 8	20 - 8
	Tightening torque	[lb.in]	5.5	13.3	13.3
Electrical characteristics According to ATEX directive and IEC ex standard	Max AC/DC Voltage	[V]	-	-	-
	Max current with rated cross-section	[A]	-	41	57
	Operating Temperature	[°C]	-40 ÷ +80	-40 ÷ +110	-40 ÷ +110
Rated impulse withstand voltage/pollution degree			8 KV / 3	8 KV / 3	8 KV / 3
Insulation stripping length			10	12	13
Tightening torque value Nominal / Max			0.5 / 1.2	0.8 / 1.4	1.2 / 1.9
Length			50	47	47
Width			6.5	8	10
Height mounted on TH35/7.5			-	52	55
Height mounted on TH35/15			-	60	63
Height mounted on G32			56	-	-
Insulation material temperature index [EN 60216-1]			130	130	130
Plastic material			Polyamide UL94V-0	Polyamide UL94V-0	Polyamide UL94V-0
APPROVALS					
ACCESSORIES					
End section			TEO.4/PT (cod. T0431)	-	-
Numbering strip			-	-	-
Marking tag			CNU/08/51 (cod. NU0851S)	CNU/08/51 (cod. NU0851S)	CNU/08/51 (cod. NU0851S)
			CNU/10/61 (cod. NU1061S)	CNU/10/61 (cod. NU1061S)	CNU/10/61 (cod. NU1061S)
End bracket			Snap-fit TH35 e G32	BT/3 (cod. BT003)	BT/3 (cod. BT003)
			Snap-fit TH35	BTO (cod. BT007)	BTO (cod. BT007)
			Screw TH35	BTU (cod. BT005)	BTU (cod. BT005)
			Screw G32	BT/DIN/PO (cod. BT001)	-

MAXIMUM SHORT-TIME WITHSTAND CURRENTS ALLOCATED TO THE RAIL PROFILE

Rail profile	Material	Equivalent E-Cu cross-section mm ²	Short-time withstand current 1s kA	Thermal rated current of a PEN busbar A
Top hat rail IEC 60715/TH 15 - 5.5	Steel	10	1.2	-
	Copper	25	3	101
	Aluminium	16	1.92	76
Top hat rail IEC 60715/TH 35 - 7.5	Steel	16	1.92	-
	Copper	50	6	150
	Aluminium	35	4.2	125
Top hat rail IEC 60715/TH 35 - 15	Steel	50	6	-
	Copper	150	18	309
	Aluminium	95	11.4	232



CESI 02 ATEX 061 U
I M2 Ex eb I Mb
II 2 G Ex eb IIC Gb

IECEx CES 09.0010U
Ex eb I Mb
Ex eb IIC Gb



YELLOW/GREEN VERSION		CODE	TO210	TO310	TE110
		TYPE	TE.16/O	TE.50/O	TE.6/D
TECHNICAL CHARACTERISTICS					
Function/type			Earth terminal block	Earth terminal block	Earth terminal block
Rated cross-section			[mm ²]	[mm ²]	[mm ²]
Connecting capacity			[mm ²]	[mm ²]	[mm ²]
			Flexible	1.5 - 50	0.5 - 10
			Rigid	1 - 70	0.5 - 10
			Max. flexible with ferrule - ferrule type	50 - WP500/40	6 - WP60/20
Electrical characteristics According to European standard IEC EN 60947-7-2			[V]	-	-
			Max AC/DC Voltage	-	-
			Max current with rated cross-section	-	-
			Section	B7	A5
			Caliber	B9	A5
Electrical characteristics According to UL			[V]	-	-
			Max AC/DC Voltage	-	-
			Max current with rated cross-section	-	-
			Section Min - Max	16 - 1	20 - 8
			[AWG]	33.2	13.3
			Tightening torque	-	-
			[lb.in]	-	-
Electrical characteristics According to ATEX directive and IEC ex standard			[V]	-	-
			Max AC/DC Voltage	-	-
			Max current with rated cross-section	76	41
			[A]	150	41
			Operating Temperature	-40 ÷ +110	-40 ÷ +110
			[°C]	-40 ÷ +110	-40 ÷ +110
Rated impulse withstand voltage/pollution degree			8 kV / 3	8 kV / 3	8 kV / 3
Insulation stripping length			[mm]	13	12
Tightening torque value Nominal / Max			[Nm]	1.8 / 3	2.5 / 5
Length			[mm]	47	57
Width			[mm]	12	18
Height mounted on TH35/7.5			[mm]	56	62
Height mounted on TH35/15			[mm]	64	70
Height mounted on G32			[mm]	-	-
Insulation material temperature index [EN 60216-1]			[°C]	130	130
Plastic material			Polyamide UL94V-0	Polyamide UL94V-0	Polyamide UL94V-0
APPROVALS					
ACCESSORIES					
End section			green	-	-
Numbering strip			-	-	-
Marking tag			CNU/08/51 (cod. NU0851S) CNU/10/61 (cod. NU1061S)	CNU/08/51 (cod. NU0851S) CNU/10/61 (cod. NU1061S)	CNU/08/51 (cod. NU0851S) CNU/10/61 (cod. NU1061S)
End bracket			Snap-fit TH35 e G32 Snap-fit TH35 Screw TH35 Screw G32	BT/3 (cod. BT003) BTO (cod. BT007) BTU (cod. BT005) -	BT/3 (cod. BT003) BTO (cod. BT007) BTU (cod. BT005) BT/DIN/PO (cod. BT001)

MAXIMUM SHORT-TIME WITHSTAND CURRENTS ALLOCATED TO THE RAIL PROFILE

Rail profile	Material	Equivalent E-Cu cross-section mm ²	Short-time withstand current 1 s kA	Thermal rated current of a PEN busbar A
Top hat rail IEC 60715/TH 15 - 5.5	Steel	10	1.2	-
	Copper	25	3	101
	Aluminium	16	1.92	76
G32 type mounting rail IEC 60715/G32	Steel	35	4.2	-
	Copper	120	14.4	269
	Aluminium	70	8.4	192
Top hat rail IEC 60715/TH 35 - 7.5	Steel	16	1.92	-
	Copper	50	6	150
	Aluminium	35	4.2	125
Top hat rail IEC 60715/TH 35 - 15	Steel	50	6	-
	Copper	150	18	309
	Aluminium	95	11.4	232



CESI 02 ATEX 061 U
I M2 Ex eb I Mb
II 2 G Ex eb IIC Gb

IECEx CES 09.0010U
Ex eb I Mb
Ex eb IIC Gb



YELLOW/GREEN VERSION		CODE	TE500	TE210	TE310
		TYPE	TE.10/D	TE.16/D	TE.50/D
TECHNICAL CHARACTERISTICS					
Function/type			Earth terminal block	Earth terminal block	Earth terminal block
Rated cross-section			10	16	50
Connecting capacity	Flexible	[mm ²]	0.5 - 16	0.5 - 25	1.5 - 50
	Rigid	[mm ²]	0.5 - 16	0.5 - 25	1 - 70
	Max. flexible with ferrule - ferrule type	[mm ²]	10 - WP100/21	16 - WP160/22	50 - WP500/40
Electrical characteristics According to European standard IEC EN 60947-7-2	Max AC/DC Voltage	[V]	-	-	-
	Max current with rated cross-section	[A]	-	-	-
	Section	Caliber	B6	B7	B9
Electrical characteristics According to UL	Max AC/DC Voltage	[V]	-	-	-
	Max current with rated cross-section	[A]	-	-	-
	Section Min - Max	[AWG]	20 - 8	20 - 3	16 - 1
	Tightening torque	[lb.in]	13.3	13.3	33.2
Electrical characteristics According to ATEX directive and IEC ex standard	Max AC/DC Voltage	[V]	-	-	-
	Max current with rated cross-section	[A]	57	76	150
Operating Temperature			[°C]	-40 ÷ +110	-40 ÷ +110
Rated impulse withstand voltage/pollution degree			8 KV / 3	8 KV / 3	8 KV / 3
Insulation stripping length			[mm]	13	17
Tightening torque value Nominal / Max			[Nm]	1.2 / 1.9	2.5 / 5
Length			[mm]	44	57
Width			[mm]	10	18
Height mounted on TH35/7.5			[mm]	-	-
Height mounted on TH35/15			[mm]	-	-
Height mounted on G32			[mm]	56	63
Insulation material temperature index [EN 60216-1]			[°C]	130	130
Plastic material			Polyamide UL94V-0	Polyamide UL94V-0	Polyamide UL94V-0
APPROVALS					
ACCESSORIES					
End section			green	-	-
Numbering strip			-	-	-
Marking tag			CNU/08/51 (cod. NU0851S) CNU/10/61 (cod. NU1061S)	CNU/08/51 (cod. NU0851S) CNU/10/61 (cod. NU1061S)	CNU/08/51 (cod. NU0851S) CNU/10/61 (cod. NU1061S)
End bracket	Snap-fit TH35 e G32		BT/3 (cod. BT003)	BT/3 (cod. BT003)	BT/3 (cod. BT003)
	Snap-fit TH35		BTO (cod. BT007)	BTO (cod. BT007)	BTO (cod. BT007)
	Screw TH35		BTU (cod. BT005)	BTU (cod. BT005)	BTU (cod. BT005)
	Screw G32		BT/DIN/PO (cod. BT001)	BT/DIN/PO (cod. BT001)	BT/DIN/PO (cod. BT001)

MAXIMUM SHORT-TIME WITHSTAND CURRENTS ALLOCATED TO THE RAIL PROFILE

Rail profile	Material	Equivalent E-Cu cross-section mm ²	Short-time withstand current 1s kA	Thermal rated current of a PEN busbar A
Top hat rail IEC 60715/TH 15 - 5.5	Steel	10	1.2	-
	Copper	25	3	101
	Aluminium	16	1.92	76
G32 type mounting rail IEC 60715/G32	Steel	35	4.2	-
	Copper	120	14.4	269
	Aluminium	70	8.4	192
Top hat rail IEC 60715/TH 35 - 7.5	Steel	16	1.92	-
	Copper	50	6	150
	Aluminium	35	4.2	125
Top hat rail IEC 60715/TH 35 - 5.5	Steel	50	6	-
	Copper	150	18	309
	Aluminium	95	11.4	232



CESI 14 ATEX 035 U
I M2 Ex e I Mb
II 2 G Ex e IIC Gb

IECEx CES 14.0021U
Ex e I Mb
Ex e IIC Gb

(1) See chapter accessories for more details

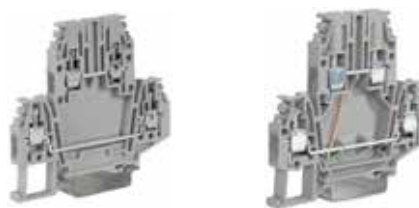

GREY VERSION	CODE	DB100GR	DBC.2/GR	DB117GR	DBC.2/CI/GR
	TYPE				
BEIGE VERSION	CODE	DB100		DB117	
	TYPE		DBC.2		DBC.2/CI
BLUE VERSION	CODE	DB200			
	TYPE		DBC.2 (EX)I		

TECHNICAL CHARACTERISTICS

Function/type		2 levels	2 levels with internal connection
Rated cross-section	(mm ²)	2.5	2.5
Connecting capacity	Flexible (mm ²)	0.2 - 4	0.2 - 4
	Rigid (mm ²)	0.2 - 4	0.2 - 4
	Max. flexible with ferrule - ferrule type (mm ²)	2.5 - WP25/14	2.5 - WP25/14
Electrical characteristics According to European standard IEC EN 60947-7-1	Max AC/DC Voltage (V)	630	630
	Max current with rated cross-section (A)	24	24
	Section Caliber	A3	A3
Electrical characteristics According to UL	Max AC/DC Voltage (V)	600	600
	Max current with rated cross-section (A)	20	20
	Section Min-Max (AWG)	28 - 12	28 - 12
	Tightening torque (lb.in)	8	8
Electrical characteristics According to ATEX directive and IEC ex standard	Max AC/DC Voltage (V)	400	-
	Max current with rated cross-section (A)	24	-
	Operating temperature (°C)	-40 ÷ +80	-
Rated impulse withstand voltage/pollution degree		8 KV / 3	8 KV / 3
Insulation stripping length (mm)		9	9
tightening torque value Nominal / Max (Nm)		0.4 / 0.8	0.4 / 0.8
Length (mm)		70	70
Width (mm)		5	5
Height mounted on TH35/7,5 (mm)		66	66
Height mounted on TH35/15 (mm)		74	74
Height mounted on G32 (mm)		-	-
Insulation material temperature index (EN 60216-1) (°C)		130	130
Plastic material		Polyamide UL94V-0	Polyamide UL94V-0

APPROVALS



ACCESSORIES			
End section	Grey	DBC/PT/GR (cod. DB101GR)	DBC/PT/GR (cod. DB101GR)
	Beige	DBC/PT (cod. DB101)	DBC/PT (cod. DB101)
	Blue	DBC/PT (ExI) (cod. DB201)	DBC/PT (ExI) (cod. DB201)
	Thickness (mm)	1.5	1.5
Cross connection	PTC or other versions (1)	PTC/2/... (cod. PTC02...)	PTC/2/... (cod. PTC02...)
	PTP version (1)	PTP/2D/... (cod. PTP02D...)	PTP/2D/... (cod. PTP02D...)
	Rated current / Rated current ATEX applications (A)	24 / 21	24 / 21
Cross connection identification strip	green	PTC/SP (cod. PTC0990)	PTC/SP (cod. PTC0990)
Switchable cross connection		-	-
Multiple common bar	250 mm	-	-
Shunting screw and sleeve	standard / Ex e version	-	-
	internal jumper	-	-
	internal jumper + external jumper	-	-
Coloured partition	red	DFU/7/R (cod. DU07R)	DFU/7/R (cod. DU07R)
Cross connection barred (upper level)	red	DFM/800 (cod. DF800) - DFM/900 (cod. DF900)	DFM/800 (cod. DF800) - DFM/900 (cod. DF900)
Cross connection barred (lower level)	red	DFM/500 (cod. DF500)	DFM/500 (cod. DF500)
Cross connection barrier	red	-	-
Test plug socket		-	-
Test plug		-	-
Modular test plug		-	-
Numbering strip		CNU/8/51 (cod. NU0851S)	CNU/8/51 (cod. NU0851S)
Single marking tag		CNU/8/51 (cod. NU0851S)	CNU/8/51 (cod. NU0851S)
		CNU/8/51 (cod. NU0851S)	CNU/8/51 (cod. NU0851S)
		-	-
Warning plate	on adjacent terminal blocks	-	-
Cover for cross-connection		-	-
End bracket	Snap-fit TH35 and G32	BTU (cod. BT005)	BTU (cod. BT005)
	Snap-fit TH35	BTO (cod. BT007)	BTO (cod. BT007)
	Screw TH35	-	-
	Screw G32	-	-



IMQ 17 ATEX 001 U
I M2 Ex eb I Mb
II 2 G Ex eb IIC Gb

IECEx IMQ 17.0001U
Ex eb I Mb
Ex eb IIC Gb

(1) See chapter accessories for more details

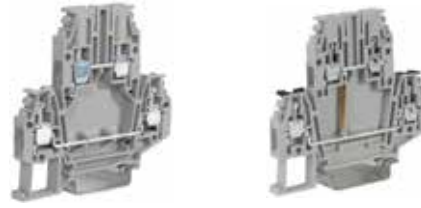

GREY VERSION	CODE	DB400GR	DB417GR
	TYPE	DBC.4/GR	DBC.4/CI/GR
BEIGE VERSION	CODE		
	TYPE		
BLUE VERSION	CODE	DB500	DB517
	TYPE	DBC.4 (EX)I	DBC.4/CI (EX)I

TECHNICAL CHARACTERISTICS

Function/type		2 levels	2 levels with internal connection
Rated cross-section	(mm ²)	4	4
Connecting capacity	Flexible	0.2 - 6	0.2 - 6
	Rigid	0.2 - 6	0.2 - 6
	Max. flexible with ferrule - ferrule type	4 - WP40/16	4 - WP40/16
Electrical characteristics According to European standard IEC EN 60947-7-1	Max AC/DC Voltage	[V] 630	630
	Max current with rated cross-section	[A] 32	32
	Section	Caliber A4	A4
Electrical characteristics According to UL	Max AC/DC Voltage	[V] 600	600
	Max current with rated cross-section	[A] 30	30
	Section Min-Max	[AWG] 20 - 10	20 - 10
	Tightening torque	[lb.in] 4.4	4.4
Electrical characteristics According to ATEX directive and IEC ex standard	Max AC/DC Voltage	[V] 400	-
	Max current with rated cross-section	[A] 28	-
	Operating temperature	[°C] -40 ÷ +80	-
Rated impulse withstand voltage/pollution degree		8 KV / 3	8 KV / 3
Insulation stripping length	(mm)	9	9
tightening torque value Nominal / Max	(Nm)	0,5 / 1	0,5 / 1
Length	(mm)	70	70
Width	(mm)	6	6
Height mounted on TH35/7,5	(mm)	66	66
Height mounted on TH35/15	(mm)	74	74
Height mounted on G32	(mm)	-	-
Insulation material temperature index (EN 60216-1)	(°C)	130	130
Plastic material		Polyamide UL94V-0	Polyamide UL94V-0

APPROVALS



ACCESSORIES			
End section	Grey	DBC.4/PT/GR (cod. DB401GR)	DBC.4/PT/GR (cod. DB401GR)
	Beige	-	-
	Blue	DBC.4/PT (Ex)I (cod. DB402)	DBC.4/PT (Ex)I (cod. DB402)
	Thickness	(mm) 1.5	1.5
Cross connection	PTC or other versions (1)	PTC/4/... (cod. PTC04...)	PTC/4/... (cod. PTC04...)
	PTP version (1)	PTP/4D/... (cod. PTP04D...)	PTP/4D/... (cod. PTP04D...)
	Rated current / Rated current ATEX applications	[A] 32 / 25	32 / 25
Cross connection identification strip	green	PTC/SP (cod. PTC0990)	PTC/SP (cod. PTC0990)
Switchable cross connection		-	-
Multiple common bar	250 mm	-	-
Shunting screw and sleeve	standard / Ex e version	-	-
	internal jumper	-	-
	internal jumper + external jumper	-	-
Coloured partition	red	DFU/7/R (cod. DU07R)	DFU/7/R (cod. DU07R)
Cross connection barred (upper level)	red	DFM/800 (cod. DF800) - DFM/900 (cod. DF900)	DFM/800 (cod. DF800) - DFM/900 (cod. DF900)
Cross connection barred (lower level)	red	DFM/500 (cod. DF500)	DFM/500 (cod. DF500)
Cross connection barrier	red	-	-
Test plug socket		-	-
Test plug		-	-
Modular test plug		-	-
Numbering strip		CNU/8/51 (cod. NU0851S)	CNU/8/51 (cod. NU0851S)
Single marking tag		CNU/8/51 (cod. NU0851S)	CNU/8/51 (cod. NU0851S)
		CNU/8/51 (cod. NU0851S)	CNU/8/51 (cod. NU0851S)
		-	-
Warning plate	on adjacent terminal blocks	-	-
Cover for cross-connection		-	-
End bracket	Snap-fit TH35 and G32	BTU (cod. BT005)	BTU (cod. BT005)
	Snap-fit TH35	BTO (cod. BT007)	BTO (cod. BT007)
	Screw TH35	BT/3 (cod. BT003)	BT/3 (cod. BT003)
	Screw G32	-	-



CESI 03 ATEX 162 U
I M2 Ex eb I Mb
II 2 G Ex eb IIC Gb

IECEx CES 11.0007U
Ex eb I Mb
Ex eb IIC Gb

(1) See chapter accessories for more details



GREY VERSION	CODE	DS100GR	DS117GR
	TYPE	DAS.4/GR	DAS.4/CI/GR
BEIGE VERSION	CODE	DS100	DS117
	TYPE	DAS.4	DAS.4/CI
BLUE VERSION	CODE	DS200	DS217
	TYPE	DAS.4 (EX)I	DAS.4/CI (EX)I

TECHNICAL CHARACTERISTICS

Function/type		2 levels	2 levels with internal jumper mounted
Rated cross-section	(mm ²)	4	4
Connecting capacity	Flexible (mm ²)	0.2 - 6	0.2 - 6
	Rigid (mm ²)	0.2 - 6	0.2 - 6
	Max. flexible with ferrule - ferrule type (mm ²)	4 - WP40/16	4 - WP40/16
Electrical characteristics According to European standard IEC EN 60947-7-1	Max AC/DC Voltage (V)	630	630
	Max current with rated cross-section (A)	30	30
	Section Caliber	A4	A4
Electrical characteristics According to UL	Max AC/DC Voltage (V)	600	600
	Max current with rated cross-section (A)	20	20
	Section Min-Max (AWG)	20 - 10	20 - 10
	Tightening torque (lb.in)	8.9	8.9
Electrical characteristics According to ATEX directive and IEC ex standard	Max AC/DC Voltage (V)	400	-
	Max current with rated cross-section (A)	28	-
	Operating temperature (°C)	-40 ÷ +110	-
Rated impulse withstand voltage/pollution degree		8 KV / 3	8 KV / 3
Insulation stripping length (mm)		9	9
tightening torque value Nominal / Max (Nm)		0.5 / 1.2	0.5 / 1.2
Length (mm)		64	64
Width (mm)		6	6
Height mounted on TH35/7,5 (mm)		62	62
Height mounted on TH35/15 (mm)		70	70
Height mounted on G32 (mm)		66	66
Insulation material temperature index (EN 60216-1) (°C)		130	130
Plastic material		Polyamide UL94V-0	Polyamide UL94V-0

APPROVALS



ACCESSORIES			
End section	Grey	DAS/PT/GR (cod. DS101GR)	DAS/PT/GR (cod. DS101GR)
	Beige	DAS/PT (cod. DS101)	DAS/PT (cod. DS101)
	Blue	DAS/PT (Ex)i (cod. DS201)	DAS/PT (Ex)i (cod. DS201)
	Thickness (mm)	1.5	1.5
Cross connection	PTC or other versions (1)	PM/.../... (cod. PM...)	PM/.../... (cod. PM...)
	PTP version (1)	-	-
	Rated current / Rated current ATEX applications (A)	30 / -	30 / -
Cross connection identification strip	green	-	-
Switchable cross connection		POS/43 (cod. POS43)	POS/43 (cod. POS43)
Multiple common bar	250 mm	PMP/58 (cod. PMP58)	PMP/58 (cod. PMP58)
Shunting screw and sleeve	standard / Ex e version	CPM/01 (cod. CPM01) - CPX/01 (cod. CPX01)	CPM/01 (cod. CPM01) - CPX/01 (cod. CPX01)
	internal jumper	DAS/VCI (cod. DS107)	-
	internal jumper + external jumper	DAS/VCE (cod. DS108)	DAS/VCE (cod. DS108)
Coloured partition	red	DFU/7/R (cod. DU07R)	DFU/7/R (cod. DU07R)
Cross connection barred (upper level)	red	-	-
Cross connection barred (lower level)	red	-	-
Cross connection barrier	red	-	-
Test plug socket		PSD/A (cod. PD001)	PSD/A (cod. PD001)
Test plug		SDD/1 (cod. DD001)	SDD/1 (cod. DD001)
Modular test plug		-	-
Numbering strip		CNU/8/61 (cod. NU0861S)	CNU/8/61 (cod. NU0861S)
Single marking tag		CNU/8/61 (cod. NU0861S)	CNU/8/61 (cod. NU0861S)
Warning plate	on adjacent terminal blocks	-	-
Cover for cross-connection		PRP/5 (cod. PRP05)	PRP/5 (cod. PRP05)
End bracket	Snap-fit TH35 and G32	BTU (cod. BT005)	BTU (cod. BT005)
	Snap-fit TH35	BTO (cod. BT007)	BTO (cod. BT007)
	Screw TH35	BT/3 (cod. BT003)	BT/3 (cod. BT003)
	Screw G32	BT/DIN/PO (cod. BT001)	BT/DIN/PO (cod. BT001)

AVAILABLE UNTIL STOCKS LAST



[1] See chapter accessories for more details

GREY VERSION	CODE	DS110GR	DS400GR
	TYPE	DAS.4/SS/GR	DSS.4/GR
BEIGE VERSION	CODE	DS110	DS400
	TYPE	DAS.4/SS	DSS.4
BLUE VERSION	CODE		
	TYPE		

TECHNICAL CHARACTERISTICS

Function/type		2 levels with solder lugs	2 levels disconnect
Rated cross-section	(mm ²)	4	4
Connecting capacity	Flexible	0.2 - 6	0.2 - 6
	Rigid	0.2 - 6	0.2 - 6
	Max. flexible with ferrule - ferrule type	4 - WP40/16	4 - WP40/16
Electrical characteristics According to European standard IEC EN 60947-7-1	Max AC/DC Voltage	[V] 320-500	400
	Max current with rated cross-section	[A] 20	24 upper level /32 lower level
	Section	Caliber A4	A4
Electrical characteristics According to UL	Max AC/DC Voltage	[V] -	300
	Max current with rated cross-section	[A] -	24 upper level /32 lower level
	Section Min-Max	[AWG] -	26 - 10
	Tightening torque	[lb.in] -	4.4
Electrical characteristics According to ATEX directive and IEC ex standard	Max AC/DC Voltage	[V] -	-
	Max current with rated cross-section	[A] -	-
	Operating temperature	[°C] -	-
Rated impulse withstand voltage/pollution degree		4 KV / 3	6 KV / 3
Insulation stripping length	(mm)	9	9
tightening torque value Nominal / Max	(Nm)	0.5 / 1.2	0.5 / 1.2
Length	(mm)	80	78
Width	(mm)	6	6
Height mounted on TH35/7,5	(mm)	62	62
Height mounted on TH35/15	(mm)	70	70
Height mounted on G32	(mm)	66	66
Insulation material temperature index (EN 60216-1)	(°C)	130	130
Plastic material		Polyamide UL94V-0	Polyamide UL94V-0

APPROVALS

ACCESSORIES			
End section	Grey	DAS/PT/GR (cod. DS101GR)	DSS/PT/GR (cod. DS301GR)
	Beige	DAS/PT (cod. DS101)	DSS/PT (cod. DS301)
	Blue	-	-
	Thickness (mm)	1.5	1.5
Cross connection	PTC or other versions (1)	PM/.../... (cod. PM...)	PTC/4/... (cod. PTC04...)
	PTP version (1)	-	PTP/4/... (cod. PTP04...)
	Rated current / Rated current ATEX applications [A]	32 / -	32 / -
Cross connection identification strip	green	-	PTC/SP (cod. PTC0990)
Switchable cross connection		POS/43 (cod. POS43)	-
Multiple common bar	250 mm	PMP/58 (cod. PMP58)	-
Shunting screw and sleeve	standard / Ex e version	CPM/01 (cod. CPM01) - CPX/01 (cod. CPX01)	-
	internal jumper	-	-
	internal jumper + external jumper	-	-
Coloured partition	red	DFU/7/R (cod. DU07R)	DFU/7/R (cod. DU07R)
Cross connection barred (upper level)	red	-	DFM/500 (cod. DF500)
Cross connection barred (lower level)	red	-	-
Cross connection barrier	red	-	-
Test plug socket		PSD/A (cod. PD001)	-
Test plug		SDD/1 (cod. DD001)	-
Modular test plug		-	-
Numbering strip		CNU/8/61 (cod. NU0861S)	CNU/8/61 (cod. NU0861S)
Single marking tag		CNU/8/61 (cod. NU0861S)	CNU/8/51 (cod. NU0851S)
		CNU/8/51 (cod. NU0851S)	CNU/8/51 (cod. NU0851S)
		-	-
Warning plate	on adjacent terminal blocks	-	-
Cover for cross-connection		PRP/5 (cod. PRP05)	-
End bracket	Snap-fit TH35 and G32	BTU (cod. BT005)	BTU (cod. BT005)
	Snap-fit TH35	BTO (cod. BT007)	BTO (cod. BT007)
	Screw TH35	BT/3 (cod. BT003)	BT/3 (cod. BT003)
	Screw G32	BT/DIN/PO (cod. BT001)	BT/DIN/PO (cod. BT001)

(1) See chapter accessories for more details



GREY VERSION	CODE	FV100GR	FF100GR
	TYPE	FVS.4/GR	FFS.4/GR
BEIGE VERSION	CODE	FV100	FF100
	TYPE	FVS.4	FFS.4
BLUE VERSION	CODE		
	TYPE		



TECHNICAL CHARACTERISTICS

Function/type		2 levels with special connections	2 levels with special connections
Rated cross-section		4	4
Connecting capacity	Flexible	0.2 - 6	0.2 - 6
	Rigid	0.2 - 6	0.2 - 6
	Max. flexible with ferrule - ferrule type	4 - WP40/16	4 - WP40/16
Electrical characteristics According to European standard IEC EN 60947-7-1	Max AC/DC Voltage	320	320
	Max current with rated cross-section	20	20
	Section	A4	A4
Electrical characteristics According to UL	Max AC/DC Voltage	600	600
	Max current with rated cross-section	20	20
	Section Min-Max	20 - 10	20 - 10
	Tightening torque	8.9	8.9
Electrical characteristics According to ATEX directive and IEC ex standard	Max AC/DC Voltage	-	-
	Max current with rated cross-section	-	-
	Operating temperature	-	-
Rated impulse withstand voltage/pollution degree		6 KV / 3	6 KV / 3
Insulation stripping length	(mm)	12	12
tightening torque value Nominal / Max	(Nm)	0.5 / 1.2	0.5 / 1.2
Length	(mm)	64	64
Width	(mm)	6.5	6.5
Height mounted on TH35/7,5	(mm)	69	69
Height mounted on TH35/15	(mm)	77	77
Height mounted on G32	(mm)	73	73
Insulation material temperature index (EN 60216-1)	(°C)	130	130
Plastic material		Polyamide UL94V-0	Polyamide UL94V-0

FVS/VCI - Cat. No. FV107
Shunting screws and sleeves for internal connection between the front and rear conducting bodies of terminal block type FVS.4



FVS/VCE - Code FV108
Screw and sleeve which, besides the internal connection, creates, using the PMP common bar, parallel between contiguous terminal blocks

APPROVALS

--	--	--

ACCESSORIES

End section	Grey	FVS/PT/GR (cod. FV101GR)	FFS/PT/GR (cod. FF101GR)
	Beige	FVS/PT (cod. FV101)	FFS/PT (cod. FF101)
	Blue	-	-
Cross connection	Thickness (mm)	1.5	1.5
	PTC or other versions (1)	PM/41/... (COD. PM41...)	PM/41/... (COD. PM41...)
	PTP version (1)	-	-
Cross connection identification strip	Rated current / Rated current ATEX applications (A)	32 / -	32 / -
	green	-	-
Switchable cross connection		POS/72 (cod. POS72)	POS/72 (cod. POS72)
Multiple common bar		PMP/42 (cod. PMP42)	PMP/42 (cod. PMP42)
	250 mm	CPM/01 (cod. CPM01) - CPX/01 (cod. CPX01)	CPM/01 (cod. CPM01) - CPX/01 (cod. CPX01)
Shunting screw and sleeve	standard / Ex e version	FVS/VCI (cod. FV107)	-
	internal jumper	FVS/VCE (cod. FV108)	-
	internal jumper + external jumper	DFU/6/R (cod. DU06R)	-
Coloured partition	red	-	-
Cross connection barred (upper level)	red	-	-
Cross connection barred (lower level)	red	-	-
Cross connection barrier	red	-	-
Test plug socket		PSD/A (cod. PD001)	PSD/A (cod. PD001)
Test plug		SDD/1 (cod. DD001)	SDD/1 (cod. DD001)
Modular test plug		-	-
Numbering strip		CNU/8/61 (cod. NU0861S)	CNU/8/61 (cod. NU0861S)
		CNU/8/51 (cod. NU0851S)	CNU/8/51 (cod. NU0851S)
		CNU/8/51 (cod. NU0851S)	CNU/8/51 (cod. NU0851S)
Single marking tag		-	-
Warning plate	on adjacent terminal blocks	-	-
Cover for cross-connection		PRP/6 (cod. PRP06)	PRP/6 (cod. PRP06)
	Snap-fit TH35 and G32	BTU (cod. BT005)	BTU (cod. BT005)
End bracket	Snap-fit TH35	BT0 (cod. BT007)	BT0 (cod. BT007)
	Screw TH35	BT/3 (cod. BT003)	BT/3 (cod. BT003)
	Screw G32	BT/DIN/PO (cod. BT001)	BT/DIN/PO (cod. BT001)

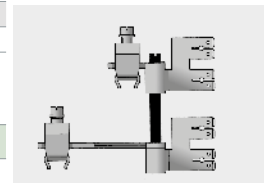

VCI
internal cross connection

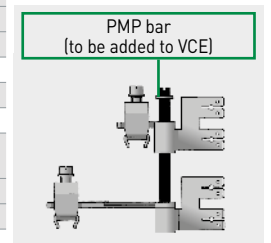

VCE
internal + front adjoining cross-connection

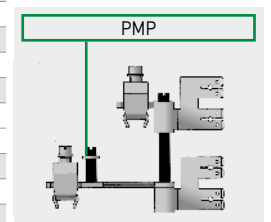

VCI + PM
internal parallel + rear adjoining cross connection

- with LOCK system

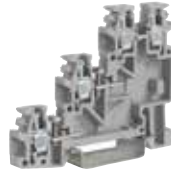

(1) See chapter accessories for more details

(2) A special version with green LED is available. TLS.2/T (cod. TL120) with green LED between upper and intermediate levels. TLS.2/U (cod. TL110) with green LED between upper and lower levels.

GREY VERSION	CODE	TL100GR
	TYPE	TLS.2/GR
BEIGE VERSION	CODE	TL100
	TYPE	TLS.2
BLUE VERSION	CODE	
	TYPE	

TECHNICAL CHARACTERISTICS

Function/type		three level - for sensors
Rated cross-section	(mm ²)	2.5
Connecting capacity	Flexible (mm ²)	0.2 - 4
	Rigid (mm ²)	0.2 - 4
	Max. flexible with ferrule - ferrule type (mm ²)	2.5 - WP25/14
Electrical characteristics According to European standard IEC EN 60947-7-1	Max AC/DC Voltage (V)	250
	Max current with rated cross-section (A)	24
	Section Caliber	A3
Electrical characteristics According to UL	Max AC/DC Voltage (V)	600
	Max current with rated cross-section (A)	15
	Section Min-Max (AWG)	20-12
	Tightening torque (lb.in)	3.5
Electrical characteristics According to ATEX directive and IEC ex standard	Max AC/DC Voltage (V)	-
	Max current with rated cross-section (A)	-
	Operating temperature (°C)	-
Rated impulse withstand voltage/pollution degree		4 KV / 3
Insulation stripping length	(mm)	8
tightening torque value Nominal / Max	(Nm)	0.4 / 0.8
Length	(mm)	62.5
Width	(mm)	6.2
Height mounted on TH35/7,5	(mm)	52
Height mounted on TH35/15	(mm)	60
Height mounted on G32	(mm)	-
Insulation material temperature index (EN 60216-1)	(°C)	130
Plastic material		Polyamide UL94V-0



APPROVALS

ACCESSORIES		
End section	Grey	TLS/PT/GR (cod. TL101GR)
	Beige	TLS/PT (cod. TL101)
	Blue	-
	Thickness (mm)	1.5
Cross connection	PTC or other versions (1)	PM/.../... (cod. PM...)
	PTP version (1)	-
	Rated current / Rated current ATEX applications (A)	24 / -
Cross connection identification strip	green	-
Switchable cross connection		POS/41 (cod. POS41)
Multiple common bar	250 mm	PMP/02 (cod. PMP02)
Shunting screw and sleeve	standard / Ex e version	-
	internal jumper	-
	internal jumper + external jumper	-
Coloured partition	red	DFU/3/R (cod. DU03R)
Cross connection barred (upper level)	red	-
Cross connection barred (lower level)	red	-
Cross connection barrier	red	DFM/400 (cod. DF400)
Test plug socket		PSD/A (cod. PD001)
Test plug		SDD/1 (cod. DD001)
Modular test plug		-
Numbering strip		CNU/8/51 (cod. NU0851)
Single marking tag		CNU/8/51 (cod. NU0851)
		CNU/8/51 (cod. NU0851)
		-
Warning plate	on adjacent terminal blocks	-
Cover for cross-connection		PRP/5 (cod. PRP05)
End bracket	Snap-fit TH35 and G32	BTU (cod. BT005)
	Snap-fit TH35	BT0 (cod. BT007)
	Screw TH35	BT/3 (cod. BT003)
	Screw G32	-

For the installation on limited longitudinal space where high density wiring is needed together with reliable insulation, special feed-through two/three level terminal blocks are available. The three level terminal blocks are suitable for circuits which are to be used and connected with specific equipment, as for example proximity sensors. In fact, through the combined use of TLS.2 and TLD.2 terminal blocks it is possible to connect in an optimal and economic manner both power supply conductors on input to the sensor, and those on output carrying the signal of the same. Particularly in the **TLS.2 terminal block**, the intermediate and lower levels can be used to feed the sensors in d.c.; the feeding is distributed on the adjoining elements of the terminal board by means of a special **LOCK** connection system.

The above mentioned conducting bodies have a fork, pointed towards the exterior of the terminal block, which connects to the homologous element of the adjoining terminal block. The resulting contact is clamped with a screw, supplied already inserted in the conductor element.

The LOCK system, above described, allows the connection of positive and negative poles, without the use of any other parallel cross connection. At the upper, feed-through level, the conductor for the return signal of the sensor is connected; inserting PRP/5 coloured protections in the special channels guarantees against all possible contact of the live parts and enables immediate identification of the polarity (Red for +, Blue for -).

TLD.2 terminal block is perfectly compatible with the **TLS.2** for the connection of proximity sensors, as it has the same electrical and mechanical characteristics. Two of six tightening units can be connected to the sensor feeding cables and distribute the power supply to the other sensors.

The cross-connection between the intermediate and lower levels of these terminal blocks to the contiguous ones of the TLS.2 can be performed by means of the two screws provided in the fork type conducting bodies of the TLS.2 - the first of the Series - free from whatever connection; between the TLD.2 and TLS.2 terminal blocks a TLD/PI intermediate end section must be interposed, to ensure electric insulation of the TLD.2 terminal block conducting parts, which otherwise would be uncovered.

TLD.2 terminal block can also be used for other connecting applications, in other types of circuits.



(1) See chapter accessories for more details

GREY VERSION	CODE	TL200GR	TL400GR	TL500GR
	TYPE	TLD.2/GR	TLE.2/GR	TDE.2/GR
BEIGE VERSION	CODE	TL200	TL400	TL500
	TYPE	TLD.2	TLE.2	TDE.2
BLUE VERSION	CODE	TL300		
	TYPE	TLD.2 (EXI)		

TECHNICAL CHARACTERISTICS

Function/type		3 levels	2 levels + earth	2 levels feed through + earth
Rated cross-section	(mm ²)	2.5	2.5	2.5
Connecting capacity	Flexible (mm ²)	0.2 - 4	0.2 - 4	0.2 - 4
	Rigid (mm ²)	0.2 - 4	0.2 - 4	0.2 - 4
	Max. flexible with ferrule - ferrule type (mm ²)	2.5 - WP25/14	2.5 - WP25/14	2.5 - WP25/14
Electrical characteristics According to European standard IEC EN 60947-7-1	Max AC/DC Voltage (V)	250	250	250
	Max current with rated cross-section (A)	24	24	24
	Section Caliber	A3	A3	A3
Electrical characteristics According to UL	Max AC/DC Voltage (V)	600	600	600
	Max current with rated cross-section (A)	15	20	20
	Section Min-Max (AWG)	20-12	20-12	20-12
	Tightening torque (lb.in)	3.5	3.5	3.5
Electrical characteristics According to ATEX directive and IEC ex standard	Max AC/DC Voltage (V)	-	-	-
	Max current with rated cross-section (A)	-	-	-
	Operating temperature (°C)	-	-	-
Rated impulse withstand voltage/pollution degree		4 KV / 3	4 KV / 3	4 KV / 3
Insulation stripping length	(mm)	8	8	8
tightening torque value Nominal / Max	(Nm)	0.4 / 0.8	0.4 / 0.8	0.4 / 0.8
Length	(mm)	85	62.5	85
Width	(mm)	6.2	6.2	6.2
Height mounted on TH35/7,5	(mm)	52	52	52
Height mounted on TH35/15	(mm)	60	60	60
Height mounted on G32	(mm)	-	-	-
Insulation material temperature index (EN 60216-1)	(°C)	130	130	130
Plastic material		Polyamide UL94V-0	Polyamide UL94V-0	Polyamide UL94V-0

APPROVALS

ACCESSORIES				
End section	Grey	TLD/PT/GR (cod. TL201GR)	TLS/PT/GR (cod. TL101GR)	TLS/PT/GR (cod. TL101GR)
	Beige	TLD/PT (cod. TL201)	TLS/PT (cod. TL101)	TLS/PT (cod. TL101)
	Blue	-	-	-
	Thickness (mm)	1.5	1.5	1.5
Cross connection	PTC or other versions (1)	PM/.../... (cod. PM...)	PM/.../... (cod. PM...)	PM/.../... (cod. PM...)
	PTP version (1)	-	-	-
	Rated current / Rated current ATEX applications (A)	24 / -	24 / -	24 / -
Cross connection identification strip	green	-	-	-
Switchable cross connection		POS/41 (cod. POS41)	POS/41 (cod. POS41)	POS/41 (cod. POS41)
Multiple common bar	250 mm	PMP/02 (cod. PMP02)	PMP/02 (cod. PMP02)	PMP/02 (cod. PMP02)
Shunting screw and sleeve	standard / Ex e version	-	-	-
	internal jumper	-	-	-
	internal jumper + external jumper	-	-	-
Coloured partition	red	DFU/3/R (cod. DU03R)	DFU/3/R (cod. DU03R)	DFU/3/R (cod. DU03R)
Cross connection barred (upper level)	red	-	-	-
Cross connection barred (lower level)	red	-	-	-
Cross connection barrier	red	DFM/400 (cod. DF400)	DFM/400 (cod. DF400)	DFM/400 (cod. DF400)
Test plug socket		PSD/A (cod. PD001)	PSD/A (cod. PD001)	PSD/A (cod. PD001)
Test plug		SDD/1 (cod. DD001)	SDD/1 (cod. DD001)	SDD/1 (cod. DD001)
Modular test plug		-	-	-
Numbering strip		CNU/8/51 (cod. NU0851)	CNU/8/51 (cod. NU0851)	CNU/8/51 (cod. NU0851)
Single marking tag		CNU/8/51 (cod. NU0851)	CNU/8/51 (cod. NU0851)	CNU/8/51 (cod. NU0851)
		CNU/8/51 (cod. NU0851)	CNU/8/51 (cod. NU0851)	CNU/8/51 (cod. NU0851)
	Warning plate on adjacent terminal blocks	-	-	-
Cover for cross-connection		PRP/5 (cod. PRP05)	PRP/5 (cod. PRP05)	PRP/5 (cod. PRP05)
End bracket	Snap-fit TH35 and G32	BTU (cod. BT005)	BTU (cod. BT005)	BTU (cod. BT005)
	Snap-fit TH35	BTO (cod. BT007)	BTO (cod. BT007)	BTO (cod. BT007)
	Screw TH35	BT/3 (cod. BT003)	BT/3 (cod. BT003)	BT/3 (cod. BT003)
	Screw G32	-	-	-

- for Ø 5 x 20 mm fuses, with possibility of warning of any broken fuse through lamp
- for Ø 6.3 x 32 mm fuses



(1) See chapter accessories for more details

GREY VERSION		CODE	SR500GR	SR300GR	Type	SFR.6/M	SFR.6	
BEIGE VERSION		TYPE	SFR.6/M/GR	SFR.6/GR	Voltage (V)	250	250	
BLUE VERSION		CODE	SR500	SR300	Current (A)	6.3/10 max.	2.5/10 max.	
		TYPE	SFR.6/M	SFR.6	PROTECTION AGAINST OVERLOAD AND SHORT CIRCUIT			
		TYPE	SR600	SR400	Single configuration (pv)	2.5W (6.3A)	4W (10A)	
			SFR.6/M [EXI]	SFR.6 [EXI]	Composite configuration (pv)	2.5W (6.3A)	2.5W (2.5A)	
TECHNICAL CHARACTERISTICS								
Function/type			Fuse-holders ø 5x20	Fuse-holders ø 6x32	PROTECTION AGAINST SHORT CIRCUIT			
Rated cross-section		(mm ²)	6	6	Single configuration (pvk)	4W (10A)	4W (10A)	
Connecting capacity		Flexible	0.2 - 10	0.2 - 10	Composite configuration (pv)	2.5W (6.3A)	2.5W (2.5A)	
		Rigid	0.2 - 10	0.2 - 10				
		Max. flexible with ferrule - ferrule type	(mm ²)	6 - WP60/20	6 - WP60/20			
Electrical characteristics According to European standard IEC EN 60947-7-1		Max AC/DC Voltage	(V)	630	PROTECTION AGAINST SHORT CIRCUIT			
		Max current with rated cross-section	(A)	10 A max. (19 A with CO/5)	10 A (33 A with cylinder)	Single configuration (pvk)	4W (10A)	4W (10A)
		Section	Caliber	A5	A5			
Electrical characteristics According to UL		Max AC/DC Voltage	(V)	600	600	Composite configuration (pvk)	4W (8A)	4W (10A)
		Max current with rated cross-section	(A)	6.3	10			
		Section Min-Max	(AWG)	20-8	20-8			
		Tightening torque	(lb.in)	13	13			
Rated impulse withstand voltage/pollution degree			6 KV / 3	6 KV / 3				
Insulation stripping length		(mm)	11	11				
tightening torque value Nominal / Max		(Nm)	0.8 / 1.4	0.8 / 1.4				
Length		(mm)	79	79				
Width		(mm)	10	10				
Height mounted on TH35/7,5		(mm)	59	59				
Height mounted on TH35/15		(mm)	67	67				
Height mounted on G32		(mm)	63	63				
Insulation material temperature index (EN 60216-1)		(°C)	130	130				
Plastic material			Polyamide UL94V-0	Polyamide UL94V-0				
APPROVALS								
ACCESSORIES								
End section		Grey	SFR.6/PT/GR (cod. SR301GR)	SFR.6/PT/GR (cod. SR301GR)				
		Beige	SFR.6/PT (cod. SR301)	SFR.6/PT (cod. SR301)				
		Blue	SFR.6/PT [Ex]i (cod. SR401)	SFR.6/PT [Ex]i (cod. SR401)				
		Thickness (mm)	1.5	1.5				
Cross connection		PTC or other versions (1)	PTC/20/... (cod. PTC20...)	PTC/20/... (cod. PTC20...)				
		PTP version (1)	-	-				
		Rated current / Rated current ATEX applications (A)	25	25				
Cross connection identification strip		green	PTC/SP (cod. PTC0990)	PTC/SP (cod. PTC0990)				
Coloured partition		red	DFU/7/R (cod. DU07R)	DFU/7/R (cod. DU07R)				
Cross connection barrier			DFM/300 (cod. DF300)	DFM/300 (cod. DF300)				
Miniature fuse		Ø 5 x 20 mm	F5 (cod. FN...)	-				
LED circuit nonpolarized		for voltage 12V 24V 48V AC/DC	-	-				
		for voltage 115V 230V AC/DC	-	-				
Lamp		for voltage 12V 24V AC/DC	KITLSN/12-24 (cod. KIT1224)	KITLSN/12-24 (cod. KIT1224)				
		for voltage 70V 380V AC/DC	KITLSN/70-380 (cod. KIT70380)	KITLSN/70-380 (cod. KIT70380)				
Terminal block with LED 12 ÷ 48 V non polarized micro-circuit			-	-				
Terminal block with LED 115 ÷ 230 V non polarized micro-circuit			-	-				
1 A diode cartridge / insert			-	-				
3 A diode cartridge / insert			-	-				
Terminal block with 1 A diode			-	-				
Terminal block with 3 A diode			-	-				
Single marking tag			CNU/08/51 (cod. CNU0851S)	CNU/08/51 (cod. CNU0851S)				
			CNU/10/61 (cod. CNU1061S)	CNU/10/61 (cod. CNU1061S)				
End bracket		Snap-fit TH35 and G32	BTU (cod. BT005)	BTU (cod. BT005)				
		Snap-fit TH35	BTO (cod. BT007)	BTO (cod. BT007)				
		Screw TH35	BT/3 (cod. BT003)	BT/3 (cod. BT003)				
		Screw G32	BT/DIN/PO (cod. BT001)	BT/DIN/PO (cod. BT001)				

SCREW CLAMP

- for Ø 5 x 20 mm fuses, with possibility of warning of any broken fuse through LED microcircuit (CIL/...)
- for Ø 6.3 x 32 mm fuses

AVAILABLE UNTIL STOCKS LAST

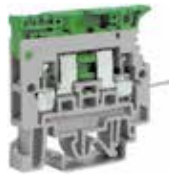

(1) See chapter accessories for more details

GREY VERSION	CODE	SF910GR	Type	SFR.4/VS
	TYPE	SFR.4/VS/GR	Voltage (V)	250
BEIGE VERSION	CODE	SF910	Current (A)	6.3
	TYPE	SFR.4/VS	PROTECTION AGAINST OVERLOAD AND SHORT CIRCUIT	
BLUE VERSION	CODE	-	Single configuration (pv)	2.5W (6.3A)
	TYPE	-	Composite configuration (pv)	1.6W (6.3A)

TECHNICAL CHARACTERISTICS

Function/type			Fuse-holders ø 5x20 with solder lug
Rated cross-section		(mm ²)	4
Connecting capacity	Flexible	(mm ²)	0.2 – 6
	Rigid	(mm ²)	0.2 – 6
	Max. flexible with ferrule - ferrule type	(mm ²)	4 - WP40/16
Electrical characteristics According to European standard IEC EN 60947-7-1	Max AC/DC Voltage	(V)	400
	Max current with rated cross-section	(A)	6.3 A max (15 A with C0/5)
	Section	Caliber	A4
Electrical characteristics According to UL	Max AC/DC Voltage	(V)	-
	Max current with rated cross-section	(A)	-
	Section Min-Max	(AWG)	-
	Tightening torque	(lb.in)	-
Rated impulse withstand voltage/pollution degree			4 KV / 3
Insulation stripping length		(mm)	11
tightening torque value Nominal / Max		(Nm)	0.5 / 1.2
Length		(mm)	65
Width		(mm)	8
Height mounted on TH35/7,5		(mm)	52
Height mounted on TH35/15		(mm)	60
Height mounted on G32		(mm)	56
Insulation material temperature index (EN 60216-1)		(°C)	130
Plastic material			Polyamide UL94V-0

PROTECTION AGAINST SHORT CIRCUIT	
Single configuration (pvk)	2.5W (6.3A)
Composite configuration (pvk)	2.5W (6.3A)

APPROVALS

ACCESSORIES

End section	Grey	SFR.4/PT/GR (cod. SF701GR)
	Beige	SFR.4/PT (cod. SF701)
	Blue	-
	Thickness	(mm) 1.5
Cross connection	PTC or other versions (1)	-
	PTP version (1)	-
	Rated current / Rated current ATEX applications (A)	-
Cross connection identification strip	green	-
Coloured partition	red	DFU/3/R (cod. DU03R)
Cross connection barrier		-
Miniature fuse	Ø 5 x 20 mm	F5 (cod. FN...)
LED circuit nonpolarized	for voltage 12V 24V 48V AC/DC	CIL/12-24-48 (cod. SF518)
	for voltage 115V 230V AC/DC	CIL/115-230 (cod. SF510)
Lamp	for voltage 12V 24V AC/DC	-
	for voltage 70V 380V AC/DC	-
Terminal block with LED 12 ÷ 48 V nonpolarized micro-circuit		-
Terminal block with LED 115 ÷ 230 V nonpolarized micro-circuit		-
1 A diode cartridge / insert		-
3 A diode cartridge / insert		-
Terminal block with 1 A diode		-
Terminal block with 3 A diode		-
Single marking tag		CNU/08/51 (cod. CNU0851S)
		CNU/10/61 (cod. CNU1061S)
End bracket	Snap-fit TH35 and G32	BTU (cod. BT005)
	Snap-fit TH35	BTO (cod. BT007)
	Screw TH35	BT/3 (cod. BT003)
	Screw G32	BT/DIN/P0 (cod. BT001)



- for Ø 5 x 20 mm fuses, with possibility of warning of any broken fuse through LED microcircuit (CIL/...)
- for 1 A diodes (types 1N4001 – 1N4007)



[1] See chapter accessories for more details
Components are not included

GREY VERSION	CODE	DA200GR
	TYPE	DSF.4/GR
BEIGE VERSION	CODE	DA200
	TYPE	DSF.4
BLUE VERSION	CODE	
	TYPE	

TECHNICAL CHARACTERISTICS

Function/type		Two levels fuse-holders ø 5x20 + feed through
Rated cross-section	(mm ²)	4
Connecting capacity	Flexible (mm ²)	0,2 ÷ 6
	Rigid (mm ²)	0,2 ÷ 6
	Max. flexible with ferrule - ferrule type (mm ²)	4 - WP40/16
Electrical characteristics According to European standard IEC EN 60947-7-1	Max AC/DC Voltage (V)	800
	Max current with rated cross-section (A)	6.3 A (10 A with CO/5) (upper level) 32 A (lower level)
Electrical characteristics According to UL	Section Caliber	A4
	Max AC/DC Voltage (V)	-
	Max current with rated cross-section (A)	-
	Section Min-Max (AWG)	-
	Tightening torque (lb.in)	-
Rated impulse withstand voltage/pollution degree		8 kV / 3
Insulation stripping length	(mm)	9
tightening torque value Nominal / Max	(Nm)	0,5 / 1,2
Length	(mm)	79.5
Width	(mm)	8
Height mounted on TH35/7,5	(mm)	69
Height mounted on TH35/15	(mm)	77
Height mounted on G32	(mm)	-
Insulation material temperature index (EN 60216-1)	(°C)	130
Plastic material		Polyamide UL94V-0



APPROVALS



ACCESSORIES

End section	Grey	DSF.4/PT/GR (cod. DS401GR)
	Beige	DSF.4/PT D(cod. DS401)
	Blue	-
	Thickness (mm)	1.5
Cross connection	PTC or other versions (1)	-
	PTP version (1)	-
	Rated current / Rated current ATEX applications (A)	-
Cross connection identification strip	green	-
Coloured partition	red	DFU/7/R (cod. DU07R)
Cross connection barrier		-
Miniature fuse	Ø 5 x 20 mm	F5 (cod. FN...)
LED circuit nonpolarized	for voltage 12V 24V 48V AC/DC	CIL/12-24-48 (cod. SF518)
	for voltage 115V 230V AC/DC	CIL/115-230 (cod. SF510)
Lamp	for voltage 12V 24V AC/DC	-
	for voltage 70V 380V AC/DC	-
Terminal block with LED 12 ÷ 48 V nonpolarized micro-circuit		DSF.4/GR/C12-48 (cod. DA518GR)
Terminal block with LED 115 ÷ 230 V nonpolarized micro-circuit		DSF.4/GR/C115-230 (cod. DA510GR)
1 A diode cartridge / insert		SFR/1A (cod. SF992)
3 A diode cartridge / insert		SFR/3A (cod. SF993)
Terminal block with 1 A diode		DSF.4/GR/D1A (cod. DA901GR)
Terminal block with 3 A diode		DSF.4/GR/D3A (cod. DA903GR)
Single marking tag		CNU/08/51 (cod. CNU0851S)
		CNU/10/61 (cod. CNU1061S)
End bracket	Snap-fit TH35 and G32	BTU (cod. BT005)
	Snap-fit TH35	BTO (cod. BT007)
	Screw TH35	BT/3 (cod. BT003)
	Screw G32	-

SCREW CLAMP

- for "blade" fuse in compliance with DIN 72581/3F – ISO 8820
- combinable with CPF05 components holder (see accessories chapter for more details)

[1] See chapter accessories for more details

[2] 10A max. with conducting element VL103 combined with CPF05. 6.3A max with fuse combined with CPF05

[3] Approvals referred to use with CPF/5 component holder cartridge



GREY VERSION	CODE TYPE	MF100GR	MPFA.4/GR	DA100GR	DSFA.4/GR
BEIGE VERSION	CODE TYPE	MF100	MPFA.4	DA100	DSFA.4

TECHNICAL CHARACTERISTICS

Function/type		Blade fuse holder	2 levels, blade fuse holder + feed through
Rated cross-section	(mm ²)	4	4
Connecting capacity	Flexible	0,2 ÷ 6	0,2 ÷ 6
	Rigid	0,2 ÷ 6	0,2 ÷ 6
	Max. flexible with ferrule - ferrule type	4 - WP40/16	4 - WP40/16
Electrical characteristics According to European standard IEC EN 60947-7-1	Max AC/DC Voltage	400	400
	Max current with rated cross-section	10 [2]	10 [2] / 32
Electrical characteristics According to UL	Section	Caliber A4	A4
	Max AC/DC Voltage	600	300
	Max current with rated cross-section	6.3	6.3-30
	Section Min - Max	[AWG] 26-10	26-10
	Tightening torque	4.4	4.4
Rated impulse withstand voltage/pollution degree		6 KV / 3	6 KV / 3
Insulation stripping length	(mm)	9	9
Tightening torque Nominal / Max.	(Nm)	0,5 / 1,2	0,5 / 1,2
Length	(mm)	47	78
Width	(mm)	6	6
Height mounted on TH35/7,5	(mm)	47	68
Height mounted on TH35/15	(mm)	55	75
Height mounted on G32	(mm)	51	72
Insulation material temperature index [EN 60216-1]	(°C)	130	130
Plastic material		polyamide UL94V-0	polyamide UL94V-0

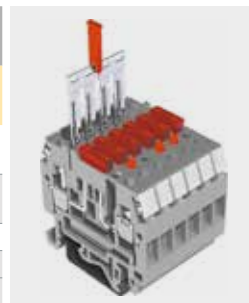

MPFA.4 – detail of the terminal blocks with numbering CNU/8 and CNU/8/51, "blade" fuse seen from the PTC/4 cross connection and seen from the PTC cross connection. The terminal block can be supplied already including a non-polarised LED warning circuit, to warn if the fuse breaks. Two versions are available, depending on the different power supply voltages.

APPROVALS

ACCESSORIES

End section	Grey	MPS.4/PT/GR (cod. MP901GR)	DSS/PT/GR (cod. DS301GR)
	Beige	MPS.4/PT (cod. MP901)	DSS/PT (cod. DS301)
	Blue	-	-
	Thickness (mm)	1.5	1.5
Cross connection	PTC version (1)	PTC/4/... (cod. PTC04...)	PTC/4/... (cod. PTC04...)
	Rated current (A)	32	32
Coloured partition	red	DFU/3/R (cod. DU03R)	DFU/7/R (cod. DU07R)
Cross connection barrier	red	DFM/500 (cod. DF500)	DFM/500 (cod. DF500)
Blade-type fuses according to DIN 72581/3F ISO 8820 - max voltage 32 V In = 2A, 5A, 7.5A, 15A (1)		F32/... (cod. FN032...)	F32/... (cod. FN032...)
Terminal block with LED 12V circuit nonpolarized		MPFA.4/L12 (cod. MF112)	DSFA.4/L12 (cod. DA112)
Terminal block with LED 24V circuit nonpolarized		MPFA.4/L24 (cod. MF124)	DSFA.4/L24 (cod. DA124)
Marking tag		CNU/08/51 (cod. CNU0851S)	CNU/08/51 (cod. CNU0851S)
		CNU/10/61 (cod. CNU1061S)	CNU/10/61 (cod. CNU1061S)
		BTU (cod. BT005)	BTU (cod. BT005)
End bracket	Snap-fit TH35 and G32	BTO (cod. BT007)	BTO (cod. BT007)
	Snap-fit TH35	BT/3 (cod. BT003)	BT/3 (cod. BT003)
	Screw TH35	BT/DIN/PO (cod. BT001)	BT/DIN/PO (cod. BT001)
	Screw G32		



DSFA.4 – detail of the terminal blocks with numbering CNU/8 and CNU/8/51, blade fuse and view of the PTC/4 cross connections on the upper level (upstream from the fuse) and on the lower level. The terminal block can be supplied already including a non-polarised LED warning circuit, to warn if the fuse breaks. Two versions are available, depending on the different power supply voltages. **DSFA.4/L12** code DA112 (complete with non-polarised 12 V LED circuit) **DSFA.4/L24** code DA124 (complete with non-polarised 24 V LED circuit)

SCREW CLAMP

- for Ø 6.3 x 32 mm fuses
- for Ø 6.3 x 32 mm fuses, with possibility of warning of any broken fuse through LED microcircuit (CIL/...)
- No end section required



(1) value referred to the insulation characteristics of the terminal blocks

BEIGE VERSION		CODE	FP100	FP300	FP200
		TYPE	FPC.10	FPL.10/C	FPL.10/L
TECHNICAL CHARACTERISTICS					
Function/type			fuse holder Ø 6.3 x 32 mm	fuse holder Ø 6.3 x 32 mm with LED	fuse holder Ø 6.3 x 32 mm with lamp
Rated cross-section		[mm ²]	10	10	10
Connecting capacity	Flexible	[mm ²]	1.5 - 16	1.5 - 16	1.5 - 16
	Rigid	[mm ²]	1.5 - 16	1.5 - 16	1.5 - 16
	Max. flexible with ferrule - ferrule type	[mm ²]	10 - WP100/21	10 - WP100/21	10 - WP100/21
Electrical characteristics According to European standard IEC EN 60947-7-1	Max AC/DC Voltage	[V]	800	800	800
	Max current with rated cross-section	[A]	10 A (20 A with SFC/CO)	10	10 A (20 A with SFC/CO)
Electrical characteristics According to UL	Section	Caliber	B6	B6	B6
	Max AC/DC Voltage	[V]	600	300	300
	Max current with rated cross-section	[A]	15	15	15
	Section Min - Max	[AWG]	20 - 6	20 - 6	20 - 6
	Tightening torque	[lb.in]	7	7	7
Rated impulse withstand voltage/pollution degree			6 KV (1) / 3	6 KV (1) / 3	6 KV (1) / 3
Insulation stripping length		[mm]	17	17	17
Tightening torque value Nominal / Max		[Nm]	1.2 / 1.9	1.2 / 1.9	1.2 / 1.9
Length		[mm]	63	63	63
Width		[mm]	12	12	12
Height mounted on TH35/7,5		[mm]	70	71	71
Height mounted on TH35/15		[mm]	78	79	79
Height mounted on G32		[mm]	74	75	75
Insulation material temperature index (EN 60216-1)		[°C]	130	130	130
Plastic material			polyamide UL94V-0	polyamide UL94V-0	polyamide UL94V-0
APPROVALS					
ACCESSORIES					
Coloured partition		red	DFU/6/R (cod. DU06R)	DFU/6/R (cod. DU06R)	DFU/6/R (cod. DU06R)
Test plug			SDD/2 (cod. DD002)	-	-
MSM handle		simultaneous disconnection of 6 terminal blocks	MSM (cod. FC103)	MSM (cod. FC103)	MSM (cod. FC103)
Neon lamp Ø 6 x 26 mm			-	-	LSN (cod. FL202)
Non polarized LED circuit		12-24-48V AC/DC voltages	-	CIL/12-24-48 (cod. SF518)	-
Non polarized LED circuit		115-230V AC/DC voltages	-	CIL/115-230 (cod. SF510)	-
Marking tag			CNU/08/51 (cod. NU0851S) CNU/10/61 (cod. NU1061S)	CNU/08/51 (cod. NU0851S) CNU/10/61 (cod. NU1061S)	CNU/08/51 (cod. NU0851S) CNU/10/61 (cod. NU1061S)
End bracket	Snap-fit TH35 and G32		BTU (cod. BT005)	BTU (cod. BT005)	BTU (cod. BT005)
	Snap-fit TH35		BTO (cod. BT007)	BTO (cod. BT007)	BTO (cod. BT007)
	Screw TH35		BT/3 (cod. BT003)	BT/3 (cod. BT003)	BT/3 (cod. BT003)
	Screw G32		BT/DIN/PO (cod. BT001)	BT/DIN/PO (cod. BT001)	BT/DIN/PO (cod. BT001)

SCREW CLAMP

- for Ø 5x20 mm fuses, with LED warning circuit capable of detecting intervention of the fuse
- with LED (CIL) microcircuits - non-polarised for operation under alternating and/or direct current



(1) See chapter accessories for more details

BEIGE VERSION WITH 12-24-48V LED CIRCUIT	CODE TYPE	SF948 SFR.4/C48		FP948 FPL.10/C48
BEIGE VERSION WITH 100-230V LED CIRCUIT	CODE TYPE	SF923 SFR.4/C230		FP923 FPL.10/C230
GREY VERSION WITH 12-24-48V LED CIRCUIT	CODE TYPE	SF948GR SFR.4/C48/GR	CBF448GR CBF.4/C48/GR	
GREY VERSION WITH 100-230V LED CIRCUIT	CODE TYPE	SF923GR SFR.4/C230/GR	CBF423GR CBF.4/C23/GR	

TECHNICAL CHARACTERISTICS

Function/type		For Ø 5 x 20 mm fuse and LED circuit	For Ø 5 x 20 mm fuse and LED circuit	For Ø 6.3 x 32 mm fuse and LED circuit
Rated cross-section	(mm²)	4	4	10
Connecting capacity	Flexible (mm²)	0.2 - 6	0.2 - 6	1.5 - 16
	Rigid (mm²)	0.2 - 6	0.2 - 6	1.5 - 16
	Max. flexible with ferrule - ferrule type (mm²)	4 - WP40/16	4 - WP40/16	10 - WP100/21
Electrical characteristics According to European standard IEC EN 60947-7-1	Max AC/DC Voltage (V)	800	630	800
	Max current with rated cross-section (A)	6.3	6.3 A max [20A con CO/5]	10
	Section Caliber	A4	A4	B6
Electrical characteristics According to UL	Max AC/DC Voltage (V)	600	600	300
	Max current with rated cross-section (A)	6.3	6.3	15
	Section Min - Max (AWG)	20-12	20 - 12	20 - 6
	Tightening torque (lb.in)	4.4	4.4	7
Rated impulse withstand voltage/pollution degree		6 KV / 3	6 KV / 3	6 KV / 3
Insulation stripping length	(mm)	11	11	17
Tightening torque value Nominal / Max	(Nm)	0.5 / 1.2	0.5 / 1	1.2 / 1.9
Length	(mm)	52	57	63
Width	(mm)	8	6	12
Height mounted on TH35/7,5	(mm)	52	76	71
Height mounted on TH35/15	(mm)	60	83	79
Height mounted on G32	(mm)	56	-	75
Insulation material temperature index (EN 60216-1)	(°C)	130	130	130
Plastic material		polyamide UL94V-0	polyamide UL94V-0	polyamide UL94V-0

APPROVALS



ACCESSORIES

End section	Grey	SFR/PT/GR (cod. SF701GR)	CBSF.2-4/PT/GR (cod. CB401GR)	-
	Beige	SFR/PT (cod. SF701)	-	-
	Thickness (mm)	1.5	1.5	-
Cross connection	PTC version (1)	-	PTC/4/... (cod. PTC04...)	-
	PTP version (1)	-	PTP/4/... (cod. PTP04...)	-
	Rated current (A)	-	32	-
Cross connection identification strip	green	-	PTC/SP (cod. PTC0990)	-
Coloured partition	red	DFU/3/R (cod. DU03R)	-	DFU/6/R (cod. DU06R)
MSM handle	simultaneous disconnection of 6 terminal blocks	-	-	MSM (cod. FC103)
Miniature fuse Ø 5 x 20 mm		F5/... (cod. FN...)	F5/... (cod. FN...)	-
Conducting element		CO/5 (cod. VL103)	CO/5 (cod. VL103)	-
		CNU/8/51 (cod. NU0851S)	CNU/8/51 (cod. NU0851S)	-
		CNU/10/61 (cod. NU1061S)	CNU/10/61 (cod. NU1061S)	-
Marking tag		BTU (cod. BT005)	BTU (cod. BT005)	BTU (cod. BT005)
	Snap-fit TH35 and G32	BTO (cod. BT007)	BTO (cod. BT007)	BTO (cod. BT007)
	Snap-fit TH35	BT/3 (cod. BT003)	BT/3 (cod. BT003)	BT/3 (cod. BT003)
	Screw TH35	BT/DIN/PO (cod. BT001)	-	BT/DIN/PO (cod. BT001)
	Screw G32			



(1) See chapter accessories for more details

GREY VERSION	CODE TYPE	CBS02GR CBS.2/GR	CBS04GR CBS.4/GR
BEIGE VERSION	CODE TYPE	CBS02 CBS.2	CBS04 CBS.4
BLUE VERSION	CODE TYPE	CBS02I CBS.2 (EX) I	CBS04I CBS.4 (EX) I

TECHNICAL CHARACTERISTICS

Function/type	"blade" switchable		"blade" switchable	
Rated cross-section	(mm ²)	2	4	
Connecting capacity	Flexible (mm ²)	0,2 ÷ 4	0,2 ÷ 6	
	Rigid (mm ²)	0,2 ÷ 4	0,2 ÷ 6	
	Max. flexible with ferrule - ferrule type (mm ²)	2 - WP25/14	4 - WP40/16	
Electrical characteristics According to European standard IEC EN 60947-7-1	Max AC/DC Voltage (V)	630	630	
	Max current with rated cross-section (A)	20	25	
	Section Caliber	A3	A4	
Electrical characteristics According to UL	Max AC/DC Voltage (V)	600	600	
	Max current with rated cross-section (A)	20	24	
	Section Min - Max (AWG)	20-12	20-10	
	Tightening torque (lb.in)	3,5	4,4	
Rated impulse withstand voltage/pollution degree		6 KV / 3	6 KV / 3	
Insulation stripping length (mm)		9	10	
Tightening torque value Nominal / Max (Nm)		0,4 / 0,6	0,5 / 0,8	
Length (mm)		57	57	
Width (mm)		5	6	
Height mounted on TH35/7,5 (mm)		52	52	
Height mounted on TH35/15 (mm)		60	60	
Height mounted on G32 (mm)		-	-	
Insulation material temperature index (EN 60216-1) (°C)		130	130	
Plastic material		polyamide UL94V-0	polyamide UL94V-0	

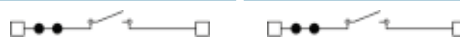

APPROVALS



ACCESSORIES

End section	Grey	CBSF.2-4/PT/GR (cod. CB401GR)	CBSF.2-4/PT/GR (cod. CB401GR)
	Beige	CBSF.2-4/PT (cod. CB401)	CBSF.2-4/PT (cod. CB401)
	Blue	CBSF.2-4/PT (Ex)I (cod. CB402)	CBSF.2-4/PT (Ex)I (cod. CB402)
	Thickness (mm)	1,5	1,5
Cross connection	PTC version (1)	PTC/2/... (cod. PTC02...)	PTC/4/... (cod. PTC04...)
	PTP version (1)	PTP/2/... (cod. PTP02...)	PTP/4/... (cod. PTP04...)
	Rated current (A)	24	32
Switchable cross connection		-	-
Cross connection identification strip	green	PTC/SP (cod. PTC0990)	PTC/SP (cod. PTC0990)
Multiple common bar		-	-
Shunting screw and sleeve		-	-
Coloured partition	red	DFU/3/R (cod. DU03R)	DFU/3/R (cod. DU03R)
Cross connection barrier	red	DFM/800 (cod. DF800) - DFM/900 (cod. DF900)	DFM/800 (cod. DF800) - DFM/900 (cod. DF900)
Test plug		-	-
Short-circuit plate	2 poles	-	-
	4 poles	-	-
Brass conducting element		-	-
Screw and sleeve for short-circuit plates		-	-
MSM handle		-	-
Marking tag		CNU/8/51 (cod. NU0851S)	CNU/8/51 (cod. NU0851S)
		CNU/10/61 (cod. NU1061S)	CNU/10/61 (cod. NU1061S)
	Snap-fit TH35 and G32	BTU (cod. BT005)	BTU (cod. BT005)
End bracket	Snap-fit TH35	BTO (cod. BT007)	BTO (cod. BT007)
	Screw TH35	BT/3 (cod. BT003)	BT/3 (cod. BT003)
	Screw G32	BT/DIN/PO (cod. BT001)	BT/DIN/PO (cod. BT001)



(1) See chapter accessories for more details

GREY VERSION	CODE TYPE	MP950GR MPS.4/GR	DS400GR DSS.4/GR
BEIGE VERSION	CODE TYPE	MP950 MPS.4	DS400 DSS.4
BLUE VERSION	CODE TYPE	MP960 MPS.4/SW [EX]	

TECHNICAL CHARACTERISTICS

Function/type		"blade" switchable	2 levels disconnect
Rated cross-section	(mm ²)	4	4
Connecting capacity	Flexible (mm ²)	0,2 ÷ 6	0,2 ÷ 6
	Rigid (mm ²)	0,2 ÷ 6	0,2 ÷ 6
	Max. flexible with ferrule - ferrule type (mm ²)	4 - WP40/16	4 - WP40/16
Electrical characteristics According to European standard IEC EN 60947-7-1	Max AC/DC Voltage (V)	400	400
	Max current with rated cross-section (A)	24	24(upper circuit)-32(lower circuit)
	Section (Caliber)	A4	A4
Electrical characteristics According to UL	Max AC/DC Voltage (V)	600	300
	Max current with rated cross-section (A)	24	24(upper circuit)-32(lower circuit)
	Section Min - Max (AWG)	26-10	26-10
	Tightening torque (lb.in)	4,4	4,4
Rated impulse withstand voltage/pollution degree		6 KV / 3	6 KV / 3
Insulation stripping length	(mm)	9	9
Tightening torque value Nominal / Max	(Nm)	0,5 / 1,2	0,5 / 1,2
Length	(mm)	47	78
Width	(mm)	6	6
Height mounted on TH35/7,5	(mm)	47	68
Height mounted on TH35/15	(mm)	55	75
Height mounted on G32	(mm)	51	72
Insulation material temperature index (EN 60216-1)	(°C)	130	130
Plastic material		polyamide UL94V-0	polyamide UL94V-0

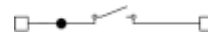

APPROVALS



ACCESSORIES			
End section	Grey	MPS.4/PT/GR (cod. MP901GR)	DSS/PT/GR (cod. DS301GR)
	Beige	MPS.4/PT (cod. MP901)	DSS/PT (cod. DS301)
	Blue	MPS.4/PT [Ex] i (cod. MP902)	-
	Thickness (mm)	1,5	1,5
Cross connection	PTC version (1)	PTC/4/... (cod. PTC04...)	PTC/4/... (cod. PTC04...)
	PTP version (1)	-	-
	Rated current (A)	32	32
Switchable cross connection		-	-
Cross connection identification strip	green	PTC/SP (cod. PTC0990)	PTC/SP (cod. PTC0990)
Multiple common bar		-	-
Shunting screw and sleeve		-	-
Coloured partition	red	DFU/3/R (cod. DU03R)	DFU/7/R (cod. DU07R)
Cross connection barrier	red	DFM/500 (cod. DF500)	DFM/500 (cod. DF500)
Test plug		-	-
Short-circuit plate	2 poles	-	-
	4 poles	-	-
Brass conducting element		-	-
Screw and sleeve for short-circuit plates		-	-
MSM handle		-	-
Marking tag		CNU/8/51 (cod. NU0851S)	CNU/8/51 (cod. NU0851S)
		CNU/10/61 (cod. NU1061S)	CNU/10/61 (cod. NU1061S)
	Snap-fit TH35 and G32	BTU (cod. BT005)	BTU (cod. BT005)
End bracket	Snap-fit TH35	BTO (cod. BT007)	BTO (cod. BT007)
	Screw TH35	BT/3 (cod. BT003)	BT/3 (cod. BT003)
	Screw G32	BT/DIN/PO (cod. BT001)	BT/DIN/PO (cod. BT001)

- disconnects by means of conducting element to be inserted in the lever
- disconnects with special connections
- Ø 5 x 20 mm CO/5 conducting element - in tin plated brass to be inserted in the lever



(1) See chapter accessories for more details

GREY VERSION	CODE	SF900GR	SF910GR
	TYPE	SFR.4/GR	SFR.4/VS/GR
BEIGE VERSION	CODE	SF900	SF910
	TYPE	SFR.4	SFR.4/VS
BLUE VERSION	CODE	SF850	
	TYPE	SFR.4 [EXI]	

TECHNICAL CHARACTERISTICS

Function/type		disconnect	disconnect, with solder lug
Rated cross-section	(mm ²)	4	4
Connecting capacity	Flexible (mm ²)	0,2 ÷ 6	0,2 ÷ 6
	Rigid (mm ²)	0,2 ÷ 6	0,2 ÷ 6
	Max. flexible with ferrule - ferrule type (mm ²)	4 - WP40/16	4 - WP40/16
Electrical characteristics According to European standard IEC EN 60947-7-1	Max AC/DC Voltage (V)	800	400
	Max current with rated cross-section (A)	20 A (with CO/5)	15 A (with CO/5)
	Section Caliber	A3	A4
Electrical characteristics According to UL	Max AC/DC Voltage (V)	600	-
	Max current with rated cross-section (A)	6,3	-
	Section Min - Max (AWG)	20-12	-
	Tightening torque (lb.in)	4,4	-
Rated impulse withstand voltage/pollution degree		6 KV / 3	4 KV / 3
Insulation stripping length (mm)		11	11
Tightening torque value Nominal / Max (Nm)		0,5 / 1,2	0,5 / 1,2
Length (mm)		52	65
Width (mm)		8	8
Height mounted on TH35/7,5 (mm)		52	52
Height mounted on TH35/15 (mm)		60	60
Height mounted on G32 (mm)		56	56
Insulation material temperature index (EN 60216-1) (°C)		130	130
Plastic material		polyamide UL94V-0	polyamide UL94V-0



APPROVALS

ACCESSORIES			
End section	Grey	SFR.4/PT/GR (cod. SF701GR)	SFR.4/PT/GR (cod. SF701GR)
	Beige	SFR.4/PT (cod. SF701)	SFR.4/PT (cod. SF701)
	Blue	SFR.4/PT [Ex]i (cod. SF801)	-
	Thickness (mm)	1,5	1,5
Cross connection	PTC version (1)	-	-
	PTP version (1)	-	-
	Rated current (A)	-	-
Switchable cross connection		-	-
Cross connection identification strip	green	-	-
Multiple common bar		-	-
Shunting screw and sleeve		-	-
Coloured partition	red	-	-
Cross connection barrier	red	-	-
Test plug		-	-
Short-circuit plate	2 poles	-	-
	4 poles	-	-
Brass conducting element		CO/5 (cod. VL103)	CO/5 (cod. VL103)
Screw and sleeve for short-circuit plates		-	-
MSM handle		-	-
Marking tag		CNU/8/51 (cod. NU0851S)	CNU/8/51 (cod. NU0851S)
		CNU/10/61 (cod. NU1061S)	CNU/10/61 (cod. NU1061S)
	Snap-fit TH35 and G32	BTU (cod. BT005)	BTU (cod. BT005)
End bracket	Snap-fit TH35	BTO (cod. BT007)	BTO (cod. BT007)
	Screw TH35	BT/3 (cod. BT003)	BT/3 (cod. BT003)
	Screw G32	BT/DIN/PO (cod. BT001)	BT/DIN/PO (cod. BT001)

- disconnects by means of conducting element to be inserted in the lever
- disconnects with special connections
- possibly to perform parallel connections
- Ø 6 x 32 mm CO/6 conducting element - in tin plated brass to be inserted in the lever



(1) See chapter accessories for more details

GREY VERSION	CODE TYPE	SR500GR SFR.6/M/GR	SR300GR SFR.6/GR
BEIGE VERSION	CODE TYPE	SR500 SFR.6/M	SR300 SFR.6
BLUE VERSION	CODE TYPE	SR600 SFR.6/M [EX]I	SR400 SFR.6 [EX]I

TECHNICAL CHARACTERISTICS

Function/type		SR500GR	SR300GR
Rated cross-section	(mm ²)	6	6
Connecting capacity	Flexible	0,2 ÷ 10	0,2 ÷ 10
	Rigid	0,2 ÷ 10	0,2 ÷ 10
	Max. flexible with ferrule - ferrule type	4 - WP60/20	6 - WP60/20
Electrical characteristics According to European standard IEC EN 60947-7-1	Max AC/DC Voltage	630	630
	Max current with rated cross-section	10 / 19 A (with cylinder)	10 / 32 A (with cylinder)
	Section	Caliber A5	A5
Electrical characteristics According to UL	Max AC/DC Voltage	600	600
	Max current with rated cross-section	6.3	10
	Section Min - Max	20-8	20-8
Tightening torque	(lb.in)	13	13
Rated impulse withstand voltage/pollution degree		6 KV / 3	6 KV / 3
Insulation stripping length	(mm)	11	11
Tightening torque value Nominal / Max	(Nm)	0,8 / 1,4	0,8 / 1,4
Length	(mm)	79	79
Width	(mm)	10	10
Height mounted on TH35/7,5	(mm)	59	59
Height mounted on TH35/15	(mm)	67	67
Height mounted on G32	(mm)	63	63
Insulation material temperature index (EN 60216-1)	(°C)	130	130
Plastic material		polyamide UL94V-0	polyamide UL94V-0



APPROVALS



ACCESSORIES		SR500GR	SR300GR
End section	Grey	SFR.6/PT/GR (cod. SR301GR)	SFR.6/PT/GR (cod. SR301GR)
	Beige	SFR.6/PT (cod. SR301)	SFR.6/PT (cod. SR301)
	Blue	SFR.6/PT [Ex]i (cod. SR401)	SFR.6/PT [Ex]i (cod. SR401)
	Thickness	(mm) 1,5	1,5
Cross connection	PTC version (1)	PTC/20/... (cod. PTC20...)	PTC/20/... (cod. PTC20...)
	PTP version (1)	-	-
	Rated current	(A) 25	25
Switchable cross connection		-	-
Cross connection identification strip	green	PTC/SP (cod. PTC0990)	PTC/SP (cod. PTC0990)
Multiple common bar		-	-
Shunting screw and sleeve		-	-
Coloured partition	red	DFU/7/R (cod. DU07R)	DFU/7/R (cod. DU07R)
Cross connection barrier	red	DFM/300 (cod. DF300)	DFM/300 (cod. DF300)
Test plug		SDD/1 (cod. DD001)	SDD/1 (cod. DD001)
Short-circuit plate	2 poles	-	-
	4 poles	-	-
Brass conducting element		CO/5 (cod. VL103)	CO/6 (cod. CO06)
Screw and sleeve for short-circuit plates		-	-
MSM handle		-	-
Marking tag		CNU/8/51 (cod. NU0851S)	CNU/8/51 (cod. NU0851S)
		CNU/10/61 (cod. NU1061S)	CNU/10/61 (cod. NU1061S)
	Snap-fit TH35 and G32	BTU (cod. BT005)	BTU (cod. BT005)
End bracket	Snap-fit TH35	BTO (cod. BT007)	BTO (cod. BT007)
	Screw TH35	BT/3 (cod. BT003)	BT/3 (cod. BT003)
	Screw G32	BT/DIN/PO (cod. BT001)	BT/DIN/PO (cod. BT001)

- disconnects by means of conducting element to be inserted in the lever
- slide link disconnect
- possibly to perform parallel connections
- Ø 6x 32 mm CO/6 conducting element - in tin plated brass to be inserted in the lever



(1) See chapter accessories for more details

GREY VERSION	CODE TYPE		SB300GR
			SCB.4/GR
BEIGE VERSION	CODE TYPE	FP100	SB300
		FPC.10	SCB.4
BLUE VERSION	CODE TYPE		

TECHNICAL CHARACTERISTICS

Function/type		disconnect	disconnect by slide link
Rated cross-section	(mm ²)	10	4
Connecting capacity	Flexible	1,5 ÷ 16	0,2 ÷ 6
	Rigid	1,5 ÷ 16	0,2 ÷ 6
	Max. flexible with ferrule - ferrule type	10 - WP100/21	4 - WP40/16
Electrical characteristics According to European standard IEC EN 60947-7-1	Max AC/DC Voltage	800	800
	Max current with rated cross-section	20 (with SFC/CO)	32
	Section	Caliber B6	A4
Electrical characteristics According to UL	Max AC/DC Voltage	600	600
	Max current with rated cross-section	15	20
	Section Min - Max	(AWG) 20-6	20-12
	Tightening torque	(lb.in) 7	4,4
Rated impulse withstand voltage/pollution degree		6 KV / 3	8 KV / 3
Insulation stripping length	(mm)	17	9
Tightening torque value Nominal / Max	(Nm)	1,2 / 1,9	0,5 / 1,2
Length	(mm)	63	58
Width	(mm)	12	6,5
Height mounted on TH35/7,5	(mm)	70	44
Height mounted on TH35/15	(mm)	79	52
Height mounted on G32	(mm)	75	48
Insulation material temperature index (EN 60216-1)	(°C)	130	130
Plastic material		polyamide UL94V-0	polyamide UL94V-0



APPROVALS



ACCESSORIES			
End section	Grey	-	SCB.4/PT/GR (cod. SB301GR)
	Beige	-	SCB.4/PT (cod. SB301)
	Blue	-	-
Cross connection	Thickness (mm)	1,5	1,5
	PTC or other version (1)	-	PM/40/... (cod. PM4...)
	PTP version (1)	-	32
Switchable cross connection	Rated current (A)	-	POS/12 (cod. POS12)
Cross connection identification strip	green	-	-
Multiple common bar		-	PMP/42 (cod. PMP42)
Shunting screw and sleeve		-	CPM/12 (cod. CPM12)
Coloured partition	red	DFU/6/R (cod. DU06R)	DFU/3/R (cod. DU03R)
Cross connection barrier	red	-	-
Test plug		SDD/2 (cod. DD002)	SDD/6-SDD/1 (cod. DD006-DD001)
Short-circuit plate	2 poles	-	SCB/4/PO/2 (cod. SB303)
	4 poles	-	SCB/4/PO/4 (cod. SB304)
Brass conducting element		SFC/CO (cod. FC102)	-
Screw and sleeve for short-circuit plates		-	SCB/4/CPM (cod. SB305)
MSM handle		MSM (cod. FC103)	-
Marking tag		CNU/8/51 (cod. NU0851S)	CNU/8/51 (cod. NU0851S)
		CNU/10/61 (cod. NU1061S)	CNU/10/61 (cod. NU1061S)
	Snap-fit TH35 and G32	BTU (cod. BT005)	BTU (cod. BT005)
End bracket	Snap-fit TH35	BTO (cod. BT007)	BTO (cod. BT007)
	Screw TH35	BT/3 (cod. BT003)	BT/3 (cod. BT003)
	Screw G32	BT/DIN/PO (cod. BT001)	BT/DIN/PO (cod. BT001)

WITH UL94V-0 POLYAMIDE INSULATING BODY

- Universal mounting for both PR/DIN and PR/3 rails which meet IEC 60715 norms, "G32" and TH/35 types

In SCB.6 type terminal block, the use of special cross-connections, formed by

SCB/6/PO/2

(between 2 adjoining terminal blocks)



or

SCB/6/PO/4

(between 4 adjoining terminal blocks)



and by the relevant

SCB/6/CPM

shunting screws



allow the simultaneous earth connection of the current transformers connected to the terminal blocks themselves, guaranteeing the correct operational sequence. In fact such cross connections, in opened position, avoid the translation on the slide links, already connected in an accident prevention position from the outside; they do not require the insertion of further partitions to separate them from other adjoining cross-connections or terminal blocks, due to the special shape of the insulating body of the terminal block itself.

SCB.6 type terminal blocks have also the possibility to house, upstream and downstream the disconnection, sockets for test plugs, suitable for the withdraw of signals.

In particular the shunts can take place:

- On **SCB/CPM** shunting screws of the short-circuit plates
- On **PSD/P** socket to be screwed directly into the conducting body of the terminal block, in order to perform the shunting function.

The slide-link is formed by two guides, held together by a screw inserted in a glass-shape collar, which allows the elastic blocking and the anti-loosening of the slide-link and is provided with a red protective colouring for the easy positioning of the screwdriver during the disconnection and the easy spotting of the slide-link itself.

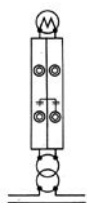

**NORMAL
OPERATION**

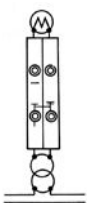

**CT
SHORT-CIRCUIT**

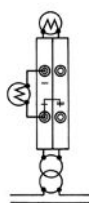

**TEST ON
MEASURING
INSTRUMENT**

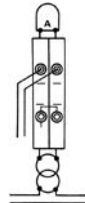

**PROTECTION
INSTRUMENT
TEST**

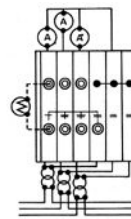

**THREE PHASE
CT TEST**



- configurations prepared /DD (with derivation sockets upstream and downstream of the slide link) - for voltammetric circuits
- configurations prepared /CD (with derivation sockets upstream and downstream of the slide link and sleeve for short circuit upstream of the slide link) - for amperometric circuits

- (1) For the simple connection in parallel of two or more adjoining terminal blocks use the parallel skid, with the screw and sleeves, after removing the insulating wall with a simple cutter.
 (2) Longitudinal and trasversal test switching terminal block. Configuration complete with test plug socket downstream and upstream the slide link, compliant with the ENEL LV 27/3 specifications.
 (3) Longitudinal and trasversal test switching terminal block. Configuration complete with test plug socket upstream and a short circuit sleeve SCB/6/PO/2 or SCB/6/PO/4 type, supplied separately, downstream of the slide link, compliant with the ENEL LV 27/3 specifications.



GREY VERSION	CODE	SB200GR	SB210GR	SB220GR
BEIGE VERSION	CODE	SB200	SB210	SB220
	TYPE	SCB.6/GR	SCB.6/DD/GR	SCB.6/CD/GR
	TYPE	SCB.6	SCB.6/DD	SCB.6/CD

TECHNICAL CHARACTERISTICS

Function/type		SB200GR	SB210GR	SB220GR
disconnect by slide link				
disconnect by slide link in special configuration for voltmetric circuits [2]				
disconnect by slide link in special configuration for amperometric circuits [3]				
Rated cross-section	(mm ²)	6	6	6
Connecting capacity	Flexible	(mm ²) 0.5-10	(mm ²) 0.5-10	(mm ²) 0.5-10
	Rigid	(mm ²) 0.5-10	(mm ²) 0.5-10	(mm ²) 0.5-10
	Max. flexible with ferrule - ferrule type	(mm ²) 6-WP60/20	(mm ²) 6-WP60/20	(mm ²) 6-WP60/20
Electrical characteristics According to European standard IEC EN 60947-7-1	Max AC/DC Voltage	(V) 800	(V) 800	(V) 800
	Max current with rated cross-section	(A) 41	(A) 41	(A) 41
Electrical characteristics According to UL	Section	Caliber A5	Caliber A5	Caliber A5
	Max AC/DC Voltage	(V) 600	-	-
	Max current with rated cross-section	(A) 47	-	-
	Section Min - Max	(AWG) 20 - 8	-	-
Tightening torque	(lb.in) 13.3	-	-	-
Rated impulse withstand voltage/pollution degree		8 KV / 3	8 KV / 3	8 KV / 3
Insulation stripping length	(mm)	12	12	12
Tightening torque value (test / max)	(Nm)	0.8 / 1.4	0.8 / 1.4	0.8 / 1.4
Length	(mm)	69	69	69
Width	(mm)	8	8	8
Height mounted on TH35/7,5	(mm)	65	76	77
Height mounted on TH35/15	(mm)	73	84	85
Height mounted on G32	(mm)	68	79	80
Insulation material temperature index (EN 60216-1)	(°C)	130	130	130
Plastic material		polyamide UL94V-0	polyamide UL94V-0	polyamide UL94V-0

APPROVALS



ACCESSORIES		SB200GR	SB210GR	SB220GR
End section	Grey	SCB/6/PT/GR (cod. SB201GR)	SCB/6/PT/GR (cod. SB201GR)	SCB/6/PT/GR (cod. SB201GR)
	Beige	SCB/6/PT (cod. SB201)	SCB/6/PT (cod. SB201)	SCB/6/PT (cod. SB201)
	Thickness (mm)	1.5	1.5	1.5
Permanent cross connection	(1)	POF/57 (cod. POF57)	POF/57 (cod. POF57)	POF/57 (cod. POF57)
Multiple common bar	250 mm	PMP/13 (cod. PMP13)	PMP/13 (cod. PMP13)	PMP/13 (cod. PMP13)
Shunting screw and sleeve		CPM/57 (cod. CPM57)	CPM/57 (cod. CPM57)	CPM/57 (cod. CPM57)
Coloured partition	red	DFU/6/R (cod. DU06R)	DFU/6/R (cod. DU06R)	DFU/6/R (cod. DU06R)
Test plug socket		PSD/P (cod. PD015)	2 pcs included	1 pcs included
Test plug		SDD/2 (cod. DD002)	SDD/2 (cod. DD002)	SDD/2 (cod. DD002)
	2 poles	SCB/6/PO/2 (cod. SB203)	-	SCB/6/PO/2 (cod. SB203)
	4 poles	SCB/6/PO/4 (cod. SB204)	-	SCB/6/PO/4 (cod. SB204)
Screw and sleeve for short-circuit plates	black	SCB/6/CPM (cod. SB205)	-	1 pcs included
	red	SCB/6/CPM/R (cod. SB205R)	-	-
Marking tag		CNU/8/51 (cod. NU0851S)	CNU/8/51 (cod. NU0851S)	CNU/8/51 (cod. NU0851S)
		CNU/10/61 (cod. NU1061S)	CNU/10/61 (cod. NU1061S)	CNU/10/61 (cod. NU1061S)
End bracket	Snap-fit TH35 and G32	BTU (cod. BT005)	BTU (cod. BT005)	BTU (cod. BT005)
	Snap-fit TH35	BTO (cod. BT007)	BTO (cod. BT007)	BTO (cod. BT007)
	Screw TH35	BT/3 (cod. BT003)	BT/3 (cod. BT003)	BT/3 (cod. BT003)
	Screw G32	BT/DIN/PO (cod. BT001)	BT/DIN/PO (cod. BT001)	BT/DIN/PO (cod. BT001)

- configurations prepared /DD (with derivation sockets upstream and downstream of the slide link) - for voltammetric circuits
- configurations prepared /CD (with derivation sockets upstream and downstream of the slide link and sleeve for short circuit upstream of the slide link) - for amperometric circuits



GREY VERSION	CODE TYPE	SB400GR SCB.10/GR	SB410GR SCB.10/DD/GR	SB420GR SCB.10/CD/GR
BEIGE VERSION	CODE TYPE	SB400 SCB.10	SB410 SCB.10/DD	SB420 SCB.10/CD

TECHNICAL CHARACTERISTICS

Function/type					
Rated cross-section	[mm ²]	10	10	10	
Connecting capacity	Flexible	[mm ²]	0.5-16	0.5-16	
	Rigid	[mm ²]	0.5-16	0.5-16	
	Max. flexible with ferrule - ferrule type	[mm ²]	10-WP100/21	10-WP100/21	10-WP100/21
Electrical characteristics According to European standard IEC EN 60947-7-1	Max AC/DC Voltage	[V]	1000	1000	
	Max current with rated cross-section	[A]	57	57	57
Electrical characteristics According to UL	Section	Caliber	B6	B6	B6
	Max AC/DC Voltage	[V]	-	-	-
	Max current with rated cross-section	[A]	-	-	-
	Section Min - Max	[AWG]	-	-	-
	Tightening torque	[lb.in]	-	-	-
Rated impulse withstand voltage/pollution degree		8 KV / 3	8 KV / 3	8 KV / 3	
Insulation stripping length	[mm]	14	14	14	
Tightening torque value (test / max)	[Nm]	1,2 / 1,9	1,2 / 1,9	1,2 / 1,9	
Length	[mm]	75	-	-	
Width	[mm]	10.5	10.5	10.5	
Height mounted on TH35/7,5	[mm]	59.5	59.5	59.5	
Height mounted on TH35/15	[mm]	67.5	67.5	67.5	
Height mounted on G32	[mm]	63.5	63.5	63.5	
Insulation material temperature index (EN 60216-1)	[°C]	130	130	130	
Plastic material		polyamide UL94V-0	polyamide UL94V-0	polyamide UL94V-0	

APPROVALS



ACCESSORIES

End section	Grey	SCB/10/PT/GR (cod. SB401GR)	SCB/10/PT/GR (cod. SB401GR)	SCB/10/PT/GR (cod. SB401GR)
	Beige	SCB/10/PT (cod. SB401)	SCB/10/PT (cod. SB401)	SCB/10/PT (cod. SB401)
	Thickness	[mm]	1.5	1.5
Permanent cross connection	(1)	POF/56 (cod. POF56)	POF/56 (cod. POF56)	POF/56 (cod. POF56)
Multiple common bar	250 mm	PMP/56 (cod. PMP56)	PMP/56 (cod. PMP56)	PMP/56 (cod. PMP56)
Shunting screw and sleeve		CPM/56 (cod. CPM56)	CPM/56 (cod. CPM56)	CPM/56 (cod. CPM56)
Coloured partition	red	DFU/7/R (cod. DU07R)	DFU/7/R (cod. DU07R)	DFU/7/R (cod. DU07R)
Test plug socket		PSD/L PD009	2 pcs included	1 pcs included
Test plug		SDD/2 (cod. DD002)	SDD/2 (cod. DD002)	SDD/2 (cod. DD002)
	2 poles	SCX/PO/2 (cod. SC103)	-	SCX/PO/2 (cod. SC103)
	4 poles	SCX/PO/4 (cod. SC104)	-	SCX/PO/4 (cod. SC104)
Screw and sleeve for short-circuit plates	black	SCX/CPM (cod. SC105)	-	1 pcs included
	red	-	-	-
Marking tag		CNU/8/51 (cod. NU0851S)	CNU/8/51 (cod. NU0851S)	CNU/8/51 (cod. NU0851S)
		CNU/10/61 (cod. NU1061S)	CNU/10/61 (cod. NU1061S)	CNU/10/61 (cod. NU1061S)
End bracket	Snap-fit TH35 and G32	BTU (cod. BT005)	BTU (cod. BT005)	BTU (cod. BT005)
	Snap-fit TH35	BTO (cod. BT007)	BTO (cod. BT007)	BTO (cod. BT007)
	Screw TH35	BT/3 (cod. BT003)	BT/3 (cod. BT003)	BT/3 (cod. BT003)
	Screw G32	BT/DIN/PO (cod. BT001)	BT/DIN/PO (cod. BT001)	BT/DIN/PO (cod. BT001)

- for 1 A diodes (types 1N4001 – 1N4007)
- for 3 A diodes (type BY 255)



(1) value referred to the insulation characteristics of the terminal block

GREY VERSION	CODE TYPE	SF900GR	SF901GR	SF903GR
		SFR.4/GR	SFR.4/D1/GR	SFR.4/D3/GR
BEIGE VERSION	CODE TYPE	SF900	SF901	SF903
		SFR.4	SFR.4/D1	SFR.4/D3

TECHNICAL CHARACTERISTICS

Function/type		for 1 A or 3 A diodes	with 1 A diode	with 3 A diode
Rated cross-section	[mm ²]	4	4	4
Connecting capacity	Flexible	0.2-6	0.2-6	0.2-6
	Rigid	0.2-6	0.2-6	0.2-6
	Max. flexible with ferrule - ferrule type	4-WP40/16	4-WP40/16	4-WP40/16
Electrical characteristics According to European standard IEC EN 60947-7-1	Max AC/DC Voltage	800 (1)	800 (1)	800 (1)
	Max current with rated cross-section	1 / 3	1	3
	Section	Caliber A4	A4	A4
Rated impulse withstand voltage/pollution degree		6 KV (1) / 3	6 KV (1) / 3	6 KV (1) / 3
Insulation stripping length	(mm)	11	11	11
Tightening torque value (test / max)	(Nm)	0.5 / 1.2	0.5 / 1.2	0.5 / 1.2
Length	(mm)	52	52	52
Width	(mm)	8	8	8
Height mounted on TH35/7,5	(mm)	52	52	52
Height mounted on TH35/15	(mm)	60	60	60
Height mounted on G32	(mm)	56	56	56
Insulation material temperature index (EN 60216-1)	(°C)	130	130	130
Plastic material		polyamide UL94V-0	polyamide UL94V-0	polyamide UL94V-0

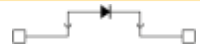
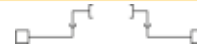

APPROVALS



ACCESSORIES				
End section	Grey	SFR.4/PT/GR (cod. SF701GR)	SFR.4/PT/GR (cod. SF701GR)	SFR.4/PT/GR (cod. SF701GR)
	Beige	SFR.4/PT (cod. SF701)	SFR.4/PT (cod. SF701)	SFR.4/PT (cod. SF701)
	Blue	SFR.4/PT (Ex)I (cod. SF801)	SFR.4/PT (Ex)I (cod. SF801)	SFR.4/PT (Ex)I (cod. SF801)
	Thickness	(mm) 1.5	1.5	1.5
Coloured partition	red	DFU/3/R (cod. DU03R)	DFU/3/R (cod. DU03R)	DFU/3/R (cod. DU03R)
Miniature fuse		-	F5 (cod. FN...)	F5 (cod. FN...)
Cartridge / insert with 1 A diode		SFR/1A (cod. SF992)	-	-
Cartridge / insert with 3 A diode		SFR/3A (cod. SF993)	-	-
Marking tag		CNU/8/51 (cod. NU0851S)	CNU/8/51 (cod. NU0851S)	CNU/8/51 (cod. NU0851S)
		CNU/10/61 (cod. NU1061S)	CNU/10/61 (cod. NU1061S)	CNU/10/61 (cod. NU1061S)
End bracket	Snap-fit TH35 and G32	BTU (cod. BT005)	BTU (cod. BT005)	BTU (cod. BT005)
	Snap-fit TH35	BTO (cod. BT007)	BTO (cod. BT007)	BTO (cod. BT007)
	Screw TH35	BT/3 (cod. BT003)	BT/3 (cod. BT003)	BT/3 (cod. BT003)
	Screw G32	BT/DIN/PO (cod. BT001)	BT/DIN/PO (cod. BT001)	BT/DIN/PO (cod. BT001)

SCREW CLAMP

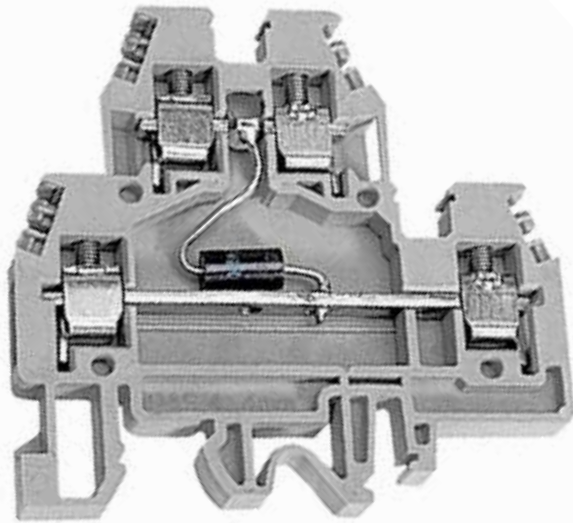

- With cross-connection possibility
- Universal mounting onto both PR/DIN and PR/3 type rails - according to IEC 60715 standard
- Two and three level circuits with bidirectional suppressor diode
- Protection against overvoltage, transient, pulse jamming
- Class D protection according to standard DIN VDE 0675. 1989
- Overvoltage category <math><1.5\text{ kV, I}</math> (DIN VDE 0110.1)
- Available in grey and beige

The **DAS.4...D** terminal blocks with suppressor diodes inserted as in **diagram 3**, limit voltage peaks due to surges, electrostatic discharges and switching of inductive loads, and enable the equipment to pass the tests on immunity to electromagnetic interferences defined by the EN 61000-4-2 (Electrostatic discharge), EN 61000-4-4 (Fast Transient/Burst) and EN 61000-4-5 (Surge Test) Standards. The suppressor diodes have an intervention time (<math><1\text{ ns}</math>) much faster than the intervention time of varistors (approximately 25 ns) and a lower and more precise intervention voltage, but compared to these withstand lower discharge currents.

The great precision of the intervention voltage and the great speed, makes them suitable for protecting industrial PLC, DCS, PC I/O signal ports, against voltage interferences and discharge currents lower than 500A impulse 8/20 μs . This type of interference is usually caused by the normal operation of the plants themselves, owing to the switching of strong inductive loads, dispersed currents, faults, etc...

The range of models available makes it possible to choose between nominal voltages suitable for protecting signals with standard voltages of 5Vdc, 12Vdc, 24Vdc and 60Vdc. The **DAS.4...D** connected as in **diagram 4** is an effective protection against differential mode interferences for industrial PLC, DCS, PC inputs and outputs, signal conditioners and sensors, and also for stabilised direct current power supplies of electronic equipment in general.

The **DAS.4...D** does not have a signal wiring direction to be observed, as also the connection of the positive and negative polarities can be made either on the lower or the upper level.

Differential mode interference (diagram 5): these generate a great difference of potential between the two conductors of a signal (positive and negative of the twisted pair) or of a power supply, and as they are applied directly to the input/output circuits of the device, they always cause a fault in the same.

Common mode interference (diagram 6): these generate a great difference of potential between the two signal or power supply conductors and the reference earth. They are less destructive than differential mode interferences.

Caution: inserting surge protection devices with varistors, diodes and other components between the signal and/or power supply conductors and the protection earth reduces the insulation voltage approximately to the V breakdown value of the discharger used; to perform insulation tests on the equipment, disconnect the dischargers (IEC EN 60950 Standard).

Note for wiring: wiring of the power surge protection devices greatly influences their actual efficacy and we recommend following the instructions below:

- The protection device must be placed as close as possible to the equipment to be protected;
- The connection wires must be as short and straight as possible, interwoven with each other and with the largest possible cross section;
- The earth conductors between common mode dischargers and the equipotential busbar must be as short as possible and with the largest possible cross section and their path must not be parallel to other conductors. The earth of the protected equipment must be connected to the same earth of its discharger and from there to the general protection earthing.



Schema 3

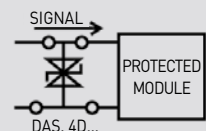

Diagram 4

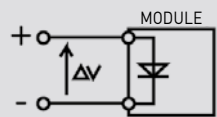

Diagram 5

Differential mode interference. The potential difference is applied between positive and negative poles of the power supply signal.

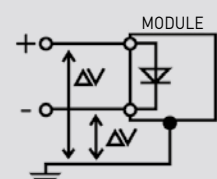
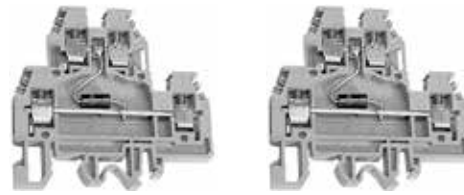

Diagram 6

Common mode interference. The potential difference is applied between the poles of the signal/power supply unit and the earth.

- with cross-connection possibility on lower level
- two and three level circuits with bidirectional suppressor diode
- protection against overvoltage, transistor, pulse jamming
- class D protection according to standard DIN VDE 0675
- overvoltage category <1.5 kV, I (DIN VDE 0110.1)



[1] See chapter accessories for more details

GREY VERSION	CODE TYPE	DSD005GR DAS.4/D5/GR	DSD012GR DAS.4/D12/GR
BEIGE VERSION	CODE TYPE	DSD005 DAS.4/D5	DSD012 DAS.4/D12

TECHNICAL CHARACTERISTICS

Function/type		bidirectional suppressor	bidirectional suppressor
Rated cross-section	(mm ²)	4	4
Connecting capacity	Flexible (mm ²)	0.2-6	0.2-6
	Rigid (mm ²)	0.2-6	0.2-6
	Max. flexible with ferrule - ferrule type (mm ²)	4-WP40/16	4-WP40/16
Rated voltage	(V)	5	12
Vdc max.	(V)	6.45	15.2
Vac max.	(V)	-	-
Breakdown voltage(1 mA)	(V)	6.8 ± 5%	16 ± 5%
Max clamping voltage	(V)	11	23
Response time	(ns)	< 1	< 1
ISC pulse /20 µs	(A)	750	350
Capacity (1 kHz)	(nF)	5	3
Insulation stripping length	(mm)	9	9
Tightening torque value (test / max)	(Nm)	0.5 / 1.2	0.5 / 1.2
Length	(mm)	64	64
Width	(mm)	6	6
Height mounted on TH35/7,5	(mm)	62	62
Height mounted on TH35/15	(mm)	70	70
Height mounted on G32	(mm)	66	66
Insulation material temperature index (EN 60216-1)	(°C)	130	130
Plastic material		polyamide UL94V-0	polyamide UL94V-0

APPROVALS

ACCESSORIES

End section	Grey	DAS/PT/GR (cod. DS101GR)	DAS/PT/GR (cod. DS101GR)
	Beige	DAS/PT (cod. DS101)	DAS/PT (cod. DS101)
	Thickness (mm)	1.5	1.5
Cross connection	[1]	PM/.../... (cod. PM...)	PM/.../... (cod. PM...)
Switchable cross connection		POS/43 (cod. POS43)	POS/43 (cod. POS43)
Multiple common bar	250 mm	PMP/58 (cod. PMP58)	PMP/58 (cod. PMP58)
Shunting screw and sleeve		CPM/01 (cod. CPM01)	CPM/01 (cod. CPM01)
Coloured partition	red	DFU/7/R (cod. DU07R)	DFU/7/R (cod. DU07R)
Test plug socket		PSD/A (cod. PD001)	PSD/A (cod. PD001)
Test plug		SDD/1 (cod. DD001)	SDD/1 (cod. DD001)
Numbering strip		-	-
Cover for cross-connections		PRP/5 (cod. PRP05)	PRP/5 (cod. PRP05)
Marking tag		CNU/8/51 (cod. NU0851S)	CNU/8/51 (cod. NU0851S)
		CNU/10/61 (cod. NU1061S)	CNU/10/61 (cod. NU1061S)
		BTU (cod. BT005)	BTU (cod. BT005)
End bracket	Snap-fit TH35	BTO (cod. BT007)	BTO (cod. BT007)
	Screw TH35	BT/3 (cod. BT003)	BT/3 (cod. BT003)
	Screw G32	BT/DIN/PO (cod. BT001)	BT/DIN/PO (cod. BT001)

- with cross-connection possibility on lower level
- two and three level circuits with bidirectional suppressor diode
- protection against overvoltage, transistor, pulse jamming
- class D protection according to standard DIN VDE 0675
- overvoltage category <1.5 kV, I (DIN VDE 0110.1)

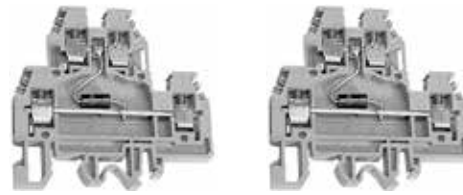

(1) See chapter accessories for more details

GREY VERSION	CODE TYPE	DSD024GR DAS.4/D24/GR	DSD060GR DAS.4/D60/GR
BEIGE VERSION	CODE TYPE	DSD024 DAS.4/D24	DSD060 DAS.4/D60

TECHNICAL CHARACTERISTICS

Function/type	bidirectional suppressor	bidirectional suppressor
Rated cross-section	[mm ²] 4	4
Connecting capacity	Flexible [mm ²] 0.2-6	0.2-6
	Rigid [mm ²] 0.2-6	0.2-6
	Max. flexible with ferrule - ferrule type [mm ²] 4-WP40/16	4-WP40/16
Rated voltage	[V] 24	60
Vdc max.	[V] 28.5	77.9
Vac max.	[V] -	-
Breakdown voltage(1 mA)	[V] 30 ± 5%	82 ± 5%
Max clamping voltage	[V] 41	113
Response time	[ns] < 1	< 1
ISC pulse /20 µs	[A] 160	70
Capacity [1 kHz]	[nF] 1.5	0.6
Insulation stripping length	[mm] 9	9
Tightening torque value (test / max)	[Nm] 0.5 / 1.2	0.5 / 1.2
Length	[mm] 64	64
Width	[mm] 6	6
Height mounted on TH35/7,5	[mm] 62	62
Height mounted on TH35/15	[mm] 70	70
Height mounted on G32	[mm] 66	66
Insulation material temperature index (EN 60216-1)	[°C] 130	130
Plastic material	polyamide UL94V-0	polyamide UL94V-0

APPROVALS

ACCESSORIES

End section	Grey	DAS/PT/GR (cod. DS101GR)	DAS/PT/GR (cod. DS101GR)
	Beige	DAS/PT (cod. DS101)	DAS/PT (cod. DS101)
	Thickness [mm]	1.5	1.5
Cross connection	[1]	PM/.../... (cod. PM...)	PM/.../... (cod. PM...)
Switchable cross connection		POS/43 (cod. POS43)	POS/43 (cod. POS43)
Multiple common bar	250 mm	PMP/58 (cod. PMP58)	PMP/58 (cod. PMP58)
Shunting screw and sleeve		CPM/01 (cod. CPM01)	CPM/01 (cod. CPM01)
Coloured partition	red	DFU/7/R (cod. DU07R)	DFU/7/R (cod. DU07R)
Test plug socket		PSD/A (cod. PD001)	PSD/A (cod. PD001)
Test plug		SDD/1 (cod. DD001)	SDD/1 (cod. DD001)
Numbering strip		-	-
Cover for cross-connections		PRP/5 (cod. PRP05)	PRP/5 (cod. PRP05)
Marking tag		CNU/8/51 (cod. NU0851S)	CNU/8/51 (cod. NU0851S)
		CNU/10/61 (cod. NU1061S)	CNU/10/61 (cod. NU1061S)
		BTU (cod. BT005)	BTU (cod. BT005)
End bracket	Snap-fit TH35	BTO (cod. BT007)	BTO (cod. BT007)
	Screw TH35	BT/3 (cod. BT003)	BT/3 (cod. BT003)
	Screw G32	BT/DIN/PO (cod. BT001)	BT/DIN/PO (cod. BT001)

- two and three level circuits with varistor
- with cross-connection possibility on lower level
- protection against overvoltage, transistor, pulse jamming
- class D protection according to DIN VDE 0675
- overvoltage category <2.5 kV, I (acc. to DIN VDE 0110.1)



[1] See chapter accessories for more details

GREY VERSION	CODE TYPE	DSV024GR	DSV048GR
		DAS.4/V24/GR	DAS.4/V48/GR
BEIGE VERSION	CODE TYPE	DSV024	DSV048
		DAS.4/V24	DAS.4/V48

TECHNICAL CHARACTERISTICS

Function/type		two level circuits with varistor	two level circuits with varistor
Rated cross-section	[mm ²]	4	4
Connecting capacity	Flexible [mm ²]	0.2-6	0.2-6
	Rigid [mm ²]	0.2-6	0.2-6
	Max. flexible with ferrule - ferrule type [mm ²]	4-WP40/16	4-WP40/16
Rated voltage	[V]	24	48
Vdc max.	[V]	31	85
Vac max.	[V]	25	60
Breakdown voltage(1 mA)	[V]	39 ± 10%	100 ± 10%
Max clamping voltage	[V]	77	165
Response time	[ns]	< 25	< 25
ISC pulse /20 µs	[A]	500	2500
Capacity [1 kHz]	[nF]	4600	1650
Insulation stripping length	[mm]	9	9
Tightening torque value (test / max)	[Nm]	0.5 / 1.2	0.5 / 1.2
Length	[mm]	64	64
Width	[mm]	6	6
Height mounted on TH35/7,5	[mm]	62	62
Height mounted on TH35/15	[mm]	70	70
Height mounted on G32	[mm]	66	66
Insulation material temperature index (EN 60216-1)	[°C]	130	130
Plastic material		polyamide UL94V-0	polyamide UL94V-0

The **DAS.4V...** terminal blocks with varistor inserted as in **diagram 1**, limit voltage peaks due to surges, indirect atmospheric discharges and switching of inductive loads, and enable the equipment to pass the tests on immunity to electromagnetic interferences defined by the EN 61000-4-2 (Electrostatic discharge), EN 61000-4-4 (Fast Transient/Burst) and EN 61000-4-5 (Surge Test) Standards.

Varistors have an intervention time [20-25 ns] much longer than the intervention time of suppressor diodes (<1 ns) and a higher intervention voltage, but compared to these withstand higher discharge currents. The high discharge current makes them suitable for use in the presence of strong transients, with currents of up to 4500 A impulse 8/20 s. The range of models available makes it possible to choose between nominal voltages suitable for protecting both signals and power supplies with standard voltages of 24 V DC, 48 V DC, or for power supply voltages of 120 V AC and 230 V AC.

APPROVALS

ACCESSORIES

End section	Grey	DAS/PT/GR (cod. DS101GR)	DAS/PT/GR (cod. DS101GR)
	Beige	DAS/PT (cod. DS101)	DAS/PT (cod. DS101)
	Thickness [mm]	1.5	1.5
Cross connection	[1]	PM/.../... (cod. PM...)	PM/.../... (cod. PM...)
Switchable cross connection		POS/43 (cod. POS43)	POS/43 (cod. POS43)
Multiple common bar	250 mm	PMP/58 (cod. PMP58)	PMP/58 (cod. PMP58)
Shunting screw and sleeve		CPM/01 (cod. CPM01)	CPM/01 (cod. CPM01)
Coloured partition	red	DFU/7/R (cod. DU07R)	DFU/7/R (cod. DU07R)
Test plug socket		PSD/A (cod. PD001)	PSD/A (cod. PD001)
Test plug		SDD/1 (cod. DD001)	SDD/1 (cod. DD001)
Numbering strip		-	-
Cover for cross-connections		PRP/5 (cod. PRP05)	PRP/5 (cod. PRP05)
Marking tag		CNU/8/51 (cod. NU0851S)	CNU/8/51 (cod. NU0851S)
		CNU/10/61 (cod. NU1061S)	CNU/10/61 (cod. NU1061S)
		BTU (cod. BT005)	BTU (cod. BT005)
End bracket	Snap-fit TH35 and G32	BTU (cod. BT005)	BTU (cod. BT005)
	Snap-fit TH35	BTO (cod. BT007)	BTO (cod. BT007)
	Screw TH35	BT/3 (cod. BT003)	BT/3 (cod. BT003)
	Screw G32	BT/DIN/PO (cod. BT001)	BT/DIN/PO (cod. BT001)



The **DAS.4V...** connected as in **diagram 2** is an effective protection against differential mode interferences for industrial PLC, DCS, PC inputs and outputs, signal conditioners and sensors, and also for power supplies of electronic equipment in general.

The **DAS.4V...** does not have a signal wiring direction to be observed, as also the connection of the positive and negative polarities can be made either on the lower or the upper level.

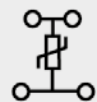

Diagram 1

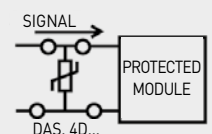
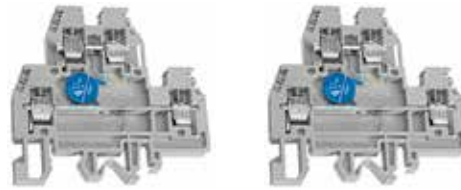

Diagram 2

- two and three level circuits with varistor
- with cross-connection possibility on lower level
- protection against overvoltage, transistor, pulse jamming
- class D protection according to DIN VDE 0675
- overvoltage category <2.5 kV, I (acc. to DIN VDE 0110.1)



[1] See chapter accessories for more details

GREY VERSION	CODE	DSV120GR	DSV230GR
	TYPE	DAS.4/V120/GR	DAS.4/V230/GR
BEIGE VERSION	CODE	DSV120	DSV230
	TYPE	DAS.4/V120	DAS.4/V230

TECHNICAL CHARACTERISTICS

Function/type		two level circuits with varistor	two level circuits with varistor
Rated cross-section	[mm ²]	4	4
Connecting capacity	Flexible [mm ²]	0.2-6	0.2-6
	Rigid [mm ²]	0.2-6	0.2-6
	Max. flexible with ferrule - ferrule type [mm ²]	4-WP40/16	4-WP40/16
Rated voltage	[V]	120	230
Vdc max.	[V]	180	350
Vac max.	[V]	140	275
Breakdown voltage(1 mA)	[V]	220 ± 10%	430 ± 10%
Max clamping voltage	[V]	360	710
Response time	[ns]	< 25	< 25
ISC pulse /20 µs	[A]	2500	2500
Capacity [1 kHz]	[nF]	610	320
Insulation stripping length	[mm]	9	9
Tightening torque value (test / max)	[Nm]	0.5 / 1.2	0.5 / 1.2
Length	[mm]	64	64
Width	[mm]	6	6
Height mounted on TH35/7,5	[mm]	62	62
Height mounted on TH35/15	[mm]	70	70
Height mounted on G32	[mm]	66	66
Insulation material temperature index (EN 60216-1)	[°C]	130	130
Plastic material		polyamide UL94V-0	polyamide UL94V-0

The **DAS.4V...** terminal blocks with varistor inserted as in **diagram 1**, limit voltage peaks due to surges, indirect atmospheric discharges and switching of inductive loads, and enable the equipment to pass the tests on immunity to electromagnetic interferences defined by the EN 61000-4-2 (Electrostatic discharge), EN 61000-4-4 (Fast Transient/Burst) and EN 61000-4-5 (Surge Test) Standards.

Varistors have an intervention time [20-25 ns] much longer than the intervention time of suppressor diodes (<1 ns) and a higher intervention voltage, but compared to these withstand higher discharge currents. The high discharge current makes them suitable for use in the presence of strong transients, with currents of up to 4500 A impulse 8/20 s. The range of models available makes it possible to choose between nominal voltages suitable for protecting both signals and power supplies with standard voltages of 24 V DC, 48 V DC, or for power supply voltages of 120 V AC and 230 V AC.

APPROVALS

ACCESSORIES

Accessories		DSV120GR	DSV230GR
End section	Grey	DAS/PT/GR (cod. DS101GR)	DAS/PT/GR (cod. DS101GR)
	Beige	DAS/PT (cod. DS101)	DAS/PT (cod. DS101)
	Thickness [mm]	1.5	1.5
Cross connection	[1]	PM/.../... (cod. PM...)	PM/.../... (cod. PM...)
Switchable cross connection		POS/43 (cod. POS43)	POS/43 (cod. POS43)
Multiple common bar	250 mm	PMP/58 (cod. PMP58)	PMP/58 (cod. PMP58)
Shunting screw and sleeve		CPM/01 (cod. CPM01)	CPM/01 (cod. CPM01)
Coloured partition	red	DFU/7/R (cod. DU07R)	DFU/7/R (cod. DU07R)
Test plug socket		PSD/A (cod. PD001)	PSD/A (cod. PD001)
Test plug		SDD/1 (cod. DD001)	SDD/1 (cod. DD001)
Numbering strip		-	-
Cover for cross-connections		PRP/5 (cod. PRP05)	PRP/5 (cod. PRP05)
Marking tag		CNU/8/51 (cod. NU0851S)	CNU/8/51 (cod. NU0851S)
		CNU/10/61 (cod. NU1061S)	CNU/10/61 (cod. NU1061S)
		BTU (cod. BT005)	BTU (cod. BT005)
End bracket	Snap-fit TH35	BT0 (cod. BT007)	BT0 (cod. BT007)
	Screw TH35	BT/3 (cod. BT003)	BT/3 (cod. BT003)
	Screw G32	BT/DIN/PO (cod. BT001)	BT/DIN/PO (cod. BT001)

The **DAS.4V...** connected as in **diagram 2** is an effective protection against differential mode interferences for industrial PLC, DCS, PC inputs and outputs, signal conditioners and sensors, and also for power supplies of electronic equipment in general.

The **DAS.4V...** does not have a signal wiring direction to be observed, as also the connection of the positive and negative polarities can be made either on the lower or the upper level.



Diagram 1

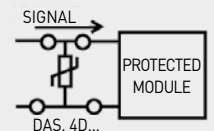

Diagram 2

- two level circuits
- possibility to perform cross-connections on both lower and upper levels (DAS.4/A and DAS.4/B; other versions only lower level)



DEMONSTRATIVE IMAGE



DEMONSTRATIVE IMAGE

(1) See chapter accessories for more details

(2) The voltage and the current ratings given for the various versions are based on the various type of components and to their connections

GREY VERSION	CODE	DS111GR	DS112GR
	TYPE	DAS.4/A/GR	DAS.4/B/GR
BEIGE VERSION	CODE	DS111	DS112
	TYPE	DAS.4/A	DAS.4/B

TECHNICAL CHARACTERISTICS

Function/type		protection against reversal of power supply polarity	protection against reversal of power supply polarity
Rated cross-section	(mm ²)	4	4
Connecting capacity	Flexible (mm ²)	0,2 ÷ 6	0,2 ÷ 6
	Rigid (mm ²)	0,2 ÷ 6	0,2 ÷ 6
	Max. flexible with ferrule - ferrule type (mm ²)	4 - WP40/16	4 - WP40/16
Electrical characteristics According to European standard IEC EN 60947-7-1	Max AC/DC Voltage (V)	630 (2)	630 (2)
	Max current with rated cross-section (A)	1	1
Electrical characteristics According to UL	Section (Caliber)	A4	A4
	Max AC/DC Voltage (V)	600	600
	Max current with rated cross-section (A)	20	20
	Section Min - Max (AWG)	20 - 12	20 - 12
	Tightening torque (lb.in)	8.9	8.9
Rated impulse withstand voltage/pollution degree		- / 3	- / 3
Insulation stripping length (mm)		9	9
Tightening torque value (test / max) (Nm)		0,5 / 1,2	0,5 / 1,2
Length (mm)		64	64
Width (mm)		6	6
Height mounted on TH35/7,5 (mm)		62	62
Height mounted on TH35/15 (mm)		70	70
Height mounted on G32 (mm)		66	66
Insulation material temperature index (EN 60216-1) (°C)		130	130
Plastic material		polyamide UL94V-0	polyamide UL94V-0

APPROVALS

ACCESSORIES			
End section	Grey	DAS/PT/GR (cod. DS101GR)	DAS/PT/GR (cod. DS101GR)
	Beige	DAS/PT (cod. DS101)	DAS/PT (cod. DS101)
	Thickness (mm)	1.5	1.5
Cross connection		PM/.../... (cod. PM...)	PM/.../... (cod. PM...)
Switchable cross connection		POS/43 (cod. POS43)	POS/43 (cod. POS43)
Multiple common bar		PMP/58 (cod. PMP58)	PMP/58 (cod. PMP58)
Shunting screw and sleeve		CPM/01 (cod. CPM01)	CPM/01 (cod. CPM01)
Coloured partition	red	DFU/7/R (cod. DU07R)	DFU/7/R (cod. DU07R)
Test plug socket		PSD/A (cod. PD001)	PSD/A (cod. PD001)
Test plug		SDD/1 (cod. DD001)	SDD/1 (cod. DD001)
Numbering strip		-	-
Cover for cross-connections		PRP/5 (cod. PRP05)	PRP/5 (cod. PRP05)
		CNU/8/51 (cod. NU0851S)	CNU/8/51 (cod. NU0851S)
		CNU/10/61 (cod. NU1061S)	CNU/10/61 (cod. NU1061S)
Marking tag		BTU (cod. BT005)	BTU (cod. BT005)
		BTO (cod. BT007)	BTO (cod. BT007)
		BT/3 (cod. BT003)	BT/3 (cod. BT003)
		BT/DIN/PO (cod. BT001)	BT/DIN/PO (cod. BT001)
End bracket	Snap-fit TH35 and G32	BTU (cod. BT005)	BTU (cod. BT005)
	Snap-fit TH35	BTO (cod. BT007)	BTO (cod. BT007)
	Screw TH35	BT/3 (cod. BT003)	BT/3 (cod. BT003)
	Screw G32	BT/DIN/PO (cod. BT001)	BT/DIN/PO (cod. BT001)



SCREW CLAMP

- two level circuits
- possibility to perform cross-connections on both lower and upper levels (DAS.4/A and DAS.4/B; other versions only lower level)



(1) See chapter accessories for more details

(2) The voltage and the current ratings given for the various versions are based on the various type of components and to their connections

GREY VERSION	CODE	DS113GR	DS114GR
	TYPE	DAS.4/C/GR	DAS.4/D/GR
BEIGE VERSION	CODE	DS113	DS114
	TYPE	DAS.4/C	DAS.4/D

TECHNICAL CHARACTERISTICS

Function/type		block of extra current generated by solenoids as coils, relays, valves, supplied in DC.	block of extra current generated by solenoids as coils, relays, valves, supplied in DC.
Rated cross-section	(mm ²)	4	4
Connecting capacity	Flexible (mm ²)	0,2 ÷ 6	0,2 ÷ 6
	Rigid (mm ²)	0,2 ÷ 6	0,2 ÷ 6
	Max. flexible with ferrule - ferrule type (mm ²)	4 - WP40/16	4 - WP40/16
Electrical characteristics According to European standard IEC EN 60947-7-1	Max AC/DC Voltage (V)	630 [2]	630 [2]
	Max current with rated cross-section (A)	1	1
Electrical characteristics According to UL	Section (Caliber)	A4	A4
	Max AC/DC Voltage (V)	-	-
	Max current with rated cross-section (A)	-	-
	Section Min - Max (AWG)	-	-
	Tightening torque (lb.in)	-	-
Rated impulse withstand voltage/pollution degree		- / 3	- / 3
Insulation stripping length (mm)		9	9
Tightening torque value (test / max) (Nm)		0,5 / 1,2	0,5 / 1,2
Length (mm)		64	64
Width (mm)		6	6
Height mounted on TH35/7,5 (mm)		62	62
Height mounted on TH35/15 (mm)		70	70
Height mounted on G32 (mm)		66	66
Insulation material temperature index (EN 60216-1) (°C)		130	130
Plastic material		polyamide UL94V-0	polyamide UL94V-0

APPROVALS

ACCESSORIES			
End section	Grey	DAS/PT/GR (cod. DS101GR)	DAS/PT/GR (cod. DS101GR)
	Beige	DAS/PT (cod. DS101)	DAS/PT (cod. DS101)
	Thickness (mm)	1.5	1.5
Cross connection		PM/.../... (cod. PM...)	PM/.../... (cod. PM...)
Switchable cross connection		POS/43 (cod. POS43)	POS/43 (cod. POS43)
Multiple common bar		PMP/58 (cod. PMP58)	PMP/58 (cod. PMP58)
Shunting screw and sleeve		CPM/01 (cod. CPM01)	CPM/01 (cod. CPM01)
Coloured partition	red	DFU/7/R (cod. DU07R)	DFU/7/R (cod. DU07R)
Test plug socket		PSD/A (cod. PD001)	PSD/A (cod. PD001)
Test plug		SDD/1 (cod. DD001)	SDD/1 (cod. DD001)
Numbering strip		-	-
Cover for cross-connections		PRP/5 (cod. PRP05)	PRP/5 (cod. PRP05)
Marking tag		CNU/8/51 (cod. NU0851S)	CNU/8/51 (cod. NU0851S)
		CNU/10/61 (cod. NU1061S)	CNU/10/61 (cod. NU1061S)
End bracket	Snap-fit TH35 and G32	BTU (cod. BT005)	BTU (cod. BT005)
	Snap-fit TH35	BTO (cod. BT007)	BTO (cod. BT007)
	Screw TH35	BT/3 (cod. BT003)	BT/3 (cod. BT003)
	Screw G32	BT/DIN/PO (cod. BT001)	BT/DIN/PO (cod. BT001)

- two level circuits
- possibility to perform cross-connections on both lower and upper levels (DAS.4/A and DAS.4/B; other versions only lower level)



DEMONSTRATIVE IMAGE



DEMONSTRATIVE IMAGE

(1) See chapter accessories for more details
(2) The voltage and the current ratings given for the various versions are based on the various type of components and to their connections

GREY VERSION	CODE	DS115GR	DS119GR
	TYPE	DAS.4/E/GR	DAS.4/I/GR
BEIGE VERSION	CODE	DS115	DS119
	TYPE	DAS.4/E	DAS.4/I

TECHNICAL CHARACTERISTICS

Function/type		For LAMP/LED test circuits	For LAMP/LED test circuits
Rated cross-section	(mm ²)	4	4
Connecting capacity	Flexible (mm ²)	0,2 ÷ 6	0,2 ÷ 6
	Rigid (mm ²)	0,2 ÷ 6	0,2 ÷ 6
	Max. flexible with ferrule - ferrule type (mm ²)	4 - WP40/16	4 - WP40/16
Electrical characteristics According to European standard IEC EN 60947-7-1	Max AC/DC Voltage (V)	20÷30	630 [2]
	Max current with rated cross-section (A)	1	1
	Section Caliber	A4	A4
Electrical characteristics According to UL	Max AC/DC Voltage (V)	-	-
	Max current with rated cross-section (A)	-	-
	Section Min - Max (AWG)	-	-
	Tightening torque (lb.in)	-	-
Rated impulse withstand voltage/pollution degree		- / 3	- / 3
Insulation stripping length (mm)		9	9
Tightening torque value (test / max)	(Nm)	0,5 / 1,2	0,5 / 1,2
Length (mm)		64	64
Width (mm)		6	6
Height mounted on TH35/7,5 (mm)		62	62
Height mounted on TH35/15 (mm)		70	70
Height mounted on G32 (mm)		66	66
Insulation material temperature index (EN 60216-1) (°C)		130	130
Plastic material		polyamide UL94V-0	polyamide UL94V-0

APPROVALS

ACCESSORIES			
End section	Grey	DAS/PT/GR (cod. DS101GR)	DAS/PT/GR (cod. DS101GR)
	Beige	DAS/PT (cod. DS101)	DAS/PT (cod. DS101)
	Thickness (mm)	1.5	1.5
Cross connection		PM/.../... (cod. PM...)	PM/.../... (cod. PM...)
Switchable cross connection		POS/43 (cod. POS43)	POS/43 (cod. POS43)
Multiple common bar		PMP/58 (cod. PMP58)	PMP/58 (cod. PMP58)
Shunting screw and sleeve		CPM/01 (cod. CPM01)	CPM/01 (cod. CPM01)
Coloured partition	red	DFU/7/R (cod. DU07R)	DFU/7/R (cod. DU07R)
Test plug socket		PSD/A (cod. PD001)	PSD/A (cod. PD001)
Test plug		SDD/1 (cod. DD001)	SDD/1 (cod. DD001)
Numbering strip		-	-
Cover for cross-connections		PRP/5 (cod. PRP05)	PRP/5 (cod. PRP05)
Marking tag		CNU/8/51 (cod. NU0851S)	CNU/8/51 (cod. NU0851S)
		CNU/10/61 (cod. NU1061S)	CNU/10/61 (cod. NU1061S)
		BTU (cod. BT005)	BTU (cod. BT005)
End bracket	Snap-fit TH35 and G32	BTU (cod. BT005)	BTU (cod. BT005)
	Snap-fit TH35	BTO (cod. BT007)	BTO (cod. BT007)
	Screw TH35	BT/3 (cod. BT003)	BT/3 (cod. BT003)
	Screw G32	BT/DIN/PO (cod. BT001)	BT/DIN/PO (cod. BT001)

SCREW CLAMP

- two level circuits
- possibility to perform cross-connections on both lower and upper levels (DAS.4/A and DAS.4/B; other versions only lower level)



DEMONSTRATIVE IMAGE



DEMONSTRATIVE IMAGE

(1) See chapter accessories for more details

(2) The voltage and the current ratings given for the various versions are based on the various type of components and to their connections

GREY VERSION	CODE	DS130GR	DS120GR
	TYPE	DAS.4/L/GR	DAS.4/DD/GR
BEIGE VERSION	CODE	DS130	DS120
	TYPE	DAS.4/L	DAS.4/DD

TECHNICAL CHARACTERISTICS

Function/type		For LAMP/LED test circuits	For LAMP/LED test circuits
Rated cross-section	(mm ²)	4	4
Connecting capacity	Flexible (mm ²)	0,2 ÷ 6	0,2 ÷ 6
	Rigid (mm ²)	0,2 ÷ 6	0,2 ÷ 6
	Max. flexible with ferrule - ferrule type (mm ²)	4 - WP40/16	4 - WP40/16
Electrical characteristics According to European standard IEC EN 60947-7-1	Max AC/DC Voltage (V)	630 [2]	630 [2]
	Max current with rated cross-section (A)	1	1
	Section Caliber	A4	A4
Electrical characteristics According to UL	Max AC/DC Voltage (V)	-	-
	Max current with rated cross-section (A)	-	-
	Section Min - Max (AWG)	-	-
	Tightening torque (lb.in)	-	-
Rated impulse withstand voltage/pollution degree		- / 3	- / 3
Insulation stripping length (mm)		9	9
Tightening torque value (test / max)	(Nm)	0,5 / 1,2	0,5 / 1,2
Length (mm)		64	64
Width (mm)		6	6
Height mounted on TH35/7,5 (mm)		62	62
Height mounted on TH35/15 (mm)		70	70
Height mounted on G32 (mm)		66	66
Insulation material temperature index (EN 60216-1) (°C)		130	130
Plastic material		polyamide UL94V-0	polyamide UL94V-0

APPROVALS

ACCESSORIES			
End section	Grey	DAS/PT/GR (cod. DS101GR)	DAS/PT/GR (cod. DS101GR)
	Beige	DAS/PT (cod. DS101)	DAS/PT (cod. DS101)
	Thickness (mm)	1.5	1.5
Cross connection		PM/.../... (cod. PM...)	PM/.../... (cod. PM...)
Switchable cross connection		POS/43 (cod. POS43)	POS/43 (cod. POS43)
Multiple common bar		PMP/58 (cod. PMP58)	PMP/58 (cod. PMP58)
Shunting screw and sleeve		CPM/01 (cod. CPM01)	CPM/01 (cod. CPM01)
Coloured partition	red	DFU/7/R (cod. DU07R)	DFU/7/R (cod. DU07R)
Test plug socket		PSD/A (cod. PD001)	PSD/A (cod. PD001)
Test plug		SDD/1 (cod. DD001)	SDD/1 (cod. DD001)
Numbering strip		-	-
Cover for cross-connections		PRP/5 (cod. PRP05)	PRP/5 (cod. PRP05)
Marking tag		CNU/8/51 (cod. NU0851S)	CNU/8/51 (cod. NU0851S)
		CNU/10/61 (cod. NU1061S)	CNU/10/61 (cod. NU1061S)
		BTU (cod. BT005)	BTU (cod. BT005)
End bracket	Snap-fit TH35 and G32	BTU (cod. BT005)	BTU (cod. BT005)
	Snap-fit TH35	BTO (cod. BT007)	BTO (cod. BT007)
	Screw TH35	BT/3 (cod. BT003)	BT/3 (cod. BT003)
	Screw G32	BT/DIN/PO (cod. BT001)	BT/DIN/PO (cod. BT001)

- two level circuits
- possibility to perform cross-connections on both lower and upper levels (DAS.4/A and DAS.4/B; other versions only lower level)



DEMONSTRATIVE IMAGE



DEMONSTRATIVE IMAGE

(1) See chapter accessories for more details

(2) The voltage and the current ratings given for the various versions are based on the various type of components and to their connections

GREY VERSION	CODE	DS128GR	DS129GR
	TYPE	DAS.4/T/GR	DAS.4/U/GR
BEIGE VERSION	CODE	DS128	DS129
	TYPE	DAS.4/T	DAS.4/U

TECHNICAL CHARACTERISTICS

Function/type		voltage indicator	voltage indicator
Rated cross-section	(mm ²)	4	4
Connecting capacity	Flexible (mm ²)	0,2 ÷ 6	0,2 ÷ 6
	Rigid (mm ²)	0,2 ÷ 6	0,2 ÷ 6
	Max. flexible with ferrule - ferrule type (mm ²)	4 - WP40/16	4 - WP40/16
Electrical characteristics According to European standard IEC EN 60947-7-1	Max AC/DC Voltage (V)	20÷30	20÷30
	Max current with rated cross-section (A)	1	1
Electrical characteristics According to UL	Section Caliber	A4	A4
	Max AC/DC Voltage (V)	-	-
	Max current with rated cross-section (A)	-	-
	Section Min - Max (AWG)	-	-
	Tightening torque (lb.in)	-	-
Rated impulse withstand voltage/pollution degree		- / 3	- / 3
Insulation stripping length (mm)		9	9
Tightening torque value (test / max)	(Nm)	0,5 / 1,2	0,5 / 1,2
Length (mm)		64	64
Width (mm)		6	6
Height mounted on TH35/7,5 (mm)		62	62
Height mounted on TH35/15 (mm)		70	70
Height mounted on G32 (mm)		66	66
Insulation material temperature index (EN 60216-1) (°C)		130	130
Plastic material		polyamide UL94V-0	polyamide UL94V-0

APPROVALS

ACCESSORIES			
End section	Grey	DAS/PT/GR (cod. DS101GR)	DAS/PT/GR (cod. DS101GR)
	Beige	DAS/PT (cod. DS101)	DAS/PT (cod. DS101)
	Thickness (mm)	1.5	1.5
Cross connection		PM/.../... (cod. PM...)	PM/.../... (cod. PM...)
Switchable cross connection		POS/43 (cod. POS43)	POS/43 (cod. POS43)
Multiple common bar		PMP/58 (cod. PMP58)	PMP/58 (cod. PMP58)
Shunting screw and sleeve		CPM/01 (cod. CPM01)	CPM/01 (cod. CPM01)
Coloured partition	red	DFU/7/R (cod. DU07R)	DFU/7/R (cod. DU07R)
Test plug socket		PSD/A (cod. PD001)	PSD/A (cod. PD001)
Test plug		SDD/1 (cod. DD001)	SDD/1 (cod. DD001)
Numbering strip		-	-
Cover for cross-connections		PRP/5 (cod. PRP05)	PRP/5 (cod. PRP05)
		CNU/8/51 (cod. NU0851S)	CNU/8/51 (cod. NU0851S)
		CNU/10/61 (cod. NU1061S)	CNU/10/61 (cod. NU1061S)
Marking tag		BTU (cod. BT005)	BTU (cod. BT005)
		BTO (cod. BT007)	BTO (cod. BT007)
		BT/3 (cod. BT003)	BT/3 (cod. BT003)
		BT/DIN/PO (cod. BT001)	BT/DIN/PO (cod. BT001)
End bracket	Snap-fit TH35 and G32	BTU (cod. BT005)	BTU (cod. BT005)
	Snap-fit TH35	BTO (cod. BT007)	BTO (cod. BT007)
	Screw TH35	BT/3 (cod. BT003)	BT/3 (cod. BT003)
	Screw G32	BT/DIN/PO (cod. BT001)	BT/DIN/PO (cod. BT001)

- with flat push-on tab connections
- 6.3 x 0.8 mm flat push-on tab connections compliant with the IEC 60760 Standard



(1) See chapter accessories for more details

GREY VERSION		CODE TYPE		
BEIGE VERSION		CODE TYPE	AF500	AF400
			AF0.2/1+1	AF0.2/2+2
TECHNICAL CHARACTERISTICS				
Function/type			feed-through with push-on tab connections - separate levels	feed-through with push-on tab connections
Rated cross-section		(mm ²)	2.5	2.5
	Flexible	(mm ²)	up to 2.5	up to 2.5
	Rigid	(mm ²)	-	-
Connecting capacity	Max. flexible with ferrule - ferrule type	(mm ²)	-	-
	Max AC/DC Voltage	(V)	400	630
Electrical characteristics According to European standard IEC EN 60947-7-1	Max current with rated cross-section	(A)	20	20
	Section	Caliber	-	-
Electrical characteristics According to UL	Max AC/DC Voltage	(V)	300	600
	Max current with rated cross-section	(A)	15	15
	Section Min - Max	(AWG)	-	-
	Tightening torque	(lb.in)	-	-
Rated impulse withstand voltage/pollution degree			4 KV / 3	6 KV / 3
Insulation stripping length		(mm)	-	-
Tightening torque value (test / max)		(Nm)	-	-
Length		(mm)	44	44
Width		(mm)	6.5	6.5
Height mounted on TH35/7,5		(mm)	49	49
Height mounted on TH35/15		(mm)	57	57
Height mounted on G32		(mm)	52	52
Insulation material temperature index (EN 60216-1)		(°C)	130	130
Plastic material			polyamide UL94V-0	polyamide UL94V-0
APPROVALS				
ACCESSORIES				
End section	Grey		-	-
	Beige		AF0/PT (cod. AF201)	AF0/PT (cod. AF201)
	Blue		-	-
	Thickness	(mm)	1.5	1.5
Cross connection	PTC version (1)		-	-
	PTP version (1)		-	-
	Rated current	(A)	-	-
Cross-connection identification strip		green	-	-
Multiple common bar			-	-
Shunting screw and sleeve			-	-
Coloured partition	red		DFU/1/R (cod. DU01R)	DFU/1/R (cod. DU01R)
Perforated barrier	Grey		-	-
	Beige		-	-
Cross connection barrier		red	-	-
Cover for cable lugs			-	-
Flange			-	-
Test plug socket			-	-
Test plug			-	-
Numbering strip			-	-
Marking tag			CNU/8/51 (cod. NU0851S)	CNU/8/51 (cod. NU0851S)
			CNU/10/61 (cod. NU1061S)	CNU/10/61 (cod. NU1061S)
	Snap-fit TH35 and G32		BTU (cod. BT005)	BTU (cod. BT005)
End bracket	Snap-fit TH35		BTO (cod. BT007)	BTO (cod. BT007)
	Screw TH35		BT/3 (cod. BT003)	BT/3 (cod. BT003)
	Screw G32		BT/DIN/PO (cod. BT001)	BT/DIN/PO (cod. BT001)

- with flat push-on tab connections
- 6.3 x 0.8 mm flat push-on tab connections compliant with the IEC 60760 Standard



(1) See chapter accessories for more details

GREY VERSION	CODE TYPE	PF100GR	PDF.2/GR	FD100GR	FDP.2/GR	CV100GR	CVF.4/GR
BEIGE VERSION	CODE TYPE	PF100	PDF.2	FD100	FDP.2	CV100	CVF.4

TECHNICAL CHARACTERISTICS

Function/type		feed-through for push-on tab connections	feed-through for push-on tab connections	feed-through 1 screw and 3-push-on connections
Rated cross-section	(mm ²)	2.5	2.5	4
Connecting capacity	Flexible (mm ²)	up to 2.5	up to 2.5	up to 2.5
	Rigid (mm ²)	-	-	-
	Max. flexible with ferrule - ferrule type (mm ²)	-	-	-
Electrical characteristics According to European standard IEC EN 60947-7-1	Max AC/DC Voltage (V)	630	800	800
	Max current with rated cross-section (A)	20	20	20
	Section (Caliber)	-	-	-
Electrical characteristics According to UL	Max AC/DC Voltage (V)	600	600	-
	Max current with rated cross-section (A)	16	16	20
	Section Min - Max (AWG)	20-10	20-10	20-10
	Tightening torque (lb.in)	-	-	-
Rated impulse withstand voltage/pollution degree		6 KV / 3	8 KV / 3	6 KV / 3
Insulation stripping length (mm)		-	-	11
Tightening torque value (test / max) (Nm)		-	-	0,5 / 1,2
Length (mm)		57	65.5	48.5
Width (mm)		6.5	6.5	6
Height mounted on TH35/7,5 (mm)		50	49	52
Height mounted on TH35/15 (mm)		58	57	60
Height mounted on G32 (mm)		54	53	56
Insulation material temperature index (EN 60216-1) (°C)		130	130	130
Plastic material		polyamide UL94V-0	polyamide UL94V-0	polyamide UL94V-0

APPROVALS



ACCESSORIES				
End section	Grey	PDF/PT/GR (cod. PF101GR)	FDP/PT/GR (cod. FD101GR)	CVF/PT/GR (cod. CV101GR)
	Beige	PDF/PT (cod. PF101)	FDP/PT (cod. FD101)	CVF/PT (cod. CV101)
	Blue	-	-	CVF/PT (Ex) (cod. CV201)
	Thickness (mm)	1.5	1.5	1.5
Cross connection	PTC version (1)	-	PH/2.5-4 (cod. PH100)	PM/.../... (cod. PM...)
	PTP version (1)	-	-	-
	Rated current (A)	-	-	-
Cross-connection identification strip	green	-	-	-
Multiple common bar		-	-	PMP/58 (cod. PMP58)
Shunting screw and sleeve		-	-	CPM/12 (cod. CPM12)
Coloured partition	red	DFU/5/R (cod. DU05R)	DFU/5/R (cod. DU05R)	DFU/3/R (cod. DU03R)
Perforated barrier	Grey	-	-	-
	Beige	-	-	-
Cross connection barrier	red	-	-	-
Cover for cable lugs		-	-	-
Flange		-	-	-
Test plug socket		-	-	PSD/A (cod. PD001)
Test plug		-	-	SDD/1 (cod. DD001)
Numbering strip		-	-	CNU/8/61/S (cod. NU0861S)
Marking tag		CNU/8/51 (cod. NU0851S)	CNU/8/51 (cod. NU0851S)	CNU/8/51 (cod. NU0851S)
		CNU/10/61 (cod. NU1061S)	CNU/10/61 (cod. NU1061S)	CNU/10/61 (cod. NU1061S)
End bracket	Snap-fit TH35 and G32	BTU (cod. BT005)	BTU (cod. BT005)	BTU (cod. BT005)
	Snap-fit TH35	BTO (cod. BT007)	BTO (cod. BT007)	BTO (cod. BT007)
	Screw TH35	BT/3 (cod. BT003)	BT/3 (cod. BT003)	BT/3 (cod. BT003)
	Screw G32	BT/DIN/PO (cod. BT001)	BT/DIN/PO (cod. BT001)	BT/DIN/PO (cod. BT001)

- for female connectors pitch 5.08 mm
- double possible insertion of the "Easy Bridge" multi-polar connection - PTC cross connection



For the isolation figures with cross connections refer to the table on page 131

GREY VERSION	CODE	VP300GR
	TYPE	VPC.2/GR
BLUE VERSION	CODE	VP310
	TYPE	VPC.2 (EX)I

TECHNICAL CHARACTERISTICS

Function/type		1 screw connection and 2 pins or female connectors
Rated cross-section	(mm ²)	1.5
Connecting capacity	Flexible	(mm ²) 0.2-4
	Rigid	(mm ²) 0.2-4
	Max. flexible with ferrule - ferrule type	(mm ²) 2.5-WP25/14
Electrical characteristics According to European standard IEC EN 60947-7-1	Max AC/DC Voltage	(V) 320
	Max current with rated cross-section	(A) 24 - 12
Electrical characteristics According to UL	Section	Caliber A3
	Max AC/DC Voltage	(V) 600
	Max current with rated cross-section	(A) 15
	Section Min - Max	(AWG) 20-14
	Tightening torque	(lb.in) 5.5
Rated impulse withstand voltage/pollution degree		4 KV / 3
Insulation stripping length	(mm)	9
Tightening torque value (test / max)	(Nm)	0,4 / 0,8
Length	(mm)	44
Width	(mm)	5.08
Height mounted on TH35/7,5	(mm)	51
Height mounted on TH35/15	(mm)	59
Height mounted on G32	(mm)	55
Insulation material temperature index (EN 60216-1)	(°C)	130
Plastic material		polyamide UL94V-0

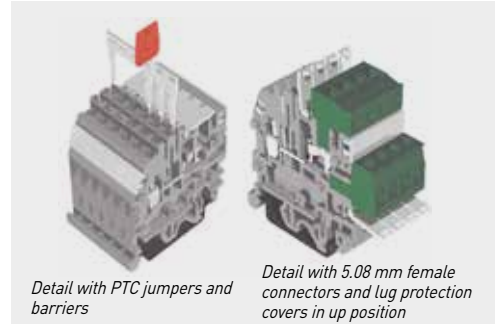

5.08 mm pitch female connectors are available - 90°, with number of poles from 2 up to 16. The connector is easily inserted pressing it up to the stop position, guaranteeing optimal connection on the male contact. In this position the connector is hooked onto the insulating body with the holding tooth with which it is fitted.

APPROVALS



ACCESSORIES

End section	Grey	VPC/PT/GR [cod. VP101GR]
	Beige	VPC/PT [cod. VP101]
	Blue	VPC/PT (Ex)i [cod. VP201]
	Thickness (mm)	3
Cross connection	PTC version (1)	PTC/2/... [cod. PTC02...]
	PTP version (1)	
	Rated current (A)	24
Cross-connection identification strip	green	PTC/SP [cod. PTC0990]
Multiple common bar		-
Shunting screw and sleeve		-
Coloured partition	red	DFU/5/R [cod. DU05R]
Perforated barrier	Grey	DF/VPC/GR [cod. DU02SGR]
	Beige	DF/VPC [cod. DU02S]
Cross connection barrier	red	DFM/300 [cod. DF300]
Cover for cable lugs		VPC/VT [cod. VP102]
Flange		VPC/PTF [cod. VP303]
Test plug socket		-
Test plug		-
Numbering strip		-
Marking tag		CNU/8/51 [cod. NU0851S]
		CNU/10/61 [cod. NU1061S]
End bracket	Snap-fit TH35 and G32	BTU [cod. BT005]
	Snap-fit TH35	BTO [cod. BT007]
	Screw TH35	BT/3 [cod. BT003]
	Screw G32	BT/DIN/PO [cod. BT001]

VPC/F02	2 poles	Cat. No.	VP902
VPC/F03	3 poles	Cat. No.	VP903
VPC/F04	4 poles	Cat. No.	VP904
VPC/F05	5 poles	Cat. No.	VP905
VPC/F06	6 poles	Cat. No.	VP906
VPC/F07	7 poles	Cat. No.	VP907
VPC/F08	8 poles	Cat. No.	VP908
VPC/F09	9 poles	Cat. No.	VP909
VPC/F10	10 poles	Cat. No.	VP910
VPC/F11	11 poles	Cat. No.	VP911
VPC/F12	12 poles	Cat. No.	VP912
VPC/F13	13 poles	Cat. No.	VP913
VPC/F14	14 poles	Cat. No.	VP914
VPC/F15	15 poles	Cat. No.	VP915
VPC/F16	16 poles	Cat. No.	VP916



VPC/PTF
Flange for the securing of female connectors provided with locking screws onto the terminal board



DF/VPC
reduced pitch end section for the separation of different groups

For even more secure fixing of the connector it is possible to use connectors specifically fitted with locking screws on the side. In this case it is necessary to place a VPC/PTF (code VP303) flange alongside, to the right and left of the block of VPC.2 terminal blocks. If the set thus made up proposes a flange with external connection stalks it is necessary to add a VPC/PT terminal plate, or to eliminate the stalks themselves using a cutter. For reasons of safety the connectors must be handled only in the absence of load. Use of the barrier DF/VPC (code DU02S), for physical and/or visual separation of blocks of terminal blocks, does not affect the possibility of creating parallel cross connections. The terminal block can be supplied also in the version with a warning light (VPC/L024). In this case a collector bar (dimensions 7 x 1 x 250 mm), for the common return of a LED (red - 24V), must be inserted in the specific seat on the side of the insulating body of the group of terminal blocks side-by-side and connected via a power supply terminal block VPC.2 (Ex)i/D (code VP400). The power supply terminal block VPC.2 (Ex)i/D is a variant of the VPC.2(Ex)i terminal block equipped with a diode 1N4007. A transparent cover to protect the male shanks from accidental contacts is supplied as an accessory (VPC/VT code VP102) in a 10-pole stick, easily dividable to obtain the number of poles necessary. It snaps into the special seat provided on the insulating bar; the insertion point works as a fulcrum for the rotation of the protection from the closed position (position which is guaranteed by a stopper) to open (for inserting the connector). It is made of transparent material to ensure a view of both the connection type (closed pos.) and the LED, in open position and with the connector inserted.

- for female connectors pitch 5.08 mm – on 2 levels
- double possible insertion of the “Easy Bridge” multi-polar connection - PTC cross connection



(1) See chapter accessories for more details

GREY VERSION	CODE	VP500GR
	TYPE	VPD.2/GR
BLUE VERSION	CODE	VP560
	TYPE	VPD.2 (EX)I

TECHNICAL CHARACTERISTICS

Function/type		2 level feed-through with 2 screw connections and 2 pins for connectors
Rated cross-section	(mm ²)	1
Connecting capacity	Flexible	(mm ²) 0.2-4
	Rigid	(mm ²) 0.2-4
	Max. flexible with ferrule - ferrule type	(mm ²) 2.5-WP25/14
Electrical characteristics According to European standard IEC EN 60947-7-1	Max AC/DC Voltage	(V) 320
	Max current with rated cross-section	(A) 24 - 12
Electrical characteristics According to UL	Section	Caliber A3
	Max AC/DC Voltage	(V) 300
	Max current with rated cross-section	(A) 15
	Section Min - Max	(AWG) 26-12
	Tightening torque	(lb.in) 3,5
Rated impulse withstand voltage/pollution degree		4 KV / 3
Insulation stripping length	(mm)	9
Tightening torque value (test / max)	(Nm)	0,4 / 0,8
Length	(mm)	74
Width	(mm)	5.08
Height mounted on TH35/7,5	(mm)	64
Height mounted on TH35/15	(mm)	72
Height mounted on G32	(mm)	-
Insulation material temperature index (EN 60216-1)	(°C)	130
Plastic material		polyamide UL94V-0

APPROVALS



ACCESSORIES

End section	Grey	VPD/PT/GR (cod. VP501GR)
	Beige	VPD/PT (cod. VP501)
	Blue	VPD/PT (Ex)I (cod. VP561)
	Thickness (mm)	3
Cross connection	PTC version (1)	PTC/2/... (cod. PTC02...)
	PTP version (1)	
	Rated current (A)	24
Cross-connection identification strip	green	PTC/SP (cod. PTC0990)
Multiple common bar		-
Shunting screw and sleeve		-
Coloured partition	red	DFU/7/R (cod. DU07R)
Perforated barrier	Grey	-
	Beige	-
Cross connection barrier	red	DFM/300 (cod. DF300)
Cover for cable lugs		VPD/VT (cod. VP502)
Flange		-
Test plug socket		-
Test plug		-
Numbering strip		-
Marking tag		CNU/8/51 (cod. NU0851S)
		CNU/10/61 (cod. NU1061S)
End bracket	Snap-fit TH35 and G32	BTU (cod. BT005)
	Snap-fit TH35	BTO (cod. BT007)
	Screw TH35	BT/3 (cod. BT003)
	Screw G32	-

For the isolation figures with cross connections refer to the table on page 131

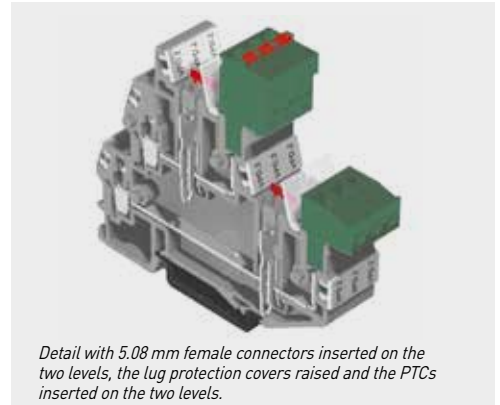

Detail with 5.08 mm female connectors inserted on the two levels, the lug protection covers raised and the PTCs inserted on the two levels.

5.08 mm pitch - 90° female connectors are available, with from 2 up to 16 poles. The connector is easily inserted pressing it up to the stop position, guaranteeing optimal connection on the male contact. In this position the connector is hooked onto the insulating body with the holding tooth, with which it is fitted.

VPC/F02	2 poles	Cat. No.	VP902
VPC/F03	3 poles	Cat. No.	VP903
VPC/F04	4 poles	Cat. No.	VP904
VPC/F05	5 poles	Cat. No.	VP905
VPC/F06	6 poles	Cat. No.	VP906
VPC/F07	7 poles	Cat. No.	VP907
VPC/F08	8 poles	Cat. No.	VP908
VPC/F09	9 poles	Cat. No.	VP909
VPC/F10	10 poles	Cat. No.	VP910
VPC/F11	11 poles	Cat. No.	VP911
VPC/F12	12 poles	Cat. No.	VP912
VPC/F13	13 poles	Cat. No.	VP913
VPC/F14	14 poles	Cat. No.	VP914
VPC/F15	15 poles	Cat. No.	VP915
VPC/F16	16 poles	Cat. No.	VP916

• for thermocouple circuits



CESI 01 ATEX 090 U
I M2 Ex eb I Mb
II 2 G Ex eb IIC Gb

IECEx CES 09.0009U
Ex eb I Mb
Ex eb IIC Gb



BEIGE VERSION	CODE	TC500
	TYPE	TC/PO
GREY VERSION	CODE	TC500GR
	TYPE	TC/PO/GR
BLUE VERSION	CODE	TC510
	TYPE	TC/PO [EX]

TECHNICAL CHARACTERISTICS

Function/type		□ — □	for thermocouple circuits
Rated cross-section		(mm ²)	-
Connecting capacity	Flexible	(mm ²)	-
	Rigid	(mm ²)	∅ 0.8–1.3 mm thermocouples
	Max. flexible with ferrule - ferrule type	(mm ²)	-
Electrical characteristics According to European standard IEC EN 60947-7-1	Max AC/DC Voltage	(V)	800
	Max current with rated cross-section	(A)	-
	Section	Caliber	-
Electrical characteristics According to UL	Max AC/DC Voltage	(V)	600
	Max current with rated cross-section	(A)	15
	Section Min - Max	(AWG)	20 - 14
Electrical characteristics According to ATEX directive and IEC ex standard	Tightening torque	(lb.in)	5.5
	Max AC/DC voltage with G32 rail / TH35 rail	(V)	400 / 630
	Max current with rated cross-section	(A)	<1
Operating temperature	(°C)		-40 +110
Rated impulse withstand voltage/pollution degree			8 KV / 3
Insulation stripping length	(mm)		13
Tightening torque value (test / max)	(Nm)		0,4 / 0,8
Length	(mm)		40.5
Width	(mm)		5.5
Height mounted on TH35/7,5	(mm)		47
Height mounted on TH35/15	(mm)		55
Height mounted on G32	(mm)		51
Insulation material temperature index (EN 60216-1)	(°C)		130
Plastic material			polyamide UL94V-0

APPROVALS



ACCESSORIES		
End section	Grey	CB2/PT (cod. CB111)
	Beige	CB2/PT/GR (cod. CB111GR)
	Blue	CB2/PT (ExI) (cod. CBX13)
	Thickness (mm)	1.5
Coloured partition	red	DFU/1/R (cod. DU01R)
Marking tag		CNU/8/51 (cod. NU0851S)
		CNU/10/61 (cod. NU1061S)
End bracket	Snap-fit TH35 and G32	BTU (cod. BT005)
	Snap-fit TH35	BTO (cod. BT007)
	Screw TH35	BT/3 (cod. BT003)
	Screw G32	BT/DIN/PO (cod. BT001)



Terminal block suitable for connecting any type of conductor for thermocouple circuits. In fact it is possible, thanks to the excellent electrical contact that results from it, to **clamp thermocouples of any type without interposing any compensation material.**

Besides the management of a single article, this solution permits the reduction of the contact points in the overall circuit. The range of diameters of the conductors connectable, to make the connection in question fully effective and permanent, must be between 0.8 and 1.3 mm.

The thermocouple circuits, also of a different diameter, stripped of the insulating sleeve for a length of 20 mm, must be placed one on top of another in the terminal block so as to enable the direct passage of thermoelectric E.M.F. without going through a metal body, as happens in normal circuits.

With the double clamping, ensured by two screws and by the interposition of the pressure plate, the possibility of EMFs determined by the non-uniformity of the contacts is reduced almost to zero.

- AVAILABLE UNTIL STOCKS LAST



(1) See chapter accessories for more details

BEIGE VERSION		CODE TYPE	MA100 MAC.6	MA110 CAM
TECHNICAL CHARACTERISTICS				
Function/type			disconnect lever	shunting element
Rated cross-section		[mm ²]	6	2.5
Connecting capacity	Flexible	[mm ²]	0.5-6	0.5-4
	Rigid	[mm ²]	0.5-10	0.5-6
	Max. flexible with ferrule - ferrule type	[mm ²]	6-WP60/20	4-WP40/16
Electrical characteristics According to European standard IEC EN 60947-7-1	Max AC/DC Voltage	[V]	800	800
	Max current with rated cross-section	[A]	16	24
	Section	Caliber	A5	A3
Electrical characteristics According to UL	Max AC/DC Voltage	[V]	600	600
	Max current with rated cross-section	[A]	16	16
	Section Min - Max	[AWG]	20 - 10	20 - 10
	Tightening torque	[lb.in]	13.3	8.9
Rated impulse withstand voltage/pollution degree			8 KV / 3	8 KV / 3
Insulation stripping length		[mm]	14	12
Tightening torque value (test / max)		[Nm]	1.2 / 1.9	-
Length		[mm]	83	-
Width		[mm]	8	-
Height mounted on TH35/7,5		[mm]	65	-
Height mounted on TH35/15		[mm]	73	-
Height mounted on G32		[mm]	69	-
Insulation material temperature index (EN 60216-1)		[°C]	130	130
Plastic material			polyamide UL94V-0	polyamide UL94V-0

APPROVALS



ACCESSORIES			
Shunting connection		-	MAC/COS (cod. MA030)
Polarization insert		-	MAC/PLZ (cod. MA010)
Safety cover		-	MAC/CP8 (cod. MA040)
Cross connection (1)		PIL/... (cod. PIL...)	-
Test plug		SDD/1 (cod. DD001)	-
Pitching strip		MAC/SPS (cod. MA020)	-
Marking tag		CNU/8/51 (cod. NU0851S)	-
		CNU/10/61 (cod. NU1061S)	-
End bracket	Snap-fit TH35 and G32	BTU (cod. BT005)	-
	Snap-fit TH35	BTO (cod. BT007)	-
	Screw TH35	BT/3 (cod. BT003)	-
	Screw G32	BT/DIN/PO (cod. BT001)	-



CESI 03 ATEX 073 U
I M2 Ex eb I Mb
II 2 G Ex eb IIC Gb

IECEx CES 11.0009U
Ex eb I Mb
Ex eb IIC Gb

(1) See chapter accessories for more details



GREY VERSION	CODE TYPE	RN300GR	RN.1/GR	RN500GR	RN.2/GR	RP300GR	RP.4/GR
BLUE VERSION	CODE TYPE	RN400	RN.1 (EX)I	RN510	RN.2 (EX)I	RP400	RP.4 (EX)I

TECHNICAL CHARACTERISTICS

Function/type		feed-through	feed-through	feed-through
Rated cross-section	(mm²)	1.5	2.5	4
Connecting capacity	Flexible (mm²)	0.2-2.5	0.2-4	0.2-6
	Rigid (mm²)	0.2-2.5	0.2-4	0.2-6
	Max. flexible with ferrule - ferrule type (mm²)	1.5-WP15/14	2.5-WP25/14	4-WP40/16
Electrical characteristics According to European standard IEC EN 60947-7-1	Max AC/DC Voltage (V)	500	500	630
	Max current with rated cross-section (A)	17.5	24	32
	Section Caliber	A1	A3	A4
Electrical characteristics According to UL	Max AC/DC Voltage (V)	600	600	600
	Max current with rated cross-section (A)	15	20	30
	Section Min - Max (AWG)	26-14	20-12	20-12
	Tightening torque (lb.in)	4.5	3.5	4.4
Electrical characteristics According to ATEX directive and IEC ex standard	Max AC/DC voltage with G32 rail / TH35 rail (V)	-	320	320
	Max current with rated cross-section (A)	-	24	32
Operating temperature (°C)		-	-40 +110	-40 +110
Rated impulse withstand voltage/pollution degree		6 KV / 3	6 KV / 3	6 KV / 3
Insulation stripping length (mm)		8	8	9
Tightening torque value (test / max) (Nm)		0.4 / 0.8	0.4 / 0.8	0.5 / 1.2
Length (mm)		27	27	31
Width (mm)		4.2	5	6
Height mounted on TH15 / 5.5 (mm)		32	32	35
Insulation material temperature index (EN 60216-1) (°C)		130	130	130
Plastic material		polyamide UL94V-0	polyamide UL94V-0	polyamide UL94V-0

APPROVALS

ACCESSORIES

End section	Grey	RFN/PT/GR (cod. RF101GR)	RFN/PT/GR (cod. RF101GR)	RP4/PT/GR (cod. RP301GR)
	Blue	RFN/PT (Ex)i (cod. RF201)	RFN/PT (Ex)i (cod. RF201)	RP4/PT (Ex)i (cod. RP401)
	Thickness (mm)	1.5	1.5	1.5
Cross connection	(1)	PM/11/... (cod. PM11...)	PM/12/... (cod. PM12...)	PM/.../... (cod. PM...)
Multiple common bar	250mm	PMP/16 (cod. PMP16)	PMP/25 (cod. PMP25)	PMP/58 (cod. PMP58)
Shunting screw and sleeve (same, Ex e version)		CPM/16 (cod. CPM16)	CPM/16 (cod. CMP16) - CPX/16 (cod. CPX16)	CPM/01 (cod. CPM01) - CPX/01 (cod. CPX01)
Coloured partition	red	DFP/2/R (cod. DFP2R)	DFP/2/R (cod. DFP2R)	DFP/2/R (cod. DFP2R)
Test plug socket		PSD/K (cod. PD011)	PSD/A (cod. PD001)	PSD/A (cod. PD001)
Test plug		SDD/1 (cod. DD001)	SDD/1 (cod. DD001)	SDD/1 (cod. DD001)
Numbering strip		SNZ/4 (cod. SN008)	CNU/8/51 (cod. NU0851S)	CNU/8/61 (cod. NU0861S)
Warning plate		TQM/02 (cod. TQM02)	-	-
Cover for cross-connection		PRP/5 (cod. PRP05)	PRP/5 (cod. PRP05)	PRP/5 (cod. PRP05)
Marking tag		Please Contact Cabur	CNU/8/51 (cod. NU0851S)	CNU/8/51 (cod. NU0851S)
End bracket	Screw TH15	BT/2 (cod. BT006)	BT/2 (cod. BT006)	BT/2 (cod. BT006)



CESI 03 ATEX 022 U
I M2 Ex eb I Mb
II 2 G Ex eb IIC Gb

IECEx CES 11.0004U
Ex eb I Mb
Ex eb IIC Gb



(1) See chapter accessories for more details

YELLOW/GREEN VERSION		CODE	TR110	TR.2	TR200	TR.4
		TYPE				
TECHNICAL CHARACTERISTICS						
Function/type			earth		earth	
Rated cross-section			[mm ²]	2,5	4	
Connecting capacity	Flexible	[mm ²]	0,2-4		0,2-6	
	Rigid	[mm ²]	0,2-4		0,2-6	
	Max. flexible with ferrule - ferrule type	[mm ²]	2,5-WP25/14		4-WP40/16	
Electrical characteristics According to European standard IEC EN 60947-7-2	Max AC/DC Voltage	[V]	-		-	
	Max current with rated cross-section	[A]	-		-	
	Section	Caliber	A3		A4	
Electrical characteristics According to UL	Max AC/DC Voltage	[V]	-		-	
	Max current with rated cross-section	[A]	-		-	
	Section Min - Max	[AWG]	20-12		20-10	
	Tightening torque	[lb.in]	3,5		5,5	
Electrical characteristics According to ATEX directive and IEC ex standard	Max AC/DC voltage with G32 rail / TH35 rail	[V]	-		-	
	Max current with rated cross-section	[A]	24		32	
	Operating temperature	[°C]	-40 +110		-40 +110	
Rated impulse withstand voltage/pollution degree			6 kV / 3		6 kV / 3	
Insulation stripping length			[mm]	8	9	
Tightening torque value (test / max)			[Nm]	0,4 / 0,8	0,5 / 1,2	
Length			[mm]	32	35	
Width			[mm]	5	7,3	
Height mounted on TH15 / 5.5			[mm]	32	35	
Insulation material temperature index (EN 60216-1)			[°C]	130	130	
Plastic material			polyamide UL94V-0		polyamide UL94V-0	
APPROVALS						
ACCESSORIES						
End section	Grey		TR.2/PT (cod. TR111)		-	
	Blue		-		-	
	Thickness	[mm]	1,5		-	
Cross connection	[1]	-		-		
Multiple common bar	250mm	-		-		
Shunting screw and sleeve (same, Ex e version)			-		-	
Coloured partition	red	DFP/2/R (cod. DFP2R)		DFP/2/R (cod. DFP2R)		
Test plug socket			-		-	
Test plug			-		-	
Numbering strip			CNU/8/51 (cod. NU0851S)		-	
Warning plate			-		-	
Cover for cross-connection			-		-	
Marking tag			CNU/8/51 (cod. NU0851S)		CNU/8/51 (cod. NU0851S)	
			CNU/10/61 (cod. NU1061S)		CNU/10/61 (cod. NU1061S)	
End bracket	Screw TH15	BT/2 (cod. BT006)		BT/2 (cod. BT006)		

SCREW CLAMP

- to be fixed directly on panel, by means of screws



Ex CESI 03 ATEX 164 U
I M2 Ex eb I Mb
II 2 G Ex eb IIC Gb

IECEx CES 11.0008U
Ex eb I Mb
Ex eb IIC Gb

[1] when using BPL.4 and TPL.4 terminal blocks in Ex e classified installations, the use of the insulated fixing screw is required.

BEIGE VERSION		CODE TYPE	BP100	TP100	BP200
			BPL.4	TPL.4	BPL/R
TECHNICAL CHARACTERISTICS					
Function/type			two-pole	three-pole	two-pole reduced pitch
Rated cross-section	(mm ²)	4	4	4	
Connecting capacity	Flexible (mm ²)	0.5-6	0.5-6	0.5-6	
	Rigid (mm ²)	0.5-6	0.5-6	0.5-6	
	Max. flexible with ferrule - ferrule type (mm ²)	4-WP40/16	4-WP40/16	4-WP40/16	
Electrical characteristics According to European standard IEC EN 60947-7-1	Max AC/DC Voltage (V)	500	500	500	
	Max current with rated cross-section (A)	32	32	32	
	Section Caliber	A4	A4	A4	
Electrical characteristics According to UL	Max AC/DC Voltage (V)	300	300	300	
	Max current with rated cross-section (A)	20	20	20	
	Section Min - Max (AWG)	12-18	12-18	12-18	
	Tightening torque (lb.in)	4.4	4.4	4.4	
Electrical characteristics According to ATEX directive and IEC ex standard	Max AC/DC voltage with G32 rail / TH35 rail (V)	320	320	320	
	Max current with rated cross-section (A)	32	32	32	
	Operating temperature (°C)	-40+110	-40+110	-40+110	
Rated impulse withstand voltage/pollution degree		6 KV / 3	6 KV / 3	6 KV / 3	
Insulation stripping length (mm)		9	9	9	
Tightening torque value (test / max)	(Nm)	0.5 / 0.7	0.5 / 0.7	0.5 / 0.7	
Width (mm)		20	30	13	
Length (mm)		24	24	24	
Height (mm)		26	26	26	
Fixing screws [1]		M3 (Ø head 5.6 mm max)	M3 (Ø head 5.6 mm max)	-	
Insulation material temperature index (EN 60216-1)	(°C)	130	130	130	
Plastic material		polyamide UL94V-0	polyamide UL94V-0	polyamide UL94V-0	

APPROVALS



NORMAL COMPOSITIONS		
Number of poles	BPL.4 and TPL.4 configurations	Total length (mm)
2	B	20
3	T	30
4	B+B	40
5	B+T	50
6	T+T	60
7	B+T+B	70
8	T+B+T	80
9	T+T+T	90
10	T+B+B+T	100
12	T+T+T+T	120
14	T+T+B+T+T	140
15	T+T+T+T+T	150
16	T+T+B+B+T+T	160
18	T+T+T+T+T+T	180
20	T+T+B+B+T+T+T	200

The bipolar BPL.4, BPL/R and tripolar TPL.4 terminal boards can be fixed separately or used to lock together terminal boards with an unlimited number of poles without using supporting rails. The special "dovetail" channels, ensuring the maximum compactness of assembly, make sufficient the use of only two screws for fixing, at the end of the terminal board. The BPL.4, BPL/R and TPL.4 terminal boards are made ready for marking with NU0550-type name tags.

(*) NOTE:
when using BPL.4 and TPL.4 terminal blocks in Ex e classified installations, the use of the insulated fixing screw is required.

- /PS versions have one screw connection and one flat plug feed-through shank (2.3x0.8 mm) usable also for welding
- to be fixed directly on panel, by means of screws



BEIGE VERSION	CODE TYPE	BP300	TP200
		BPL.4/PS	TPL.4/PS
TECHNICAL CHARACTERISTICS			
Function/type		version with special connections (two-pole)	version with special connections (three-pole)
Rated cross-section	(mm ²)	4	4
Connecting capacity	Flexible (mm ²)	0.5-6	0.5-6
	Rigid (mm ²)	0.5-6	0.5-6
	Max. flexible with ferrule - ferrule type (mm ²)	4-WP40/16	4-WP40/16
Electrical characteristics According to European standard IEC EN 60947-7-1	Max AC/DC Voltage (V)	500	500
	Max current with rated cross-section (A)	32	32
	Section Caliber	A4	A4
Electrical characteristics According to UL	Max AC/DC Voltage (V)	300	300
	Max current with rated cross-section (A)	20	20
	Section Min - Max (AWG)	12-18	12-18
	Tightening torque (lb.in)	4.4	4.4
Electrical characteristics According to ATEX directive and IEC ex standard	Max AC/DC voltage with G32 rail / TH35 rail (V)	-	-
	Max current with rated cross-section (A)	-	-
	Operating temperature (°C)	-	-
Rated impulse withstand voltage/pollution degree		6 KV / 3	6 KV / 3
Insulation stripping length (mm)		9	9
Tightening torque value (test / max)	(Nm)	0.5 / 0.7	0.5 / 0.7
Width (mm)		20	30
Length (mm)		24	24
Height (mm)		36	36
Fixing screws [1]		M3 (Ø head 5.6 mm max)	M3 (Ø head 5.6 mm max)
Insulation material temperature index (EN 60216-1)	(°C)	130	130
Plastic material		polyamide UL94V-0	polyamide UL94V-0

APPROVALS



SCREW CLAMP

NORMAL COMPOSITIONS		
Number of poles	BPL.4 and TPL.4 configurations	Total length (mm)
6	B+R+B	53
8	B+R+R+B	66
10	B+R+R+R+B	79
12	B+R+R+R+R+B	92
14	B+R+R+R+R+R+B	105
16	B+R+R+R+R+R+R+B	118
18	B+R+R+R+R+R+R+R+B	131
20	B+R+R+R+R+R+R+R+R+B	144

PS versions, equipped with solder connections are also available in the following configurations:

- **BPL.4/PS (Cat. No. BP300) - TPL.4/PS (Cat. No. TP200)**
equipped with screw connections on the opposite side from the solder connections
- **BPL.4/PS/A (Cat. No. BP310) - TPL.4/PS/A (Cat. No. TP210)**
equipped with screw connections on the same side as the solder connections

- with 6.3 x 0.8 mm flat push-on tab connections (2 for each pole)
- singular or overlapped mounting



BEIGE VERSION WITHOUT END PLATE	CODE	CF100	CF200
	TYPE		
		CF.12/1+1	CF.12/2+2
BEIGE VERSION WITH END PLATE	CODE	CF900	
	TYPE	CF.12/CPT	

TECHNICAL CHARACTERISTICS

Function/type		feed- through	feed- through
Rated cross-section	(mm ²)	2.5	2.5
Electrical characteristics According to European standard IEC EN 60947-7-1	Max AC/DC Voltage	(V)	500
	Max current with rated cross-section	(A)	20
Rated impulse withstand voltage/pollution degree		6 KV / 3	6 KV / 3
Length	(mm)	109	109
Width	(mm)	34	34
Height	(mm)	16.5	24
Fixing distance between centers		69.5	69.5
Insulation material temperature index (EN 60216-1)	(°C)	130	130
Plastic material		polyamide UL94V-0	polyamide UL94V-0

APPROVALS

ACCESSORIES			
Upper end section	of beige polyamide	CF/PT	-
Insulating bushing	of beige polyamide	CF/BI	CF/BI
Reduced bushing	made of polyamide	-	CF/BR

The **CF.12/1+1** terminal boards can be mounted singularly or one on top of another. In both cases the single terminal board or the terminal board located at the top of the group must be closed with the CF/PT end platelet (thickness 4 mm). Fixing to the panel beneath can be done using:

- screws of an adequate length (**spacing between holes 69.5 mm**)
- **M4 threaded tension rods**

To ensure the maximum insulation from earth and correct mounting of the stacked terminal boards it is necessary to insert the special bushings CF/BI in the holes on the body of the bases. Bushings between the terminal board and the end platelet are not required because the latter is already opportunely shaped.

The above end platelet bears in relief the numbering from 1 to 12 for easy identification of the poles.

The connection plugs, completely protected from the outside and with opportune barriers between them, are made of a copper-zinc alloy, with a high percentage of copper, galvanic anti-rust and anti-corrosive protection in nickel or, on request, in silver (**CF.12/1+1/AG** Code CFA10).

The **CF.12/2+2** terminal boards can be mounted singularly or one on top of another. Fixing to the panel beneath can be done using:

- screws of an adequate length (**spacing between holes 69.5 mm**)
- **M4 threaded stay bolts**

To ensure the maximum insulation from earth and correct mounting of the stacked terminal boards it is necessary to insert the special bushings CF/BI in the holes on the body of the bases. To enable better clamping of the CF/DD nuts, in the case of use of threaded stay bolts, it is opportune to insert in the holes of the upper terminal board the **reduced bushings CF.BR**.

The **CF.12/2+2** terminal boards bear, on both bases, in relief, the numbering from 1 to 12 for easy identification of the poles.

The connection plugs, completely protected from the outside and with opportune barriers between them, are made of a copper-zinc alloy, with a high percentage of copper, galvanic anti-rust and anti-corrosive protection in nickel or, on request, in silver (CF.12/2+2/AG Code CFA20).

Blank lined area for notes.

Distribution Terminal Boards

- 8-poles, 4 ammetric and 4 voltmetric
- Insulating body: of green polycarbonate, filled with fibreglass.
- Conductor body: components of copper-zinc alloy with high percentage of copper and provided with nickel plating.
- Cover: black polyamide



GREEN VERSION	CODE	MZ300N	MZ300T
	TYPE	MS/8x10/N	MS/8x10/T

TECHNICAL CHARACTERISTICS

Rated cross-section		(mm ²)	6	6
Connecting capacity	Flexible	(mm ²)	0.5-16	0.5-16
Test tightening torque		(Nm)	1.2	1.2
Electrical characteristics	Max AC/DC Voltage	(V)	500	500
According to European standard IEC EN 60947-7-1	Max current with rated cross-section	(A)	41	41
Rated impulse withstand voltage/pollution degree			6 KV / 3	6 KV / 3
Width		(mm)	112	112
Length		(mm)	112	112
Height (with cover/including screws)		(mm)	52 / 65	52 / 65
Space between fixing holes		(mm)	92.5	92.5

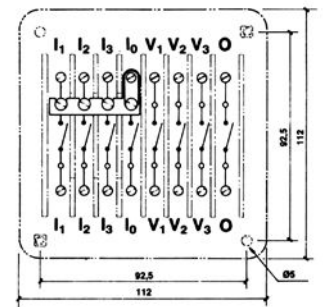
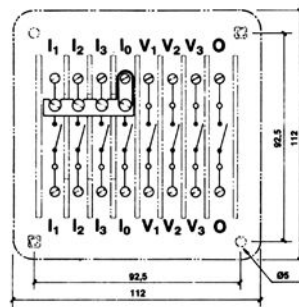

- Available in 7 and 12 hole versions
- Inherent protection against accidental contact IPXXB level according to IEC 60529
- Marking possible with a CNU/8 or CNU/10 tag
- Available in grey, green and blue
- Insulating in polyamide 6.6 UL94V-0



GREY VERSION	CODE TYPE	QBLOK7003 QBLOK.7/GR	QBLOK1203 QBLOK.12/GR
BLUE VERSION	CODE TYPE	QBLOK7001 QBLOK.7/BLU	QBLOK1201 QBLOK.12/BLU
GREEN VERSION	CODE TYPE	QBLOK7002 QBLOK.7/TE	QBLOK1202 QBLOK.12/TE

TECHNICAL CHARACTERISTICS

Function/type		Distribution terminal boards	Distribution terminal boards
Number and diameter of holes		7 holes Ø 5.3 mm	12 holes Ø 5.3 mm
Rated cross-section	(mm²)	10	10
Connecting capacity	Flexible (mm²)	1.5-10	1.5-10
	Rigid (mm²)	1.5-16	1.5-16
	Max.flexible with ferrule - ferrule type (mm²)	10-WP100/21	10-WP100/21
Electrical characteristics According to European standard IEC EN 60947-7-1	Max AC/DC Voltage (V)	500	500
	Max current with rated cross-section (A)	63	63
	Section (Caliber)	B5	B5
Tightening torque value (test / max)	(Nm)	2 / 2.5	2 / 2.5
Rated impulse withstand voltage/pollution degree		-	-
Insulation stripping length	(mm)	6	6
Length	(mm)	53	85
Width	(mm)	16	16
Height mounted on TH35/7,5	(mm)	33	33
Height mounted on TH35/15	(mm)	41	41

APPROVALS



ACCESSORIES			
Marking tag		CNU/8/51 (cod. NU0851S)	CNU/8/51 (cod. NU0851S)
End bracket	Snap fit TH35 and G32	BTU (cod. BT005)	BTU (cod. BT005)
	Screw TH35	BT/3 (cod. BT003)	BT/3 (cod. BT003)
	Snap fit TH35	BTO (cod. BT007)	BTO (cod. BT007)
Mounting rail according to IEC 60715 Std.		PR/3/AC (cod. PR003)	PR/3/AC (cod. PR003)
		PR/3/AS (cod. PR005)	PR/3/AS (cod. PR005)

- Easy installation, with dovetail side supports for better compression
- Visible conductor input thanks to an innovative design with a graduated brass body
- Universal power supply: conductor or bar
- High number of connection points
- IPXXB according to IEC60529
- Captive tightening screw
- HF self-extinguishing plastic sleeve



VERSIONS	CODE TYPE	QBLOK1P160	QBLOK1P250	QBLOK1P400
		QBLOK1P160A6	QBLOK1P250A10	QBLOK1P400A10

TECHNICAL CHARACTERISTICS

Number x section of holes		1 x 70mm ² hole	1 x 120mm ² hole	1 x 185mm ² hole	
		2 x 25mm ² holes	2 x 35mm ² holes	2 x 35mm ² holes	
		3 x 16mm ² holes	3 x 25mm ² holes	3 x 25mm ² holes	
		-	4 x 16mm ² holes	4 x 16mm ² holes	
Rated cross-section	[mm ²]	70	120	185	
Connection capacity of power supply hole 185-120-70 mm ² / bar	Flexible	[mm ²]	10 - 70	35 - 120	95 - 185
	Rigid	[mm ²]	10 - 70	35 - 120	95 - 185
	Max.flexible with ferrule - ferrule type	[mm ²]	50 - WP 350/40	-	-
	Power supply bar - l x S	[mm]	15 x 5	24 x 10	24 x 10
Connection capacity of power supply hole 35 mm ²	Flexible	[mm ²]	-	4 - 35	4 - 35
	Rigid	[mm ²]	-	4 - 35	4 - 35
	Max.flexible with ferrule - ferrule type	[mm ²]	-	25 - WP 250/29	25 - WP 250/29
Connection capacity of power supply hole 25 mm ²	Flexible	[mm ²]	2.5 - 25	2.5 - 25	2.5 - 25
	Rigid	[mm ²]	2.5 - 25	2.5 - 25	2.5 - 25
	Max.flexible with ferrule - ferrule type	[mm ²]	16 - WP 160/22	16 - WP 160/22	16 - WP 160/22
Connection capacity of power supply hole 16 mm ²	Flexible	[mm ²]	1.5 - 16	1.5 - 16	1.5 - 16
	Rigid	[mm ²]	1.5 - 16	1.5 - 16	1.5 - 16
	Max.flexible with ferrule - ferrule type	[mm ²]	10 - WP 100/21	10 - WP 100/21	10 - WP 100/21
Electrical characteristics According to European standard IEC EN 60947-7-1	Max AC/DC Voltage	[V]	1000/1000	1000/1500	1000/1500
	Max current with rated cross-section	[A]	192	269	353
	Section	Caliber	-	-	-
Electrical characteristics According to UL	Max AC/DC Voltage	[V]	600	600	600
	Max current with rated cross-section	[A]	160	250	310
	Section Min-Max	[AWG]	8 - 2/0 (input) / 16 - 4 (output)	2 - 250 Kcmil (input) / 16 - 2 (output)	3/0 - 350 Kcmil (input) / 16 - 2 (output)
Thigtening torque	[lb.in]	88.5 (70mm ²) / 26.6 (16-25mm ²) / 17.7 (bar)	168.2 (120mm ²) / 53.1 (35mm ²) / 26.6 (16-25mm ²) / 17.7 (bar)	221.3 (185mm ²) / 53.1 (35mm ²) / 26.6 (16-25mm ²) / 17.7 (bar)	
Short term current allowed (I _{cw}) (value effective for 1s)	[kA]	-	-	-	
Peak current (ICC)	[kA]	-	-	-	
Rated impulse withstand voltage / pollution degree		8kV / 3	8kV / 3	8kV / 3	
Insulation stripping length	[mm]	17/12/12	27 / 18 / 12	27 / 18 / 12	
Tightening torque	[Nm]	10 for the (70mm ²)	19 for the (120mm ²)	19 for the (185mm ²)	
	[Nm]	2 for the (25 and 16 mm ²)	2.5 for the (35mm ²)	2.5 for the (35mm ²)	
	[Nm]	-	2 for the (25 and 16 mm ²)	2 for the (25 and 16 mm ²)	
Width		74.5	95	95	
Thickness		41	52.7	52.7	
Height on TH/35 7.5 mm		53	80	80	
Height on TH/35 15 mm		61	88	88	
Quantity per pack		1	1	1	

APPROVALS

- Suitable for DIN rail or panel mounting
- High number of connection points
- IPXXB protection degree according to IEC60529
- Compact dimension







[1] for details, see the installation manual

VERSIONS	CODE TYPE	QBLOK1P080E QBLOK1P080A07E	QBLOK1P125E QBLOK1P125A08E	QBLOK1P160E QBLOK1P160A08E
----------	--------------	-------------------------------	-------------------------------	-------------------------------

TECHNICAL CHARACTERISTICS

Number x section of holes	A	1 x 16 mm ²	1 x 35 mm ²	1 x 70 mm ²	
	B	2 x 16 mm ²	1 x 16 mm ²	1 x 16 mm ²	
	C	4 x 6 mm ²	6 x 16 mm ²	6 x 16 mm ²	
	D	-	-	-	
Rated cross-section	(mm ²)	16	35	70	
Connection capacity of input A	Flexible	(mm ²)	6 – 16	10 – 35	10 – 70
	Rigid	(mm ²)	6 – 16	10 – 35	10 – 70
	Max.flexible with ferrule - ferrule type	(mm ²)	10	25	50
	Power supply bar - l x S	(mm)	-	-	-
Connection capacity of output B	Flexible	(mm ²)	2.5 – 16	6 – 16	6 – 16
	Rigid	(mm ²)	2.5 – 16	6 – 16	6 – 16
	Max.flexible with ferrule	(mm ²)	10	10	10
Connection capacity of output C	Flexible	(mm ²)	2.5 – 6	2.5 – 16	2.5 – 16
	Rigid	(mm ²)	2.5 – 6	2.5 – 16	2.5 – 16
	Max.flexible with ferrule	(mm ²)	4	10	10
Connection capacity of output D	Flexible	(mm ²)	-	-	-
	Rigid	(mm ²)	-	-	-
	Max.flexible with ferrule	(mm ²)	-	-	-
Electrical characteristics According to European standard IEC EN 60947-7-1	Max AC/DC Voltage	(V)	1000/1000	1000/1000	1000/1000
	Max current with rated cross-section	(A)	80	125	160
	Section	Caliber	-	-	-
Electrical characteristics According to UL	Max AC/DC Voltage	(V)	600/600	600/600	600/600
	Max current with rated cross-section	(A)	85	150	200
	Section Min-Max	(AWG)	A: 16-4 / B: 16-4 / C: 16-8	A: 8-1/0 / B: 14-2 / C: 14-4	A: 8-3/0 / B: 14-2 / C: 14-4
Thigtening torque	(lb.in)	A: 19.5 / B: 19.5 / C: 10.6	A: 57.0 / B: 31.0 / C: 31.0	A: 75.0 / B: 31.0 / C: 31.0	
Short term current allowed (I _{cw}) (value effective for 1s)	(kA)	3	4.2	11.8	
Peak current (ICC)	(kA)	22	30	30	
Rated impulse withstand voltage / pollution degree		4kV / 3	4kV / 3	4kV / 3	
Insulation stripping lenght	(mm)	A: 17.0 / B: 17.0 / C: 10.2	[1]	[1]	
	(Nm)	A: 3.5	A: 8.5	A: 8.5	
Tightening torque	(Nm)	B: 3.5	B: 3.5	B: 3.5	
	(Nm)	C: 1.2	C: 3.5	C: 3.5	
Width		65	76	76	
Thickness		27.2	29	29	
Height on TH/35 7.5 mm		47.5	47.5	47.5	
Height on TH/35 15 mm		55	55	55	
Quantity per pack		1	1	1	

APPROVALS

- Suitable for DIN rail or panel mounting
- High number of connection points
- IPXXB protection degree according to IEC60529
- Compact dimension







[1] for details, see the installation manual

VERSIONS	CODE TYPE	QBLOK1P250E QBLOK1P250A12E	QBLOK1P400E QBLOK1P400A12E	QBLOK1P500E QBLOK1P500A12E
----------	--------------	-------------------------------	-------------------------------	-------------------------------

TECHNICAL CHARACTERISTICS

Number x section of holes	A	1 x 120 mm ²	1 x 185 mm ²	8x24x1 - 2x20x1 mm (barra)	
	B	2 x 35 mm ²	2 x 35 mm ²	2 x 35 mm ²	
	C	5 x 16 mm ²	5 x 16 mm ²	5 x 16 mm ²	
	D	4 x 10 mm ²	4 x 10 mm ²	4 x 10 mm ²	
Rated cross-section	(mm ²)	120	185	-	
Connection capacity of input A	Flexible	(mm ²)	35 - 120	95 - 185	-
	Rigid	(mm ²)	35 - 120	95 - 185	-
	Max.flexible with ferrule - ferrule type	(mm ²)	95	150	-
	Power supply bar - l x S	(mm)	-	-	8x24x1 - 2x20x1 mm
Connection capacity of output B	Flexible	(mm ²)	6 - 35	6 - 35	6 - 35
	Rigid	(mm ²)	6 - 35	6 - 35	6 - 35
	Max.flexible with ferrule	(mm ²)	25	25	25
Connection capacity of output C	Flexible	(mm ²)	2.5 - 16	2.5 - 16	2.5 - 16
	Rigid	(mm ²)	2.5 - 16	2.5 - 16	2.5 - 16
	Max.flexible with ferrule	(mm ²)	10	10	10
Connection capacity of output D	Flexible	(mm ²)	2.5 - 10	2.5 - 10	2.5 - 10
	Rigid	(mm ²)	2.5 - 10	2.5 - 10	2.5 - 10
	Max.flexible with ferrule	(mm ²)	6	6	6
Electrical characteristics According to European standard IEC EN 60947-7-1	Max AC/DC Voltage	(V)	1000/1000	1000/1000	1000/1000
	Max current with rated cross-section	(A)	250	400	500
	Section	Caliber	-	-	-
Electrical characteristics According to UL	Max AC/DC Voltage	(V)	600/600	600/600	600/600
	Max current with rated cross-section	(A)	255	335	335
	Section Min-Max	(AWG)	A: 6-250kcmil / B: 10-1 / C: 14-4 / D: 14-6	A: 3/0-400kcmil / B: 10-1 / C: 14-4 / D: 14-6	A: - / B: 10-1 / C: 14-4 / D: 14-6
Thigtening torque	(lb.in)	A: 168 / B: 39 / C: 24 / D: 24	A: 221 / B: 39 / C: 24 / D: 24	A: 120 / B: 39 / C: 24 / D: 24	
Short term current allowed (I _{cw}) (value effective for 1s)	(kA)	24.5	24.5	24.5	
Peak current (ICC)	(kA)	51	51	51	
Rated impulse withstand voltage / pollution degree		4kV / 3	4kV / 3	4kV / 3	
Insulation stripping lenght	(mm)	{1}	{1}	{1}	
Tightening torque	(Nm)	A: 19	A: 25	A: 13.5	
	(Nm)	B: 4.4	B: 4.4	B: 4.4	
	(Nm)	C, D: 2.7	C, D: 2.7	C, D: 2.7	
Width		96	96	95	
Thickness		47	47	47	
Height on TH/35 7.5 mm		51	51	51	
Height on TH/35 15 mm		58.5	58.5	58.5	
Quantity per pack		1	1	1	

APPROVALS

- bipolar distribution terminal board
- Easy installation
- Insulating screen for each conducting busbar
- Power supply holes intentionally offset to simplify wiring
- Conforming to EN 60947-7-1
- Zinc-plated steel screws with combined single-slot
- Transparent polycarbonate, self-extinguishing



VERSIONS	CODE	QBLOK2100	QBLOK2125	QBLOK2126
	TYPE	QBLOK2P100A7	QBLOK2P125A11	QBLOK2P125A15

TECHNICAL CHARACTERISTICS

Number and diameter of holes		2 x 7.5 mm holes	2 x 9 mm holes	2 x 9 mm holes
		5 x 5.4 mm holes	2 x 7.5 mm holes	2 x 7.5 mm holes
		-	7 x 5.4 mm holes	11 x 5.4 mm holes
Rated cross-section	(mm ²)	25	35	35
Connecting capacity of power supply hole 9 mm	Flexible	(mm ²)	-	10-35
	Rigid	(mm ²)	-	10-35
	Max.flexible with ferrule - ferrule type	(mm)	-	25-WP 250/29
Connecting capacity of power supply hole 7.5 mm	Flexible	(mm ²)	10-25	10-25
	Rigid	(mm ²)	10-25	10-25
	Max.flexible with ferrule - ferrule type	(mm)	16-WP 160/22	16-WP 160/22
Connecting capacity of power supply hole 5.4 mm	Flexible	(mm ²)	2.5 - 6	2.5 - 6
	Rigid	(mm ²)	2.5 - 6	2.5 - 6
	Max.flexible with ferrule - ferrule type	(mm)	4-WP 40/16	4-WP 40/16
Electrical characteristics According to European standard IEC EN 60947-7-1	Max AC/DC Voltage	(V)	1000	1000
	Max current with rated cross-section	(A)	101	125
	Section	Caliber	-	-
Short term current allowed (I _{cw}) (value effective for 1s)	(kA)	6	4.2	4.2
Peak current according to EN 60947-1 (ICC)	(kA)	20	19	19
Rated impulse withstand voltage / pollution degree		8kV / 3	8kV / 3	8kV / 3
Insulation stripping length	(mm)	13	13	13
Tightening torque	(Nm)	2 / 2.5	2 / 2.5	2 / 2.5
Width		49	49	49
Thickness		72	109	137
Height on TH/35 7.5 mm		52	52	52
Height on TH/35 15 mm		59	59	59
Quantity for package		4	2	2

APPROVALS

ACCESSORIES

Marking tag		CNU/8/51 (cod. NU0851S)	CNU/8/51 (cod. NU0851S)	CNU/8/51 (cod. NU0851S)
End bracket	Snap-fit TH35 and G32	BTU (cod. BT005)	BTU (cod. BT005)	BTU (cod. BT005)
	Snap-fit TH35	BTO (cod. BT007)	BTO (cod. BT007)	BTO (cod. BT007)
	Screw TH35	BT/3 (cod. BT003)	BT/3 (cod. BT003)	BT/3 (cod. BT003)

- four-pole distribution terminal boards
- Easy installation
- Insulating screen for each conducting busbar
- Power supply holes intentionally offset to simplify wiring
- Conforming to EN 60947-7-1
- Zinc-plated steel screws with combined single-slot
- Transparent polycarbonate, self-extinguishing



VERSIONS	CODE	QBLOK4100	QBLOK4125	QBLOK4126
	TYPE	QBLOK4P100A7	QBLOK4P125A11	QBLOK4P125A15

TECHNICAL CHARACTERISTICS

Number and diameter of holes		2 x 7.5 mm holes	2 x 9 mm holes	2 x 9 mm holes
		5 x 5.4 mm holes	2 x 7.5 mm holes	2 x 7.5 mm holes
		-	7 x 5.4 mm holes	11 x 5.4 mm holes
Rated cross-section	(mm ²)	25	35	345
Connecting capacity of power supply hole 9 mm	Flexible	(mm ²)	-	10-35
	Rigid	(mm ²)	-	10-35
	Max.flexible with ferrule - ferrule type	(mm)	-	25-WP 250/29
Connecting capacity of power supply hole 7.5 mm	Flexible	(mm ²)	10-25	10-25
	Rigid	(mm ²)	10-25	10-25
	Max.flexible with ferrule - ferrule type	(mm)	16-WP 160/22	16-WP 160/22
Connecting capacity of power supply hole 5.4 mm	Flexible	(mm ²)	2.5 - 6	2.5 - 6
	Rigid	(mm ²)	2.5 - 6	2.5 - 6
	Max.flexible with ferrule - ferrule type	(mm)	4-WP 40/16	4-WP 40/16
Electrical characteristics According to European standard IEC EN 60947-7-1	Max AC/DC Voltage	(V)	500	500
	Max current with rated cross-section	(A)	101	125
	Section	Caliber	-	-
Short term current allowed (I _{cw}) (value effective for 1s)	(kA)	6	4.2	4.2
Peak current according to EN 60947-1 (ICC)	(kA)	20	19	19
Rated impulse withstand voltage / pollution degree		8kV / 3	8kV / 3	8kV / 3
Insulation stripping length	(mm)	13	13	13
Tightening torque	(Nm)	2 / 2.5	2 / 2.5	2 / 2.5
Width		97	97	97
Thickness		72	108	137
Height on TH/35 7.5 mm		52	52	52
Height on TH/35 15 mm		59	59	59
Quantity for package		2	1	1

APPROVALS

ACCESSORIES

Marking tag		CNU/8/51 (cod. NU0851S)	CNU/8/51 (cod. NU0851S)	CNU/8/51 (cod. NU0851S)
End bracket	Snap-fit TH35 and G32	BTU (cod. BT005)	BTU (cod. BT005)	BTU (cod. BT005)
	Snap-fit TH35	BTO (cod. BT007)	BTO (cod. BT007)	BTO (cod. BT007)
	Screw TH35	BT/3 (cod. BT003)	BT/3 (cod. BT003)	BT/3 (cod. BT003)

- four-pole distribution terminal boards
- Easy installation
- Insulating screen for each conducting busbar
- Power supply holes intentionally offset to simplify wiring
- Conforming to EN 60947-7-1
- Zinc-plated steel screws with combined single-slot
- Transparent polycarbonate, self-extinguishing



VERSIONS	CODE	QBLOK4160S	QBLOK4161N
	TYPE	QBLOK4P160A9	QBLOK4P160A14

TECHNICAL CHARACTERISTICS

Number and diameter of holes		1 x 11 mm hole	1 x 11 mm hole
		2 x 8.5 mm holes	4 x 8.5 mm holes
		6 x 6.5 mm holes	9 x 6.5 mm holes
Rated cross-section	(mm ²)	50	50
Connecting capacity of power supply hole 11 mm	Flexible	(mm ²)	10 – 50
	Rigid	(mm ²)	10 – 50
	Max.flexible with ferrule - ferrule type	(mm)	35-WP 350/30
Connecting capacity of power supply hole 8.5 mm	Flexible	(mm ²)	10-35
	Rigid	(mm ²)	10-35
	Max.flexible with ferrule - ferrule type	(mm)	25-WP 250/29
Connecting capacity of power supply hole 6.5 mm	Flexible	(mm ²)	2.5-16
	Rigid	(mm ²)	2.5-16
	Max.flexible with ferrule - ferrule type	(mm)	16-WP 160/22
Electrical characteristics According to European standard IEC EN 60947-7-1	Max AC/DC Voltage	(V)	500
	Max current with rated cross-section	(A)	160
	Section	Caliber	-
Short term current allowed (I _{cw}) (value effective for 1s)	(kA)	6	6
Peak current according to EN 60947-1 (ICC)	(kA)	28	28
Rated impulse withstand voltage / pollution degree		8kV / 3	8kV / 3
Insulation stripping length	(mm)	13	13
Tightening torque	(Nm)	2 / 2.5	2 / 2.5
Width		99	99
Thickness		131	181
Height on TH/35 7.5 mm		54	54
Height on TH/35 15 mm		61	61
Quantity for package		1	1

APPROVALS

ACCESSORIES			
Marking tag		CNU/8/51 (cod. NU0851S)	CNU/8/51 (cod. NU0851S)
End bracket	Snap-fit TH35 and G32	BTU (cod. BT005)	BTU (cod. BT005)
	Snap-fit TH35	BTO (cod. BT007)	BTO (cod. BT007)
	Screw TH35	BT/3 (cod. BT003)	BT/3 (cod. BT003)

- Mounting on mounting rails PR/3 according to IEC 60715, TH/35 type or with screws on walls
- Insulation voltage 500 V (according to IEC 60947-1)
- Conformity with EU Low Voltage Directive (2014/35/UE)



GREY VERSION	CODE TYPE	QPOL1203 POLM.1215
BLUE VERSION	CODE TYPE	QPOL1205 POLM.1215/BLU
GREEN VERSION	CODE TYPE	QPOL1204 POLM.1215/TE

TECHNICAL CHARACTERISTICS

Function/type		phase or neutral expansion inside electrical panels
Number of pole of 1.5 mm ²		12
Number of pole of 2 mm ²		2
Number of pole of 1mm ²		1
Rated current	[A]	80
Materials		polyamide CW 614N Brass

- CONTC Series terminal blocks are mainly used inside of junction boxes and, from a physical point of view, can be seen as simple Kirchhoff's nodes.
- Transparent polycarbonate, self-extinguishing UL94-V0
- High mechanical and shock resistance also at low temperatures (-25 °C)
- Resistance to flames and to ignition according to IEC 695-2-1
- 850 °C in the incandescent wire test
- High dimensional stability
- Excellent resistance to creeping currents
- High dielectric strength
- Excellent resistance to chemical and atmospheric agents
- CW 614N Brass
- Galvanised steel screws or grub screws



VERSIONS	CODE TYPE	CONT206 CONT/2/06	CONT216 CONT/2/16	CONT225 CONT/2/25	CONT235 CONT/2/35
----------	-----------	----------------------	----------------------	----------------------	----------------------

TECHNICAL CHARACTERISTICS

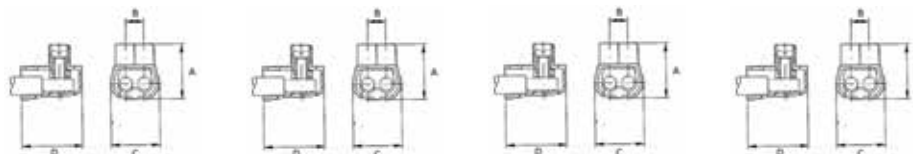

N°poles		2	2	2	2
Rated cross-section	(mm ²)	6	16	25	35
Rated Voltage	(V)	450	500	500	500
Rated current	(A)	41	76	101	125
Insulation material temperature	(°C)	130	130	130	130
Protection degree		IP20	IP20	IP20	IP20
Insulation stripping length	(mm)	6÷13	8÷16	10÷20	12÷23
A	(mm)	16	25	24.5	33
B	(mm)	6	8	10	13
C	(mm)	15	20	25	31.5
D	(mm)	18	22.5	26	31

APPROVALS



VERSIONS	CODE TYPE	CONT306 CONT/3/6	CONT316 CONT/3/16	CONT606 CONT/6/6	CONT616 CONT/6/6	CONT616 CONT/6/6
----------	-----------	---------------------	----------------------	---------------------	---------------------	---------------------

TECHNICAL CHARACTERISTICS

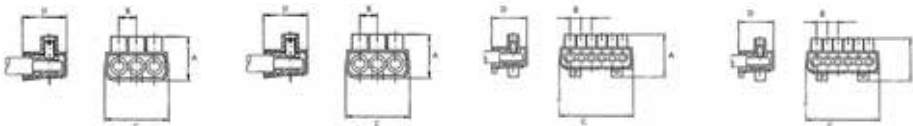

N°poles		3	3	5	1	5	1
Rated cross-section	(mm ²)	6	16	6	10	16	25
Rated Voltage	(V)	450	450	450	450	500	500
Rated current	(A)	41	76	41	41	76	76
Insulation material temperature	(°C)	130	130	130	130	130	130
Protection degree		IP20	IP20	IP20	IP20	IP20	IP20
Insulation stripping length	(mm)	8.5÷11	13÷17	13÷18	13÷18	16÷21	16÷21
A	(mm)	15.25	22	22	22	25	25
B	(mm)	5	9	7	6.5	10	9
C	(mm)	19.5	32.5	46.5	46.5	62	62
D	(mm)	14	22.25	22.5	22.5	25.25	25.25

APPROVALS



- CONTC Series terminal blocks are mainly used inside of junction boxes and, from a physical point of view, can be seen as simple Kirchhoff's nodes
- General characteristics
- High dielectric strength
- Resistance to tracking currents
- Screw-clamp
- Materials
- Products comply with the essential requirements of the BT Directive
- CW 614N Brass
- Zinc-plated screws and dowels
- Transparent polycarbonate



VERSIONS	CODE TYPE	CONTC01 CONT/1,5	CONTC02 CONT/2,5	CONTC04 CONT/4	CONTC06 CONT/6
----------	-----------	---------------------	---------------------	-------------------	-------------------

TECHNICAL CHARACTERISTICS

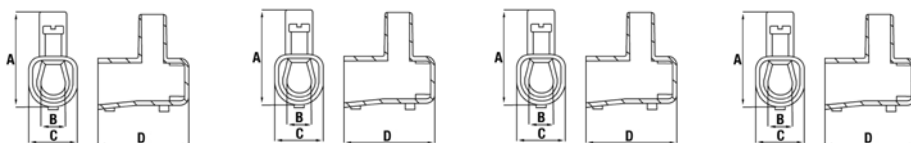

N°poles		10	10	10	10
Rated cross-section	(mm ²)	1.5	2.5	4	6
Rated Voltage	(V)	450	450	450	750
Rated current	(A)	17.5	24	32	41
Insulation material temperature	(°C)	130	130	130	130
Protection degree		IP20	IP20	IP20	IP20
A	(mm)	16	17.6	21	23
B	(mm)	3.3	3.7	4.5	5.6
C	(mm)	8.4	10	10.5	11.5
D	(mm)	15	17.6	21	22.5

APPROVALS



VERSIONS	CODE TYPE	CONTC10 CONT/10	CONTC16 CONT/16	CONTC25 CONT/25	CONTC35 CONT/35
----------	-----------	--------------------	--------------------	--------------------	--------------------

TECHNICAL CHARACTERISTICS

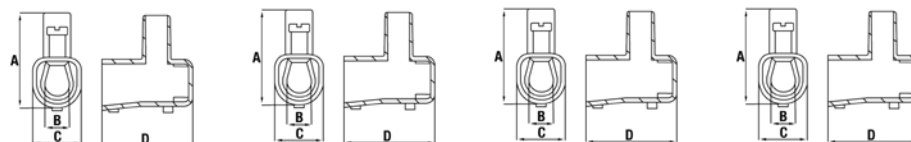

N°poles		10	10	1	1
Rated cross-section	(mm ²)	10	16	25	35
Rated Voltage	(V)	750	750	750	750
Rated current	(A)	57	76	101	125
Insulation material temperature	(°C)	130	130	130	130
Protection degree		IP00	IP00	IP00	IP00
A	(mm)	28	33	39	46
B	(mm)	7.5	9.5	12	14
C	(mm)	14.6	19.7	22	25
D	(mm)	26	31	38	44

APPROVALS



GENERAL CHARACTERISTICS

- Maximum withstand temperature: 80 °C
- Neutral colour

MATERIALS

- Brass
- PA6 Polyamides
- Zinc-plated steel screws



VERSIONS	CODE TYPE	CAMUT02 CAMUT.12/02	CAMUT04 CAMUT.12/04	CAMUT06 CAMUT.12/06	CAMUT010 CAMUT.12/10
----------	--------------	------------------------	------------------------	------------------------	-------------------------

TECHNICAL CHARACTERISTICS

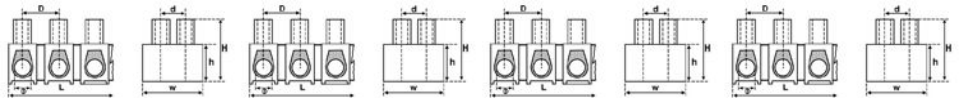

Rated current	[A]	24	32	57	61
Rated Voltage	[V]	380	380	400	400
Cross section	[mm ²]	2,5	4,0	6,0	10,0
Gauge		A3	A3	A4	A5
DIMENSIONS					
L	[mm]	93,0	117,0	132,0	141,0
W	[mm]	17,0	19,0	21,0	23,0
Ø	[mm]	2,8	3,3	4,2	4,5
D	[mm]	8,0	9,8	11,0	11,7
d	[mm]	6,0	6,5	7,8	8,5
H	[mm]	13,7	15,9	16,8	19,0
h	[mm]	8,0	9,0	10,0	10,8

VERSIONS	CODE TYPE	CAMUT16 CAMUT.12/16	CAMUT25 CAMUT.12/25
----------	--------------	------------------------	------------------------

TECHNICAL CHARACTERISTICS

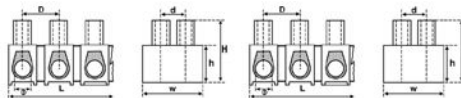

Rated current	[A]	76	101
Rated Voltage	[V]	400	400
Cross section	[mm ²]	16,0	25,0
Gauge		B6	B6
DIMENSIONS			
L	[mm]	168,0	191,0
W	[mm]	26,0	29,7
Ø	[mm]	5,5	6,6
D	[mm]	14,5	16,5
d	[mm]	9,5	11,0
H	[mm]	20,4	25,9
h	[mm]	12,0	15,5

- Maximum insulation voltage: 600V
- Nominal Current: 32A
- Conductor section range (rigid or flexible): 0,2 – 4 mmq
- Protection degree IP20
- With voltage test point



VERSIONS	CODE TYPE	FJ402	FJ403	FJ405
----------	--------------	-------	-------	-------

TECHNICAL CHARACTERISTICS

Rated cross-section	(mm ²)	4	4	4
Connection capacity	(mm ²)	0,2 - 4	0,2 - 4	0,2 - 4
Nominal voltage	(V)	600	600	600
Rated current	(A)	32	32	32
Rated of conductors		2	3	5
Dimensions (L x W x H)	(mm)	12,4 x 20,5 x 14,5	17,0 x 20,5 x 14,5	26,6 x 20,5 x 14,5

THE SPLICING SPRING CONNECTORS

OFFERS MULTIPLE ADVANTAGES:

- Quick installation (without screwdriver)
- Possibility to connect different section cables
- Ergonomics and easy to connect
- Small size
- Secure and reliable cable clamping (spring preloaded in factory)
- Compatible with rigid and flexible cables
- Possibility to connect the cables individually, without the need to strand the conductors

Accessories

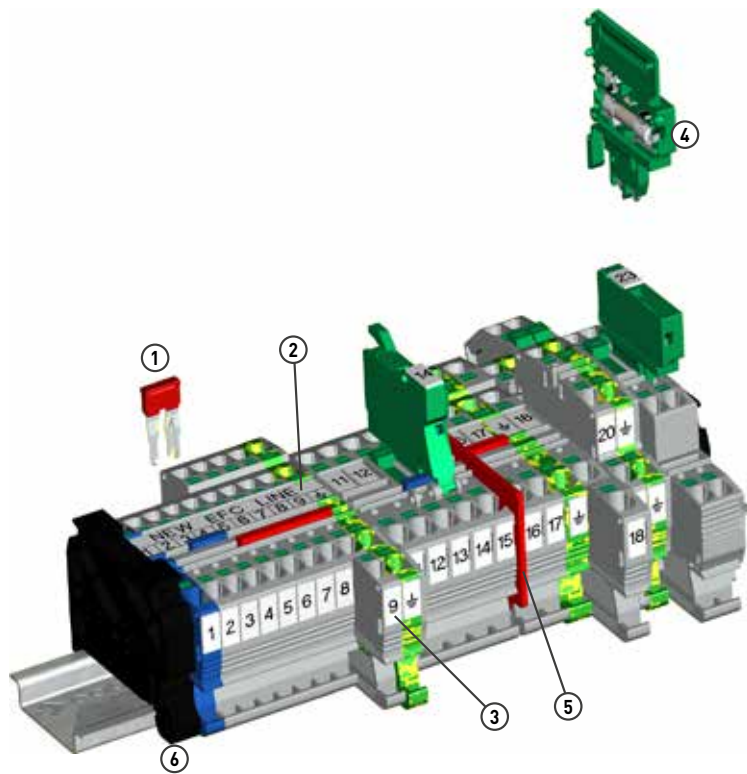

EFC SERIES

- 1 EFB Cross-connection
- 2 Adhesive numbering strip
- 3 Marking tag
- 4 CPFE component holder
- 5 DFE coloured partition
- 6 End bracket

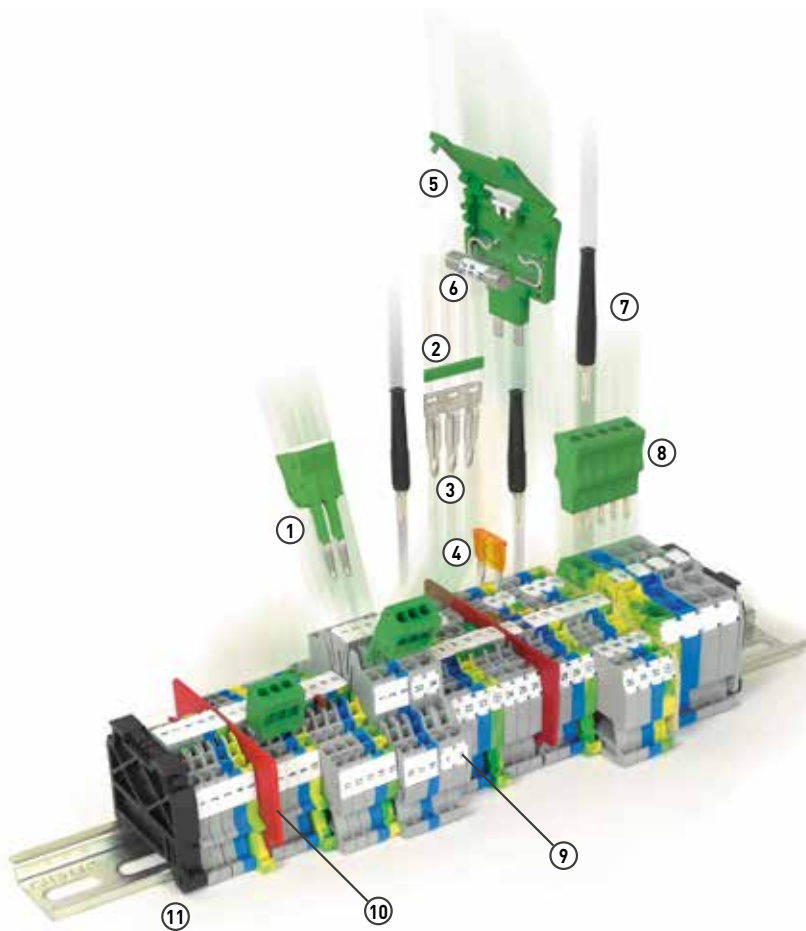

HMM SERIES

- 1 Modular test plug / connector
- 2 Cross-connection identification strip
- 3 PTC Cross-connection
- 4 Blade fuse
- 5 CPF/5 component-holder cartridge (fuse / resistor / diode)
- 6 5 X 20 mm fuse
- 7 Test plug
- 8 Modular Test plug
- 9 Marking tag
- 10 Barrier
- 11 End bracket

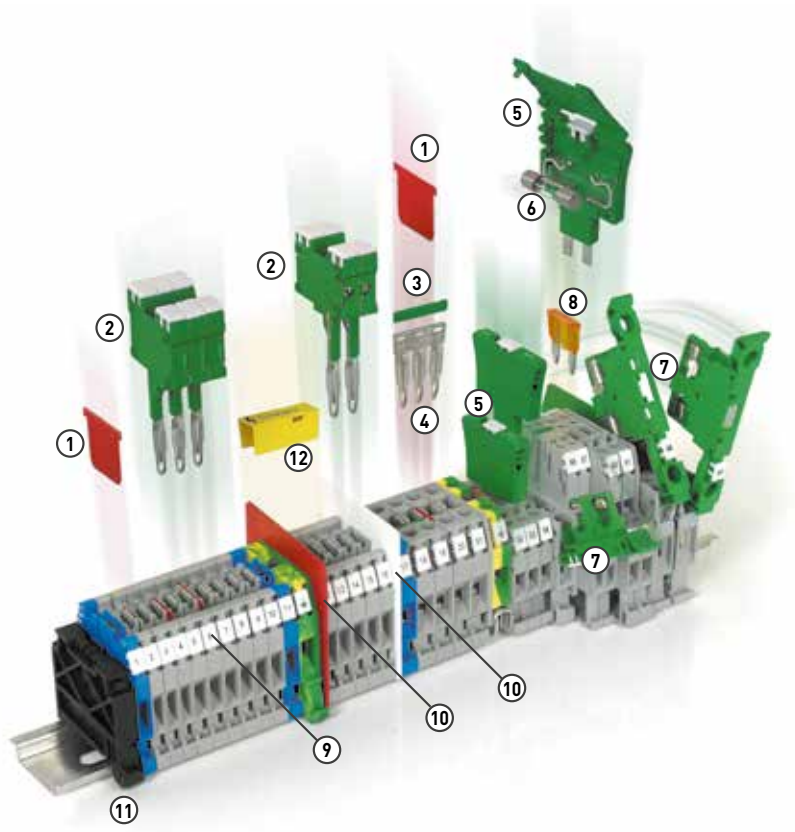

CBC SERIES

- 1 Cross-connection barrier
- 2 Modular test plug
- 3 Cross-connection identification strip
- 4 Easy Bridge cross-connection PTC
- 5 CPF/5 component-holder cartridge (fuse / resistor / diode)
- 6 5 X 20 mm fuse
- 7 Conducting element
- 8 Blade fuse/Test plug
- 9 Marking tag
- 10 Coloured partition
- 11 End bracket
- 12 Warning plate

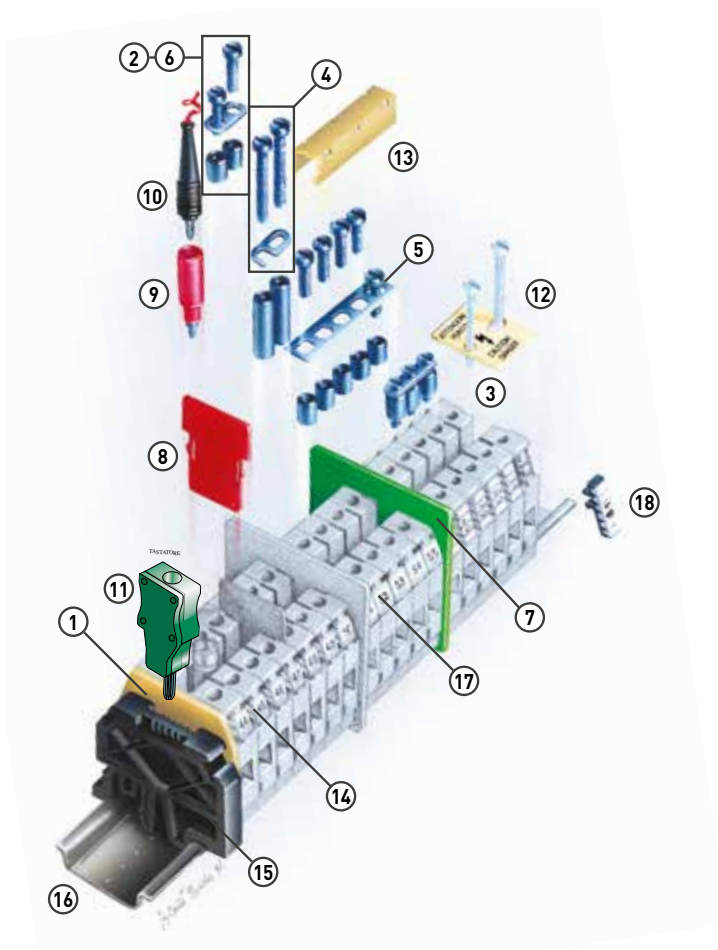

CBD SERIES

- 1 End section
- 2 Permanent cross connection
- 3 Pre-assembled cross connection
- 4 Switchable cross connection
- 5 Multiple cross connection
- 6 Shunting screw and sleeve
- 7 Coloured partition
- 8 Cross connection barrier
- 9 Test plug socket
- 10 Test plug
- 11 Modular test plug
- 12 Warning plate
- 13 Cross connection cover
- 14 Marking tag
- 15 End bracket
- 16 Mounting rail
- 17 Numbering strip
- 18 Tag adapter

For each model and section of terminal block a particular platelet for insulating and closing the open element of each terminal board is provided. This platelet can be used also to separate different phases of terminal blocks connected in parallel or to increase the insulation distances, when required by particular situations.

The end platelets have the size of the related terminal block and thickness of 1.5 mm



TERMINAL BLOCK	END SECTION		TERMINAL BLOCK	END SECTION		TERMINAL BLOCK	END SECTION	
	TYPE	CODE		TYPE	CODE		TYPE	CODE
AFO.2/1+1	AFO/PT	AF201	MPS.4/GR	MPS.4/PT/GR	MP901GR	EFDS.2/1S/GR	EFDS.2/PT/GR	EFDS201GR
AFO.2/2+2	AFO/PT	AF201	MPFA.4	MPS.4/PT	MP901	EFDS.2/P/GR	EFDS.2/PT/GR	EFDS201GR
CBC.2/GR	CBC.2-10/PT/GR	CB061GR	MPFA.4/GR	MPS.4/PT/GR	MP901GR	BLUE POLYAMIDE UL94-V0		
CBC.4/GR	CBC.2-10/PT/GR	CB061GR	MPS.4/SV	MPS.4/PT	MP901	CBC.2[Ex]i	CBC.2-10/PT[Ex]i	CBI061
CBC.6/GR	CBC.2-10/PT/GR	CB061GR	MPS.4/SV/GR	MPS.4/PT/GR	MP901GR	CBC.4[Ex]i	CBC.2-10/PT[Ex]i	CBI061
CBC.10/GR	CBC.2-10/PT/GR	CB061GR	PDF.2	PDF/PT	PF101	CBC.6[Ex]i	CBC.2-10/PT[Ex]i	CBI061
CBC.16/GR	CBC.16/PT/GR	CB161GR	RN.1/GR	RFN/PT/GR	RF101GR	CBC.10[Ex]i	CBC.2-10/PT[Ex]i	CBI061
CBC.35/GR	CBC.35/PT/GR	CB351GR	RN.2/GR	RFN/PT/GR	RF101GR	CBC.16[Ex]i	CBC.16/PT[Ex]i	CBI161
CBD.2	CB2/PT	CB111	RP.4/GR	RP.4/PT/GR	RP301GR	CBC.35[Ex]i	CBC.35/PT[Ex]i	CBI351
CBD.4	CB4/6/PT	CB241	SCB.4	SCB/4/PT	SB301	CBD.2 [Ex]i	CB2/PT[Ex]i	CBX13
CBD.6	CB4/6/PT	CB241	SCB.4/GR	SCB/4/PT/GR	SB301GR	CBD.4[Ex]i	CB4/6/PT [Ex]i	CBX25
CBD.10	CB10/PT	CB431	SCB.6	SCB/6/PT	SB201	CBD.6[Ex]i	CB4/6/PT [Ex]i	CBX25
CBD.16	CB16/PT	CB511	SCB.6/GR	SCB.6/PT/GR	SB201GR	CBD.10[Ex]i	CB10/PT [Ex]i	CBX44
CBD.35	CB35/PT	CB611	SCB.6/DD	SCB/6/PT	SB201	CBD.16[Ex]i	CB16/PT [Ex]i	CBX53
CBD.50	CB50/PT	CB711	SCB.6/DD/GR	SCB/6/PT/GR	SB201GR	CBD.35[Ex]i	CB35/PT [Ex]i	CBX63
CBD.70	CB70/PT	CB811	SCB.10	SCB/10/PT	SB401	CBD.50[Ex]i	CB50/PT [Ex]i	CBX73
CBE.2	CBR/PT	CR111	SCB.10/GR	SCB/10/PT/GR	SB401GR	CBD.70[Ex]i	CB70/PT [Ex]i	CBX83
CBR.2	CBR/PT	CR111	SCB.10/CD	SCB/10/PT	SB401	CVF.4[Ex]i	CVF/PT [Ex]i	CV201
CVF.4	CVF/PT	CV101	SCB.10/CD/GR	SCB/10/PT/GR	SB401GR	DBC.2[Ex]i	DBC/PT[Ex]i	DB201
CVF.4/TP	CVF/PT	CV101	SCB.10/DD	SCB/10/PT	SB401	DAS.4[Ex]i	DAS/PT [Ex]i	DS201
CVF.4/TPM	CVF/PT	CV101	SCB.10/DD/GR	SCB/10/P/GR	SB401GR	DAS.4/Ci[Ex]i	DAS/PT [Ex]i	DS201
CVF.4/VS	CVF/PT	CV101	SCB.6/CD	SCB/6/PT	SB201	HMD.1[Ex]i	HMD.1/PT[Ex]i	HD301
CVF.4/VS2	CVF/PT	CV101	SCB.6/CD/GR	SCB/6/PT/GR	SB201GR	HMD.2N[Ex]i	HMD.1/PT[Ex]i	HD301
CVF.4/WW	CVF/PT	CV101	SFO.4	SFO/PT	SF401	HMM.1[Ex]i	HMT.1/PT [Ex]i	HI401
CVF.4/GR	CVF/PT/GR	CV101GR	SFO.4/GR	SFO/PT/GR	SF401GR	HMM.1/1+2[Ex]	HMT.1/1+2/PT[Ex]i	HI411
CVF.4/TP/GR	CVF/PT/GR	CV101GR	SFO.4/C....	SFO/PT	SF401	HMM.1/2+2[Ex]	HMT.1/2+2/PT[Ex]i	HI421
DBC.2	DBC/PT	DB101	SFR.4	SFR/PT	SF701	HMM.2[Ex]i	HMT.2/PT [Ex]i	HI501
DAS.4	DAS/PT	DS101	SFR.4/C....	SFR/PT	SF701	HMM.2/1+2[Ex]	HMT.2/1+2/PT[Ex]i	HI511
DAS.4/Ci	DAS/PT	DS101	SFR.4/D1A	SFR/PT	SF701	HMM.2/2+2[Ex]	HMT.2/2+2/PT[Ex]i	HI521
DAS.4/SS	DAS/PT	DS101	SFR.4/D3A	SFR/PT	SF701	HMM.4 [Ex]i	HMT.4/PT [Ex]i	HI251
DSF.4/GR	DFS.4/PT/GR	DS401GR	SFR.4/VS	SFR/PT	SF701	HMM.4 [Ex]i	HMT.6/PT [Ex]i	HI321
DSFA.4	DSS/PT	DS301	SFR.6	SFR.6/PT	SR301	MPS.4[Ex]i	MPS.4/PT[Ex]i	MP902
DSFA.4/GR	DSS/PT/GR	DS301GR	TC/PO	TCB/PT	CB111	RN.1 [Ex]i	RFN/PT[Ex]i	RF201
DSS.4	DSS/PT	DS301	TEO.2	TEO.2/PT	TO901	RN2 [Ex]i	RFN/PT[Ex]i	RF201
DSS.4/GR	DSS/PT/GR	DS301GR	TEO.4	TEO.4/PT	TO431	RP.4[Ex]i/PT	RP.4/PT[Ex]i	RP401
FDP.2	FDP/PT	FD101	TED.4	TEO.4/PT	TO431	SFO.4[Ex]i	SFO/PT [Ex]i	SF601
FDP.2/GR	FDP/PT/GR	FD101GR	TDE.2	TLS/PT	TL101	SFR.4[Ex]i	SFR/PT [Ex]i	SF801
FFS.4	FFS/PT	FF101	TDE.2/GR	TLS/PT/GR	TL201GR	SFR.6[Ex]i	SFR.6/PT[Ex]i	SR401
FFS.4/GR	FFS/PT/GR	FF101GR	TLD.2	TLD/PT	TL201	TC/PO[Ex]i	CB2/PT [Ex]i	CBX13
FVS.4	FVS/PT	FV101	TLD.2/GR	TLD/PT/GR	TL201GR	TLD.2[Ex]i	TLD/PT [Ex]i	TL301
FVS.4/GR	FVS/PT/GR	FV101GR	TLS.2	TLS/PT	TL101	VPC.2[Ex]i	VPC/PT [Ex]i	VP201
HCD.1/GR	HCD.1/PT/GR	HC201GR	TLS.2/GR	TLS/PT/GR	TL201GR	VPD.2[Ex]i	VPD/PT[Ex]i	VP561
HDE.2/GR	HLD.2/PT/GR	HL201GR	TLE.2/GR	TLS/PT/GR	TL201GR	EFC.2/BL	EFC.2/PT/BL	EFC201BL
HFR.4/GR	HFR.4/PT/GR	HF211GR	VPC.2	VPC/PT	VP101	EFC.2/1+2/BL	EFC.2/1+2/PT/BL	EFC211BL
HFR.4/M/GR	HFR.4/PT/GR	HF211GR	VPC.2/GR	VPC/PT/GR	VP101GR	EFC.2/2+2/BL	EFC.2/2+2/PT/BL	EFC221BL
HLD.2/GR	HLD.2/PT/GR	HL201GR	VPD.2/GR	VPD/PT/GR	VP501GR	EFCE.2	EFC.2/PT/BL	EFC201BL
HMD.2/GR	HMD/PT/GR	HD101GR	TR.2	TR.2/PT	TR111	EFCE.2/1+2	EFC.2/1+2/PT/BL	EFC211BL
HMF.4/GR	HMF/PT/GR	HF111GR	EFC.2/GR	EFC.2/PT/GR	EFC201GR	EFCE.2/2+2	EFC.2/2+2/PT/BL	EFC221BL
HSCB.4/GR	HSCB.4/PT/GR	HB101GR	EFC.2/1+2/GR	EFC.2/1+2/PT/GR	EFC211GR	EFC.4/BL	EFC.4/PT/BL	EFC401BL
HSCB.6/GR	HSCB.6/PT/GR	HB201GR	EFC.2/2+2/GR	EFC.2/2+2/PT/GR	EFC221GR	EFC.4/1+2/BL	EFC.4/1+2/PT/BL	EFC411BL
HMM.2/GR	HMT.2/PT/GR	HM501GR	EFCE.2	EFC.2/PT/GR	EFC201GR	EFC.4/2+2/BL	EFC.4/2+2/PT/BL	EFC421BL
HMM.2/1+2/GR	HMT.2/1+2/PT/GR	HM511GR	EFCE.2/1+2	EFC.2/1+2/PT/GR	EFC211GR	EFCE.4	EFC.4/PT/BL	EFC401BL
HMM.2/2+2/GR	HMT.2/2+2/PT/GR	HM521GR	EFCE.2/2+2	EFC.2/2+2/PT/GR	EFC221GR	EFCE.4/1+2	EFC.4/1+2/PT/BL	EFC411BL
HMM.2/2+2/S/GR	HMT.2/2+2/PT/GR	HM521GR	EFC.4/GR	EFC.4/PT/GR	EFC401GR	EFCE.4/2+2	EFC.4/2+2/PT/BL	EFC421BL
HMM.4/GR	HMT.4/PT/GR	HM251GR	EFC.4/1+2/GR	EFC.4/1+2/PT/GR	EFC411GR	EFD.2/BL	EFD.2/PT/BL	EFD201BL
HMM.1/GR	HMT.1/PT/GR	HM401GR	EFC.4/2+2/GR	EFC.4/2+2/PT/GR	EFC421GR	EFD.2/Ci/BL	EFD.2/PT/BL	EFD201BL
HMM.1/1+2/GR	HMT.1/1+2/PT	HM411GR	EFCE.4	EFC.4/PT/GR	EFC401GR	EFD.2/E/GR	EFD.2/PT/BL	EFD201BL
HMM.1/2+2/GR	HMT.1/2+2/PT	HM421GR	EFCE.4/1+2	EFC.4/1+2/PT/GR	EFC411GR	EFD.4/BL	EFD.4/PT/BL	EFD401BL
HMD.1/GR	HMD.1/PT/GR	HD201GR	EFCE.4/2+2	EFC.4/2+2/PT/GR	EFC421GR	EFD.4/1+2/BL	EFD.4/PT/BL	EFD401BL
HMD.2N/GR	HMD.1/PT/GR	HD201GR	EFD.2/GR	EFD.2/PT/GR	EFD201GR	EFD.4/E/GR	EFD.4/PT/BL	EFD401BL
HMM.6/GR	HMT.6/PT/GR	HM321GR	EFD.2/Ci/GR	EFD.2/PT/GR	EFD201GR	EFDE.2	EFD.2/PT/BL	EFD201BL
HMS.2/GR	HMT.2/2+2/PT/GR	HM521GR	EFD.2/E/GR	EFD.2/PT/GR	EFD201GR	EFDE.4	EFD.4/PT/BL	EFD401BL
HMFA.2/GR	HMT.2/1+2/PT/GR	HM511GR	EFD.4/GR	EFD.4/PT/GR	EFD401GR	EFF.4/BL	EFC.4/PT/BL	EFC401BL
HP.2/GR	HPV/PT/GR	HV111GR	EFD.4/Ci/GR	EFD.4/PT/GR	EFD401GR	EFF.4/C48/GR	EFC.4/PT/BL	EFC401BL
HPC.2/GR	HPV/PT/GR	HV111GR	EFD.4/E/GR	EFD.4/PT/GR	EFD401GR	EFF.4/C230/GR	EFC.4/PT/BL	EFC401BL
HPP.2/GR	HP/PT/GR	HP101GR	EFDE.2	EFD.2/PT/GR	EFD201GR	EFS.2/BL	EFC.2/PT/BL	EFC201BL
HTE.2	HMT.2/PT	HM501GR	EFDE.4	EFD.4/PT/GR	EFD401GR	EFS.4/BL	EFC.4/PT/BL	EFC401BL
HTE.2/1+2	HMT.2/1+2/PT	HM511GR	EFF.4/GR	EFC.4/PT/GR	EFC401GR	EFT.2/BL	EFT.2/PT/BL	EFT201BL
HTE.2/2+2	HMT.2/2+2/PT	HM521GR	EFF.4/C48/GR	EFC.4/PT/GR	EFC401GR			
HTE.4	HMT.4/PT/GR	HM251GR	EFF.4/C230/GR	EFC.4/PT/GR	EFC401GR			
HTE.6	HMT.6/PT/GR	HM321GR	EFS.2/GR	EFC.2/PT/GR	EFC201GR			
HTE.1	HMT.1/PT/GR	HM401GR	EFS.4/GR	EFC.4/PT/GR	EFC401GR			
HTE.1/1+2	HMT.1/1+2/PT	HM411GR	EFT.2/GR	EFT.2/PT/GR	EFT201GR			
HTE.1/2+2	HMT.1/2+2/PT	HM421GR	EFT.2/GR	EFT.2/PT/GR	EFT201GR			
HTTE.2	HLD.2/PT/GR	HL201GR	EFT.2/S/GR	EFT.2/S/PT/GR	EFT251GR			
MPS.4	MPS.4/PT	MP901	EFDS.2/GR	EFDS.2/PT/GR	EFDS201GR			

ACCESSORIES

TYPE	CODE	DESCRIPTION	MATERIAL	THICKNESS	
BTU	BT005	Universal end bracket, suitable for rails conforming to both IEC 60715, "G32" type and IEC 60715/TH35 (our types PR/DIN and PR/3); it is mounted directly in the desired position and does not require screw fixing.	in black polyamide	8 mm	
BT0	BT007	End bracket suitable for IEC 60715/TH35 rails (our types PR/3); it is mounted directly in the desired position and does not require screw fixing. Particularly suitable if there are rail fixing screws with high heads.	in black polyamide	8 mm	
BT/3	BT003	To be mounted on rails in accordance with the IEC 60715/TH35 standard (our type PR/3)	in black polyamide	8 mm	
BT/2	BT006	To be mounted on rails in accordance with the IEC 60715/TH15 standard (our type PR/2).	in black polyamide	8 mm	

- Universal mounting for both PR/DIN and PR/3 rails which meet IEC 60715 norms, "G32" and TH/35 types
- Made of 6.6 UL94V-0 polyamide - available in grey (RAL 7042)

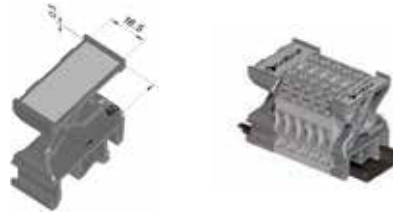

VERSION	CODE TYPE	PTM	PTM
---------	-----------	-----	-----

TECHNICAL CHARACTERISTICS

Width	43
Thickness	19.5
Height on TH/35 7.5 mm	52
Height on TH/35 15 mm	60

ACCESSORIES

Adhesive tags		TA1640AW (cod. TA1640AW)
End bracket	Snap-fit TH35 and G32	BTU (cod. BT005)
	Screw G32	BT/DIN/PO (cod. BT001)
	Screw TH35	BT/3 (cod. BT003)
	Snap-fit TH35	BTO (cod. BT007)

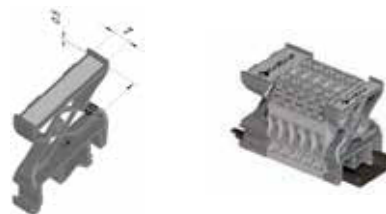
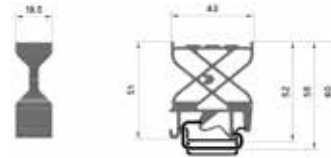

VERSION	CODE TYPE	PTMS	PTMS
---------	-----------	------	------

TECHNICAL CHARACTERISTICS

Width	43
Thickness	9.5
Height on TH/35 7.5 mm	52
Height on TH/35 15 mm	60

ACCESSORIES

Adhesive tags		TA407AW (cod. TA407AW)
End bracket	Snap-fit TH35 and G32	BTU (cod. BT005)
	Screw G32	BT/DIN/PO (cod. BT001)
	Screw TH35	BT/3 (cod. BT003)
	Snap-fit TH35	BTO (cod. BT007)



ACCESSORIES

- Conforming to IEC60715/TH35 - 7.5
- Conforming to IEC60715/TH35 - 15
- Supports for TH/35 rail
- Rail supplied with 2m bars



DESCRIPTION	MATERIAL	TYPE	CODE	DIAGRAMS
Rail conforming to IEC 60715/TH35 - 7.5	in passivated steel	PR/3/AC	PR003	
Rail conforming to IEC 60715/TH35 - 7.5	in white galvanised steel "SENDZMIR" system	PR/3/AC/ZB	PR903	
Rail conforming to IEC 60715/TH35 - 7.5	in passivated steel with slots	PR/3/AS	PR005	
Rail conforming to IEC 60715/TH35 - 7.5	in white galvanised steel "SENDZMIR" system with slots	PR/3/AS/ZB	PR905	<p>SLOT 6.3 x 18 mm pitch 25 mm</p>
Rail conforming to IEC 60715/TH35 - 15	in passivated steel	PR/3/PP	PR007	
Rail conforming to IEC 60715/TH35 - 15	in white galvanised steel "SENDZMIR" system	PR/3/PP/ZB	PR907	
Rail conforming to IEC 60715/TH35 - 15	in passivated steel with slots	PR/3/PA	PR006	
Rail conforming to IEC 60715/TH35 - 15	in white galvanised steel "SENDZMIR" system with slots	PR/3/PA/ZB	PR906	<p>SLOT 6.3 x 18 mm pitch 25 mm</p>
Support for IEC 60715/TH35 rails	in nickel-plated steel with rapid-mounting system 4 MA	ACI121017	Z121017	
Support for IEC 60715/TH35 rails	in nickel-plated steel with rapid-mounting system 5 MA	ACI121019	Z121019	
Rail conforming to IEC 60715, "G32" type	in passivated steel	PR/DIN/AC	PR001	
Rail conforming to IEC 60715, "G32" type	in white galvanised steel "SENDZMIR" system	PR/DIN/AC/ZB	PR901	
Rail conforming to IEC 60715, "G32" type	in passivated steel with slots	PR/DIN/AS	PR004	
Rail conforming to IEC 60715, "G32" type	in white galvanised steel "SENDZMIR" system with slots	PR/DIN/AS/ZB	PR904	<p>SLOT 6.3 x 18 mm pitch 25 mm</p>
Rail conforming to IEC 60715, "G32" type	in aluminium	PR/DIN/AL	PR002	
Rail conforming to IEC 60715/TH15 - 5.5	in passivated steel	PR/2/AC	PR009	
Rail conforming to IEC 60715/TH15 - 5.5	in white galvanised steel "SENDZMIR" system	PR/2/AC/ZB	PR909	
Rail conforming to IEC 60715/TH15 - 5.5	in passivated steel with slots	PR/2/AS	PR010	<p>SLOT 4.2 x 12.2 mm pitch 20 mm</p>
Rail conforming to IEC 60715/TH15 - 5.5	in white galvanised steel "SENDZMIR" system with slots	PR/2/AS/ZB	PR910	

- Inclined bracket
- galvanised busbar holder inclined brackets suitable for fixing terminal block holder rails - M6 thread
- galvanised standard busbar holder flat brackets suitable for fixing terminal block holder rails - M6 thread



DESCRIPTION	TYPE	CODE	DIAGRAMS
Zinc-plated inclined bracket Copper 6 x 6 mm busbar holder for mounting of terminal block holder rails, with the possibility of mounting a (collecting) busbar along the entire length of the terminal block.	ACI121116	Z121116	
Zinc-plated inclined bracket Copper 6 x 6 mm busbar holder for mounting of terminal block holder rails, with the possibility of mounting a (collecting) busbar along the entire length of the terminal block.	ACI121301	Z121301	
Zinc-plated inclined bracket Standard type 2 M5 busbar holder with 2 screw fixing.	ACI121311	Z121311	
Zinc-plated inclined bracket Copper type 2 M6 busbar holder with 2 screw fixing.	ACI121314	Z121314	
Inclined bracket at 30° Standard type 6 M6 busbar holder with 1 screw fixing.	ACI121415	Z121415	
Inclined bracket at 45° Standard type 1 M6 busbar holder with 1 screw fixing.	ACI121228	Z121228	

ACCESSORIES

- Inclined bracket
- galvanised busbar holder inclined brackets suitable for fixing terminal block holder rails - M6 thread
- galvanised standard busbar holder flat brackets suitable for fixing terminal block holder rails - M6 thread



DESCRIPTION	TYPE	CODE	DIAGRAMS
-------------	------	------	----------

Inclined rail holder, standard H = 58 mm	ACI121316	Z121316	
---	-----------	---------	--

Inclined rail holder, standard H = 68 mm	ACI121317	Z121317	
---	-----------	---------	--

Inclined rail holder, standard H = 78 mm	ACI121318	Z121318	
---	-----------	---------	--

Inclined rail holder, standard H = 88 mm	ACI121319	Z121319	
---	-----------	---------	--

Inclined rail holder, standard H = 98 mm	ACI121410	Z121410	
---	-----------	---------	--

ACCESSORIES

- Inclined bracket
- galvanised busbar holder inclined brackets suitable for fixing terminal block holder rails - M6 thread
- galvanised standard busbar holder flat brackets suitable for fixing terminal block holder rails - M6 thread

Fixing distance between centers, with 6MA screw, from 60 to 70 mm

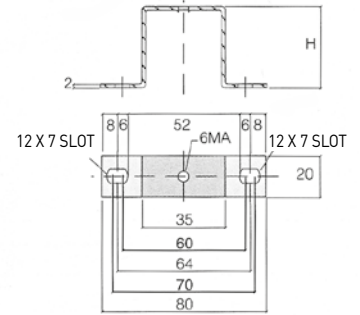

DESCRIPTION	TYPE	CODE	DIAGRAMS
Flat rail support, standard H = 20 mm	ACI121213	Z121213	
Flat rail support, standard H = 25 mm	ACI121214	Z121214	
Flat rail support, standard H = 30 mm	ACI121215	Z121215	
Flat rail support, standard H = 40 mm	ACI121216	Z121216	
Flat rail support, standard H = 50 mm	ACI121217	Z121217	
Flat rail support, standard H = 70 mm	ACI121218	Z121218	
Flat rail support, standard H = 90 mm	ACI121219	Z121219	

ACCESSORIES



DESCRIPTION	TYPE	CODE	DIAGRAMS
6 x 6 mm copper busbar L = 2,000 appropriate for assembly with terminal blocks electrical wire grounding	ACI121123	Z121123	
6 x 6 mm copper busbar blocking terminal with 6 MA x 12 mm screws	ACI121118	Z121118	
Terminal with saddle for 6 x 6 mm copper busbar wire section 0.5-16 mm ²	ACI121119	Z121119	
Terminal with saddle for 6 x 6 mm copper busbar wire section 4-35 mm ²	ACI121121	Z121121	
Special hexagon slot 6 MA x 12 mm screw	ACI121026	Z121026	
Special hexagon slot 5 MA x 10 mm screw	ACI121421	Z121421	
4 MA nut for rapid mounting for 32 x 9 x 15 mm steel bar	ACI121211	Z121211	
5 MA nut for rapid mounting for 32 x 9 x 15 mm steel bar	ACI121212	Z121212	
6 x 6 mm copper busbar blocking terminal with 6 MA x 25 mm screws	ACI121221	Z121221	
Inclined copper busbar support with 6 MA x 10 mm screws and 6 MA nut	ACI121307	Z121307	

- These are supplied pre-assembled for 2-3-5-10 poles
- They allow cross connection of two or more contiguous terminal blocks and are placed in an accident prevention position with respect to the outside
- all the components are made of brass with nickedl-plating surface treatment



TERMINAL BLOCK	2-POLE JUMPER		3-POLE JUMPER		5-POLE JUMPER		10-POLE JUMPER	
	TYPE	CODE	TYPE	CODE	TYPE	CODE	TYPE	CODE
CBD.2	PM/20/2	PM202	PM/20/3	PM203	PM/20/5	PM205	PM/20/10	PM210
CBD.4	PM/40/2	PM402	PM/40/3	PM403	PM/40/5	PM405	PM/40/10	PM400
CBD.6	PM/60/2	PM602	PM/60/3	PM603	PM/60/5	PM605	PM/60/10	PM610
CBD.10	PM/10/2	PM102	PM/10/3	PM103	PM/10/5	PM105	PM/10/10	PM100
CBR.2	PM/25/2	PM252	PM/25/3	PM253	PM/25/5	PM255	PM/25/10	PM250
CVF.4	PM/40/2	PM402	PM/51/3	PM513	PM/51/5	PM515	PM/51/10	PM510
DAS.4	PM/41/2	PM412	PM/51/3	PM513	PM/51/5	PM515	PM/51/10	PM510
RN.1	PM/11/2	PM112	PM/11/3	PM113	PM/11/5	PM115	PM/11/10	PM110
RP.4	PM/41/2	PM412	PM/51/3	PM513	PM/51/5	PM515	PM/51/10	PM510
SCB.4	PM/41/2	PM412	PM/41/3	PM413	PM/41/5	PM415	PM/41/10	PM410
TDE.2	PM/20/2	PM202	PM/30/3	PM303	PM/30/5	PM305	PM/30/10	PM310
TLD.2	PM/20/2	PM202	PM/30/3	PM303	PM/30/5	PM305	PM/30/10	PM310
TLE.2	PM/20/2	PM202	PM/30/3	PM303	PM/30/5	PM305	PM/30/10	PM310
TLS.2	PM/20/2	PM202	PM/30/3	PM303	PM/30/5	PM305	PM/30/10	PM310
RN.2	PM/12/2	PM122	PM/12/3	PM123	PM/12/5	PM125	PM/12/10	PM120
MAC.6	PIL/2	PILO2	PIL/3	PILO3	PIL/4	PILO4	PIL/8	PILO8

- Snap coupling, with no screws
- Possibility of cross and offset-pole connection
- when inserted, intrinsically IPXXB protected installation, without the aid of further insulating protections
- System covered by patent

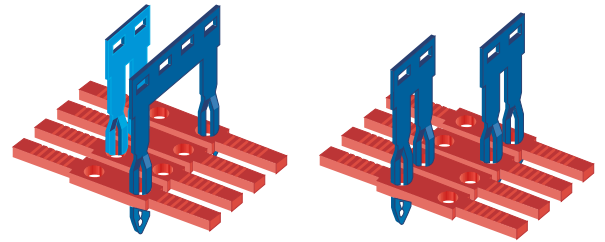

TERMINAL BLOCK	2-POLE JUMPER		3-POLE JUMPER		5-POLE JUMPER		10-POLE JUMPER		JUMPER L = 250 MM		
	TYPE	CODE	TYPE	CODE	TYPE	CODE	TYPE	CODE	TYPE	CODE	POLES
CBC.2	PTC/2/02	PTC0202	PTC/2/03	PTC0203	PTC/2/05	PTC0205	PTC/2/10	PTC0210	PTC/2/00	PTC0200	50
CBC.4	PTC/4/02	PTC0402	PTC/4/03	PTC0403	PTC/4/05	PTC0405	PTC/4/10	PTC0410	PTC/4/00	PTC0400	42
CBC.6	PTC/6/02	PTC0602	PTC/6/03	PTC0603	PTC/6/05	PTC0605	PTC/6/10	PTC0610	PTC/6/00	PTC0600	31
CBC.10	PTC/10/02	PTC1002	PTC/10/03	PTC1003	PTC/10/05	PTC1005	PTC/10/10	PTC1010	PTC/10/00	PTC1000	25
DBC.2	PTC/2/02	PTC0202	PTC/2/03	PTC0203	PTC/2/05	PTC0205	PTC/2/10	PTC0210	PTC/2/00	PTC0200	50
DSFA.4	PTC/4/02	PTC0402	PTC/4/03	PTC0403	PTC/4/05	PTC0405	PTC/4/10	PTC0410	PTC/4/00	PTC0400	42
DSS.4	PTC/4/02	PTC0402	PTC/4/03	PTC0403	PTC/4/05	PTC0405	PTC/4/10	PTC0410	PTC/4/00	PTC0400	42
HMM.1/GR (1)	PTC/1/02	PTC0102	PTC/1/03	PTC0103	PTC/1/05	PTC0105	PTC/1/10	PTC0110	PTC/1/00	PTC0100	50
HMD.1/GR	PTC/1/02	PTC0102	PTC/1/03	PTC0103	PTC/1/05	PTC0105	PTC/1/10	PTC0110	PTC/1/00	PTC0100	50
HCD.1/GR	PTC/2/02	PTC0202	PTC/2/03	PTC0203	PTC/2/05	PTC0205	PTC/2/10	PTC0210	PTC/2/00	PTC0200	50
HDE.2/GR	PTC/3/02	PTC0302	PTC/3/03	PTC0303	PTC/3/05	PTC0305	PTC/3/10	PTC0310	PTC/3/00	PTC0300	47
HLD.2/GR	PTC/3/02	PTC0302	PTC/3/03	PTC0303	PTC/3/05	PTC0305	PTC/3/10	PTC0310	PTC/3/00	PTC0300	47
HFR.4/GR	PTC/5/02	PTC0502	-	-	-	-	-	-	-	-	-
HFR.4/M/GR	PTC/5/02	PTC0502	PTC/5/03	PTC0503	PTC/5/05	PTC0505	PTC/5/10	PTC0510	PTC/5/00	PTC0500	40
HMM.2/GR (1)	PTC/3/02	PTC0302	PTC/3/03	PTC0303	PTC/3/05	PTC0305	PTC/3/10	PTC0310	PTC/3/00	PTC0300	47
HMS.2/GR	PTC/3/02	PTC0302	PTC/3/03	PTC0303	PTC/3/05	PTC0305	PTC/3/10	PTC0310	PTC/3/00	PTC0300	47
HMFA.2/GR	PTC/3/02	PTC0302	PTC/3/03	PTC0303	PTC/3/05	PTC0305	PTC/3/10	PTC0310	PTC/3/00	PTC0300	47
HMM.4/GR (1)	PTC/5/02	PTC0502	PTC/5/03	PTC0503	PTC/5/05	PTC0505	PTC/5/10	PTC0510	PTC/5/00	PTC0500	40
HMFA.2/GR	PTC/3/02	PTC0302	PTC/3/03	PTC0303	PTC/3/05	PTC0305	PTC/3/10	PTC0310	PTC/3/00	PTC0300	47
HSCB.4/GR	PTC/5/02	PTC0502	PTC/5/03	PTC0503	PTC/5/05	PTC0505	PTC/5/10	PTC0510	PTC/5/00	PTC0500	40
HSCB.6/GR	PTC/8/02	PTC0802	PTC/8/03	PTC0803	PTC/8/05	PTC0805	PTC/8/10	PTC0810	PTC/8/00	PTC0800	30
HMM.4/GR	PTC/8/02	PTC0802	PTC/8/03	PTC0803	PTC/8/05	PTC0805	PTC/8/10	PTC0810	PTC/8/00	PTC0800	30
HMM.10/GR	PTC/11/02	PTC1102	PTC/11/03	PTC1103	PTC/11/05	PTC1105	PTC/11/10	PTC1110	PTC/11/00	PTC1100	25
HMM.16/GR	PTC/16/02	PTC1602	PTC/16/03	PTC1603	PTC/16/05	PTC1605	PTC/16/10	PTC1610	PTC/16/00	PTC1600	20
HVPC.2/GR	PTC/3/02	PTC0302	PTC/3/03	PTC0303	PTC/3/05	PTC0305	PTC/3/10	PTC0310	PTC/3/00	PTC0300	47
CHP.2/GR	PTC/3/02	PTC0302	PTC/3/03	PTC0303	PTC/3/05	PTC0305	PTC/3/10	PTC0310	PTC/3/00	PTC0300	47
CHP.2D/GR	PTC/3/02	PTC0302	PTC/3/03	PTC0303	PTC/3/05	PTC0305	PTC/3/10	PTC0310	PTC/3/00	PTC0300	47
HPP.2/GR	PTC/3/02	PTC0302	PTC/3/03	PTC0303	PTC/3/05	PTC0305	PTC/3/10	PTC0310	PTC/3/00	PTC0300	47
HP.2/GR	PTC/3/02	PTC0302	PTC/3/03	PTC0303	PTC/3/05	PTC0305	PTC/3/10	PTC0310	PTC/3/00	PTC0300	47
HPC.2/GR	PTC/3/02	PTC0302	PTC/3/03	PTC0303	PTC/3/05	PTC0305	PTC/3/10	PTC0310	PTC/3/00	PTC0300	47
MPS.4	PTC/4/02	PTC0402	PTC/4/03	PTC0403	PTC/4/05	PTC0405	PTC/4/10	PTC0410	PTC/4/00	PTC0400	42
MPFA.4	PTC/4/02	PTC0402	PTC/4/03	PTC0403	PTC/4/05	PTC0405	PTC/4/10	PTC0410	PTC/4/00	PTC0400	42
SFR.6	PTC/20/02	PTC2002	PTC/20/03	PTC2003	PTC/20/05	PTC2005	PTC/20/10	PTC2010	PTC/20/00	PTC2000	25
VPC.2	PTC/2/02	PTC0202	PTC/2/03	PTC0203	PTC/2/05	PTC0205	PTC/2/10	PTC0210	PTC/2/00	PTC0200	50
VPD.2	PTC/2/02	PTC0202	PTC/2/03	PTC0203	PTC/2/05	PTC0205	PTC/2/10	PTC0210	PTC/2/00	PTC0200	50
CBS.2	PTC/2/02	PTC0202	PTC/2/03	PTC0203	PTC/2/05	PTC0205	PTC/2/10	PTC0210	PTC/2/00	PTC0200	50
CBS.4 - CBF.4	PTC/4/02	PTC0402	PTC/4/03	PTC0403	PTC/4/05	PTC0405	PTC/4/10	PTC0410	PTC/4/00	PTC0400	42



After cutting the bar for the number of poles necessary, insert the cross connection in the special cavity of the terminal block.
At this point working with the tip of a screwdriver, push the cross connection up to the locking point. The cross connection will be completely isolated and intrinsically IPXXB protected.



After inserting the cross connection, the poles connected can be highlighted with the aid of the green insert, PTC/SP. This accessory is supplied in the standard length of 100 mm and can easily be sliced with the aid of a simple cutter.



To remove the cross connection it is sufficient to remove the PTC/SP insert, insert the tip of the screwdriver in the slot of the cross connection itself, lever it and pull it out.

(1) Including the versions /1+2, /2+2 and/or the corresponding earth terminal blocks, if available.

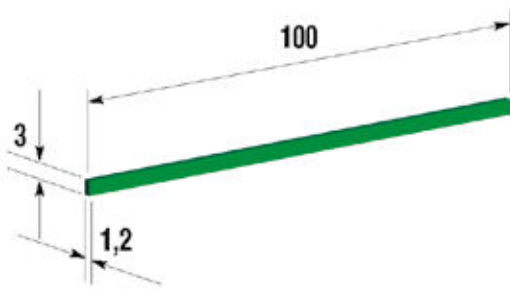

In panels with little light, seeing clearly where the cross connections are inserted is not always immediate and easy if particular attention is not paid; this can cause connection errors.

It is precisely to solve this problem that Cabur has created a marker to be used on its terminal blocks that adopt PTC cross connections, in order to make locating them easier, after insertion.

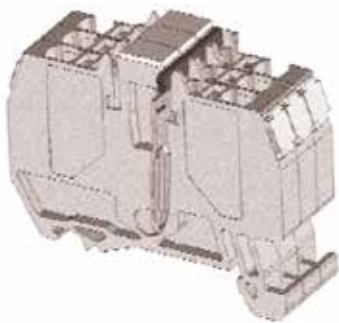

Examples of application on the HMM.2 terminal block.

The dimensions of the marker have been studied so as not to protrude from the profile of any of the terminal blocks on which it can be applied, so as not to interfere with numbering, cables or other accessories.

A single model was created (PTC/SP - Cat. No. PTC0990) common to all terminal blocks, irrespective of the pitch or the model of the PTC cross connection used. The marker must be housed in the cross-connection seat; stability on the terminal block is guaranteed by the friction on the walls of the cross-connection insertion grooves.

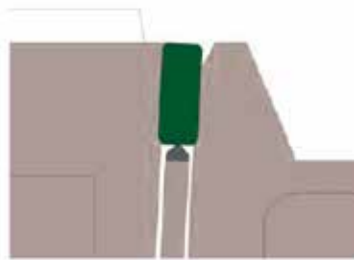

The marker can be applied also in the case of double cross connections. It is to be noted that the marker can be applied in the presence of other accessories, without having to be extracted in advance.

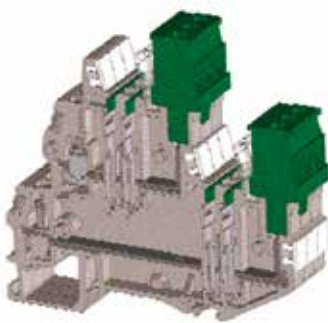

Examples of application on the VPD.2 terminal block.

The marker is produced in sticks of a length of 100 mm each and is supplied in green. Users can autonomously reduce its length according to their needs.

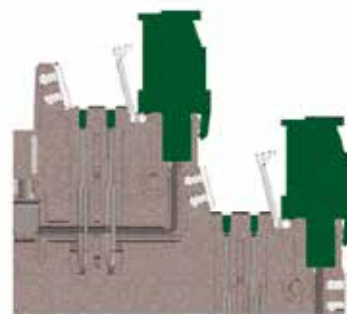

The cutting operation is possible with no difficulty using a common pair of pliers, because the thickness of the sticks, made of polyamide, is only 1.20 mm.

Note:

application of the PTC/SP marker is possible on all terminal blocks that adopt PTC cross connections (as in the list) with the exception of the HCD.1 and HMD.2N terminal blocks: in these two terminal blocks the shape of the cross-connection seat makes it impossible to obtain the friction necessary to guarantee stably the positioning and permanence. In the same way the cross connections of these two terminal blocks have a less deep introduction compared to all the others and therefore the presence of the cross connection can be seen without the need for the marker.

- Snap coupling, with no screws
- Possibility of cross and offset-pole connection
- when inserted, intrinsically IPXXB protected installation, without the aid of further insulating protections
- Colours red or blue for immediate visibility of the cross connection and identification of polarity or phase
- Upper surface markable with indelible marker pen



TERMINAL BLOCK	JUMPER COLOUR	2-POLE JUMPER		3-POLE JUMPER		5-POLE JUMPER		10-POLE JUMPER		30-POLE JUMPER	
		TYPE	CODE	TYPE	CODE	TYPE	CODE	TYPE	CODE	TYPE	CODE
CBC.2/GR	RED	PTP/2/02/R	PTP0202R	PTP/2/03/R	PTP0203R	PTP/2/05/R	PTP0205R	PTP/2/10/R	PTP0210R	PTP/2/30/R	PTP0230R
	BLUE	PTP/2/02/B	PTP0202B	PTP/2/03/B	PTP0203B	PTP/2/05/B	PTP0205B	PTP/2/10/B	PTP0210B	PTP/2/30/B	PTP0230B
CBC.4/GR	RED	PTP/4/02/R	PTP0402R	PTP/4/03/R	PTP0403R	PTP/4/05/R	PTP0405R	PTP/4/10/R	PTP0410R	PTP/4/30/R	PTP0430R
	BLUE	PTP/4/02/B	PTP0402B	PTP/4/03/B	PTP0403B	PTP/4/05/B	PTP0405B	PTP/4/10/B	PTP0410B	PTP/4/30/B	PTP0430B
CBS.2 and CBS.2/GR	RED	PTP/2/02/R	PTP0202R	PTP/2/03/R	PTP0203R	PTP/2/05/R	PTP0205R	PTP/2/10/R	PTP0210R	PTP/2/30/R	PTP0230R
	BLUE	PTP/2/02/B	PTP0202B	PTP/2/03/B	PTP0203B	PTP/2/05/B	PTP0205B	PTP/2/10/B	PTP0210B	PTP/2/30/B	PTP0230B
CBS.4 and CBS.4/GR	RED	PTP/4/02/R	PTP0402R	PTP/4/03/R	PTP0403R	PTP/4/05/R	PTP0405R	PTP/4/10/R	PTP0410R	PTP/4/30/R	PTP0430R
	BLUE	PTP/4/02/B	PTP0402B	PTP/4/03/B	PTP0403B	PTP/4/05/B	PTP0405B	PTP/4/10/B	PTP0410B	PTP/4/30/B	PTP0430B
CBF.4/GR	RED	PTP/4/02/R	PTP0402R	PTP/4/03/R	PTP0403R	PTP/4/05/R	PTP0405R	PTP/4/10/R	PTP0410R	PTP/4/30/R	PTP0430R
	BLUE	PTP/4/02/B	PTP0402B	PTP/4/03/B	PTP0403B	PTP/4/05/B	PTP0405B	PTP/4/10/B	PTP0410B	PTP/4/30/B	PTP0430B
HMM.2/GR (1)	RED	PTP/3/02/R	PTP0302R	PTP/3/03/R	PTP0303R	PTP/3/05/R	PTP0305R	PTP/3/10/R	PTP0310R	PTP/3/30/R	PTP0330R
	BLUE	PTP/3/02/B	PTP0302B	PTP/3/03/B	PTP0303B	PTP/3/05/B	PTP0305B	PTP/3/10/B	PTP0310B	PTP/3/30/B	PTP0330B
HMM.4/GR (1)	RED	PTP/5/02/R	PTP0502R	PTP/5/03/R	PTP0503R	PTP/5/05/R	PTP0505R	PTP/5/10/R	PTP0510R	PTP/5/30/R	PTP0530R
	BLUE	PTP/5/02/B	PTP0502B	PTP/5/03/B	PTP0503B	PTP/5/05/B	PTP0505B	PTP/5/10/B	PTP0510B	PTP/5/30/B	PTP0530B
HMD.2N/GR	RED	PTP/3/02/R	PTP0302R	PTP/3/03/R	PTP0303R	PTP/3/05/R	PTP0305R	PTP/3/10/R	PTP0310R	PTP/3/30/R	PTP0330R
	BLUE	PTP/3/02/B	PTP0302B	PTP/3/03/B	PTP0303B	PTP/3/05/B	PTP0305B	PTP/3/10/B	PTP0310B	PTP/3/30/B	PTP0330B
HLD.2/GR	RED	PTP/3/02/R	PTP0302R	PTP/3/03/R	PTP0303R	PTP/3/05/R	PTP0305R	PTP/3/10/R	PTP0310R	PTP/3/30/R	PTP0330R
	BLUE	PTP/3/02/B	PTP0302B	PTP/3/03/B	PTP0303B	PTP/3/05/B	PTP0305B	PTP/3/10/B	PTP0310B	PTP/3/30/B	PTP0330B
HDE.2/GR	RED	PTP/3/02/R	PTP0302R	PTP/3/03/R	PTP0303R	PTP/3/05/R	PTP0305R	PTP/3/10/R	PTP0310R	PTP/3/30/R	PTP0330R
	BLUE	PTP/3/02/B	PTP0302B	PTP/3/03/B	PTP0303B	PTP/3/05/B	PTP0305B	PTP/3/10/B	PTP0310B	PTP/3/30/B	PTP0330B
CHP.2/GR	RED	PTP/3/02/R	PTP0302R	PTP/3/03/R	PTP0303R	PTP/3/05/R	PTP0305R	PTP/3/10/R	PTP0310R	PTP/3/30/R	PTP0330R
	BLUE	PTP/3/02/B	PTP0302B	PTP/3/03/B	PTP0303B	PTP/3/05/B	PTP0305B	PTP/3/10/B	PTP0310B	PTP/3/30/B	PTP0330B
CHP.2D/GR	RED	PTP/3/02/R	PTP0302R	PTP/3/03/R	PTP0303R	PTP/3/05/R	PTP0305R	PTP/3/10/R	PTP0310R	PTP/3/30/R	PTP0330R
	BLUE	PTP/3/02/B	PTP0302B	PTP/3/03/B	PTP0303B	PTP/3/05/B	PTP0305B	PTP/3/10/B	PTP0310B	PTP/3/30/B	PTP0330B
HVPC.2/GR	RED	PTP/3/02/R	PTP0302R	PTP/3/03/R	PTP0303R	PTP/3/05/R	PTP0305R	PTP/3/10/R	PTP0310R	PTP/3/30/R	PTP0330R
	BLUE	PTP/3/02/B	PTP0302B	PTP/3/03/B	PTP0303B	PTP/3/05/B	PTP0305B	PTP/3/10/B	PTP0310B	PTP/3/30/B	PTP0330B
HMS.2/GR	RED	PTP/3/02/R	PTP0302R	PTP/3/03/R	PTP0303R	PTP/3/05/R	PTP0305R	PTP/3/10/R	PTP0310R	PTP/3/30/R	PTP0330R
	BLUE	PTP/3/02/B	PTP0302B	PTP/3/03/B	PTP0303B	PTP/3/05/B	PTP0305B	PTP/3/10/B	PTP0310B	PTP/3/30/B	PTP0330B
HMFA.2/GR	RED	PTP/3/02/R	PTP0302R	PTP/3/03/R	PTP0303R	PTP/3/05/R	PTP0305R	PTP/3/10/R	PTP0310R	PTP/3/30/R	PTP0330R
	BLUE	PTP/3/02/B	PTP0302B	PTP/3/03/B	PTP0303B	PTP/3/05/B	PTP0305B	PTP/3/10/B	PTP0310B	PTP/3/30/B	PTP0330B
HSCB.4/GR	RED	PTP/3/02/R	PTP0302R	PTP/3/03/R	PTP0303R	PTP/3/05/R	PTP0305R	PTP/3/10/R	PTP0310R	PTP/3/30/R	PTP0330R
	BLUE	PTP/3/02/B	PTP0302B	PTP/3/03/B	PTP0303B	PTP/3/05/B	PTP0305B	PTP/3/10/B	PTP0310B	PTP/3/30/B	PTP0330B
HFR.4/M/GR	RED	PTP/3/02/R	PTP0302R	PTP/3/03/R	PTP0303R	PTP/3/05/R	PTP0305R	PTP/3/10/R	PTP0310R	PTP/3/30/R	PTP0330R
	BLUE	PTP/3/02/B	PTP0302B	PTP/3/03/B	PTP0303B	PTP/3/05/B	PTP0305B	PTP/3/10/B	PTP0310B	PTP/3/30/B	PTP0330B
DBC.2/GR	RED	PTP/2D/02/R	PTP02D02R	PTP/2D/03/R	PTP02D03R	PTP/2D/05/R	PTP02D05R	PTP/2D/10/R	PTP02D10R	PTP/2D/30/R	PTP02D30R
	BLUE	PTP/2D/02/B	PTP02D02B	PTP/2D/03/B	PTP02D03B	PTP/2D/05/B	PTP02D05B	PTP/2D/10/B	PTP02D10B	PTP/2D/30/B	PTP02D30B
DBC.4/GR	RED	PTP/4D/02/R	PTP04D02R	PTP/4D/03/R	PTP04D03R	PTP/4D/05/R	PTP04D05R	PTP/4D/10/R	PTP04D10R	PTP/4D/30/R	PTP04D30R
	BLUE	PTP/4D/02/B	PTP04D02B	PTP/4D/03/B	PTP04D03B	PTP/4D/05/B	PTP04D05B	PTP/4D/10/B	PTP04D10B	PTP/4D/30/B	PTP04D30B

(1) Including the versions /1+2, /2+2 and/or the corresponding earth terminal blocks, if available.



After cutting the bar for the number of poles necessary, insert the cross connection in the special seat in the terminal block. With the tip of the screwdriver push the cross-connection until it comes to a stop. The cross connection will be completely insulated, intrinsically IPXXB protected and visible.



The upper surface can be marked with an indelible marker pen to indicate the presence of the pole and of the electrical connection with the underlying terminal block in cross connections with alternating poles

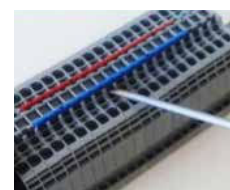

To remove the cross connection it is sufficient to insert the tip of the screwdriver in the slot of the cross connection itself and lever it to pull it out; with cross connections of more than 5 poles lever gradually at the centre and at the two ends until it is completely extracted

To guarantee the correct safety conditions, after insertion and depending on the multiple connection schemes obtainable using the PTC/PTP cross connections, the table below is provided:

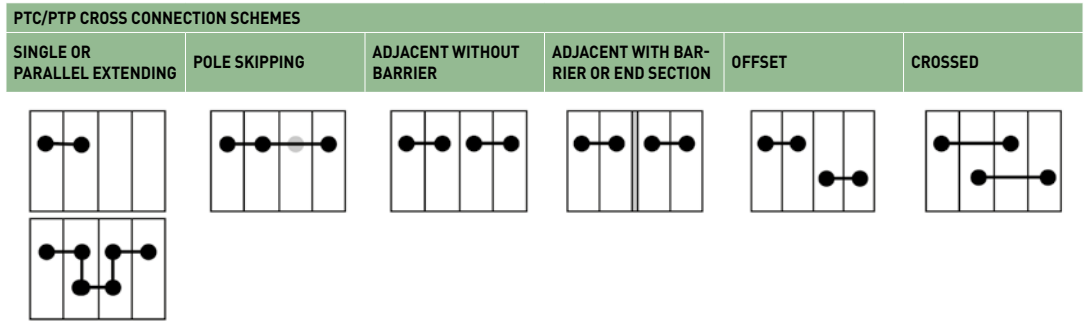

TERMINAL BLOCK	JUMPER TYPE	ISOLATION VOLTAGE IN THE ABOVE CONFIGURATIONS (V)					
		SINGLE OR PARALLEL EXTENDING	POLE SKIPPING	ADJACENT WITHOUT BARRIER	ADJACENT WITH BARRIER OR END SECTION	OFFSET	CROSSED
CBC.2	PTC/2 PTP/2	630	630	-	500	500	500
CBC.4	PTC/4 PTP/4	630	500	-	500	500	500
CBC.6	PTC/6	630	630	-	630	630	500
CBC.10	PTC/10	800	630	-	630	800	500
VPC.2	PTC/2	320	320	-	320	320	320
HMFA.2 - HMS.2	PTC/3	630	500	-	500 (1)	-	-
HMM.1 Series	PTC/1	630	630	-	320	630	630
HMM.2 Series	PTC/3 PTP/3	630	500	-	500 (1)	630	630
HMM.4 Series	PTC/5 PTP/5	500	500	-	500 (1)	500	500
HMM.10	PTC/11	1000	1000	-	800	1000	1000
HMM.16	PTC/16	1000	1000	-	800	1000	800
DBC.2	PTC/2	630	500	-	250 (2)	500	500
DBC.2	PTC/2	630	500	-	630 (3)	500	500
HCD.1	PTC/2	320	320	-	320	320	320
HVPC.2/GR	PTC/3	500	500	-	500 (1)	500	500
CHP.2/GR - CHP.2D/GR	PTC/11	500 (630)	500	-	400 (1)	-	-
HPP.2/GR - HP.2/GR	PTC/3	400	400	-	800 (1)	500	400
HPC.2/GR	PTC/3	400	400	-	800 (1)	400	400
SFR.6	PTC/20	630	630	400	630	630	500
MPS.4-MPFA.4	PTC/4	400	400	-	400	-	-
DSS.4-DSFA.4	PTC/4	400	400	-	400	-	-
HMD.1	PTC/1	500	500	-	320	500	500
VPD.2	PTC/2	320	320	-	320	320	320
HSCB.4	PTC/5	500	500	-	500 (1)	500	500
HSCB.6	PTC/8	500	500	-	400	500	500

(1) with interposition of end platelet

(2) between lower adjacent cross connections (with barrier)

(3) between upper adjacent cross connections (with barrier)



- For HMD.2 and FDP.2 terminal blocks

TERMINAL BLOCK	JUMPER TYPE	CODE
HMD.2	PH/2.5-4	PH100
FDP.2	PH/2.5-4	PH100

(1) to complete the insertion of the jumpers, the use of screwdriver is necessary



PH JUMPER

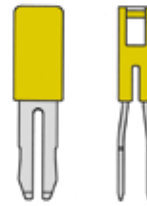

PHD/2 JUMPER



HMD.2/6R CAT. NO. HD100GR

FOR MINI SPRING-CLAMP TERMINAL BLOCKS

TERMINAL BLOCK	2-POLE JUMPER		3-POLE JUMPER		5-POLE JUMPER	
	TYPE	CODE	TYPE	CODE	TYPE	CODE
HP.2/P	PTC/2/02	PTC0202	PTC/2/03	PTC0203	PTC/2/05	PTC0205
HPC.2/P	PTC/2/02	PTC0202	PTC/2/03	PTC0203	PTC/2/05	PTC0205
HPP.2/P	PTC/2/02	PTC0202	PTC/2/03	PTC0203	PTC/2/05	PTC0205



FOR EFC TERMINAL BLOCKS

TERMINAL BLOCK	COLOUR	2-POLE JUMPER		3-POLE JUMPER		5-POLE JUMPER		10-POLE JUMPER	
		TYPE	CODE	TYPE	CODE	TYPE	CODE	TYPE	CODE
EFC.2 SERIES	Red	EFB.2/2/R	EFB0202R	EFB.2/3/R	EFB0203R	EFB.2/5/R	EFB0205R	EFB.2/10/R	EFB0210R
	Blue	EFB.2/2/B	EFB0202B	EFB.2/3/B	EFB0203B	EFB.2/5/B	EFB0205B	EFB.2/10/B	EFB0210B
EFCE.2 SERIES	Red	EFB.2/2/R	EFB0202R	EFB.2/3/R	EFB0203R	EFB.2/5/R	EFB0205R	EFB.2/10/R	EFB0210R
	Blue	EFB.2/2/B	EFB0202B	EFB.2/3/B	EFB0203B	EFB.2/5/B	EFB0205B	EFB.2/10/B	EFB0210B
EFC.4 SERIES	Red	EFB.4/2/R	EFB0402R	EFB.4/3/R	EFB0403R	EFB.4/5/R	EFB0405R	EFB.4/10/R	EFB0410R
	Blue	EFB.4/2/B	EFB0402B	EFB.4/3/B	EFB0403B	EFB.4/5/B	EFB0405B	EFB.4/10/B	EFB0410B
EFCE.4 SERIES	Red	EFB.4/2/R	EFB0402R	EFB.4/3/R	EFB0403R	EFB.4/5/R	EFB0405R	EFB.4/10/R	EFB0410R
	Blue	EFB.4/2/B	EFB0402B	EFB.4/3/B	EFB0403B	EFB.4/5/B	EFB0405B	EFB.4/10/B	EFB0410B
EFD.2 SERIES	Red	EFB.2/2/R	EFB0202R	EFB.2/3/R	EFB0203R	EFB.2/5/R	EFB0205R	EFB.2/10/R	EFB0210R
	Blue	EFB.2/2/B	EFB0202B	EFB.2/3/B	EFB0203B	EFB.2/5/B	EFB0205B	EFB.2/10/B	EFB0210B
EFD.4 SERIES	Red	EFB.4/2/R	EFB0402R	EFB.4/3/R	EFB0403R	EFB.4/5/R	EFB0405R	EFB.4/10/R	EFB0410R
	Blue	EFB.4/2/B	EFB0402B	EFB.4/3/B	EFB0403B	EFB.4/5/B	EFB0405B	EFB.4/10/B	EFB0410B
EFDE SERIES	Red	EFB.2/2/R	EFB0202R	EFB.2/3/R	EFB0203R	EFB.2/5/R	EFB0205R	EFB.2/10/R	EFB0210R
	Blue	EFB.2/2/B	EFB0202B	EFB.2/3/B	EFB0203B	EFB.2/5/B	EFB0205B	EFB.2/10/B	EFB0210B
EFDE SERIES	Red	EFB.4/2/R	EFB0402R	EFB.4/3/R	EFB0403R	EFB.4/5/R	EFB0405R	EFB.4/10/R	EFB0410R
	Blue	EFB.4/2/B	EFB0402B	EFB.4/3/B	EFB0403B	EFB.4/5/B	EFB0405B	EFB.4/10/B	EFB0410B
EFF.4 SERIES	Red	EFB.4/2/R	EFB0402R	EFB.4/3/R	EFB0403R	EFB.4/5/R	EFB0405R	EFB.4/10/R	EFB0410R
	Blue	EFB.4/2/B	EFB0402B	EFB.4/3/B	EFB0403B	EFB.4/5/B	EFB0405B	EFB.4/10/B	EFB0410B
EFS SERIES	Red	EFB.2/2/R	EFB0202R	EFB.2/3/R	EFB0203R	EFB.2/5/R	EFB0205R	EFB.2/10/R	EFB0210R
	Blue	EFB.2/2/B	EFB0202B	EFB.2/3/B	EFB0203B	EFB.2/5/B	EFB0205B	EFB.2/10/B	EFB0210B
EFS SERIES	Red	EFB.4/2/R	EFB0402R	EFB.4/3/R	EFB0403R	EFB.4/5/R	EFB0405R	EFB.4/10/R	EFB0410R
	Blue	EFB.4/2/B	EFB0402B	EFB.4/3/B	EFB0403B	EFB.4/5/B	EFB0405B	EFB.4/10/B	EFB0410B
EFT.2 SERIES	Red	EFB.2/2/R	EFB0202R	EFB.2/3/R	EFB0203R	EFB.2/5/R	EFB0205R	EFB.2/10/R	EFB0210R
	Blue	EFB.2/2/B	EFB0202B	EFB.2/3/B	EFB0203B	EFB.2/5/B	EFB0205B	EFB.2/10/B	EFB0210B
EFD.2 SERIES	Red	EFB.2/2/R	EFB0202R	EFB.2/3/R	EFB0203R	EFB.2/5/R	EFB0205R	EFB.2/10/R	EFB0210R
	Blue	EFB.2/2/B	EFB0202B	EFB.2/3/B	EFB0203B	EFB.2/5/B	EFB0205B	EFB.2/10/B	EFB0210B



They enable cross connection of two adjacent terminal blocks and are placed in an accident prevention position with respect to the outside.

The POF is made up of:

- 2 screws
- 2 sleeves (except POF/95/..., POF/150/..., POF/240/..)
- 1 plate with 2 holes

All the components are in brass, with nickel plating.



TERMINAL BLOCK	JUMPER TYPE	CODE	SCREW M X L (MM)	SLEEVE Ø X L (MM)	PLATE L X S (MM)
CBC.16	POF/53	POF53	M4 x 21	8 x 15	7 x 1.5
CBC.35	POF/35	POF35	M4 x 21	8 x 12	10 x 4
CBD.16	POF/44	POF44	M4 x 16	6 x 9.5	7 x 1.5
CBD.35	POF/06	POF06	M4 x 21	8 x 12	8 x 2.5
CBD.50	POF/07	POF07	M5 x 20	8 x 12	10 x 2,5
CBD.70	POF/08	POF08	M5 x 25	8 x 15	10 x 2,5
SCB.6	POF/57	POF57	M3.5 x 28	6 x 19	7 x 1
SCB.10	POF/56	POF56	M4.5 x 20	7 x 13.5	7 x 1.5
GPM.95 (2 poles)	POF/95/2	PO952	M5 x 20	-	10 x 10
GPM.95 (3 poles)	POF/95/3	PO953	M5 x 20	-	10 x 10
GPM.150 (2 poles)	POF/150/2	PO152	M5 x 20	-	10 x 10
GPM.150 (3 poles)	POF/150/3	PO153	M5 x 20	-	10 x 10
GPM.240 (2 poles)	POF/240/2	PO242	M5 x 30	-	10 x 15
GPM.240 (3 poles)	POF/240/3	PO243	M5 x 30	-	10 x 15
GPA.70 - GPA.70/FIX	POF/70	POF70	M5 x 35	8 x 23.5	10 x 3

(1) For terminal blocks that normally require POF connections, where they are to be inserted in "increased safety" installations (Ex e), the use of PFX cross connections is required; they include an anti-loosening washer

The PMP commoning bar, suitable for multiple connection of several terminal blocks, whether adjacent or not, is supplied in 250 mm sections with holes adequate for the pitch of each terminal block. The bar is supported and fixed, in correspondence with each element, by a special CPM sleeve screw.

In use on terminal boards destined for "increased safety" (Ex e) plants the CPM screws/sleeves are fitted with self-locking washers and their part number is changed to CPX.



TERMINAL BLOCK	COMMONING BAR		L X S MM	SCREW/SLEEVE		SCREW/SLEEVE (EX E)	
	TYPE	CODE		TYPE	CODE	TYPE	CODE
CBC.16	PMP/05	PMP05	7 x 1.5	CPM/53	CPM53	CPX/53	CPX53
CBC.35	PMP/35	PMP35	10 x 4	CPM/35	CPM35	CPX/35	CPX35
CBD.2	PMP/01	PMP01	5.5 x 0.6	CPM/21	CPM21	CPX/21	CPX21
CBD.4	PMP/42	PMP42	5.5 x 0.6	CPM/12	CPM12	CPX/12	CPX12
CBD.6	PMP/13	PMP13	7 x 1	CPM/83	CPM83	CPX/83	CPX83
CBD.10	PMP/04	PMP04	7 x 1.5	CPM/03	CPM03	CPX/03	CPX03
CBD.16	PMP/05	PMP05	7 x 1.5	CPM/44	CPM44	CPX/44	CPX44
CBD.35	PMP/06	PMP06	8 x 2.5	CPM/06	CPM06	CPX/06	CPX06
CBD.50	PMP/07	PMP07	10 x 2.5	CPM/07	CPM07	CPX/07	CPX07
CBD.70	PMP/08	PMP08	10 x 2.5	CPM/08	CPM08	CPX/08	CPX08
CBR.2	PMP/25	PMP25	5.5 x 0.6	CPM/25	CPM25	-	-
CVF.4	PMP/58	PMP58	5.5 x 0.6	CPM/12	CPM12	-	-
DAS.4	PMP/58	PMP58	5.5 x 0.6	CPM/01	CPM01	CPX/01	CPX01
FFS.4	PMP/42	PMP42	5.5 x 0.6	CPM/01	CPM01	CPX/01	CPX01
FVS.4	PMP/42	PMP42	5.5 x 0.6	CPM/01	CPM01	CPX/01	CPX01
GPA.70 - GPA.70/FIX	PMP/08	PMP08	10 x 2.5	CPM/70	CPM70	-	-
RN.1	PMP/16	PMP16	5.5 x 0.6	CPM/16	CPM16	-	-
RN.2	PMP/25	PMP25	5.5 x 0.6	CPM/16	CPM16	CPX/16	CPX16
RP.4	PMP/58	PMP58	5.5 x 0.6	CPM/01	CPM01	CPX/01	CPX01
SCB.4	PMP/02	PMP02	5.5 x 0.6	CPM/01	CPM01	-	-
SCB.6	PMP/13	PMP13	7 x 1	CPM/57	CPM57	-	-
SCB.10	PMP/56	PMP56	7 x 1.5	CPM/56	CPM56	-	-
TDE.2	PMP/02	PMP02	5.5 x 0.6	CPM/21	CPM21	-	-
TLD.2	PMP/02	PMP02	5.5 x 0.6	CPM/21	CPM21	-	-
TLE.2	PMP/02	PMP02	5.5 x 0.6	CPM/21	CPM21	-	-
TLS.2	PMP/02	PMP02	5.5 x 0.6	CPM/21	CPM21	-	-

If the linking of adjacent terminal blocks is occasional, a POS switchable cross connection may be used; it consists of:

- 2 screws
- 2 sleeves
- 1 linking plate with open slot, allowing easy opening and closing of the cross connection



TERMINAL BLOCK	CROSS CONNECTION		SCREW M X L (MM)	SLEEVE Ø X L (MM)
	TYPE	CODE		
CBC.16	POS/53	POS53	4 x 35	5.1 x 30
CBD.2	POS/11	POS11	2.5 x 22	4 x 18
CBD.4	POS/42	POS42	3 x 28	4 x 23
CBD.6	POS/93	POS93	3.5 x 27	5.5 x 21.5
CBD.10	POS/44	POS44	4 x 30	5.5 x 21.5
CBD.16	POS/44	POS44	4 x 30	5.5 x 21.5
CBD.35	POS/66	POS66	4 x 30	8 x 23.5
CBD.50	POS/77	POS77	5 x 30	8 x 23.5
CBD.70	POS/08	POS08	5 x 40	8 x 30
DAS.4	POS/43	POS43	3 x 20	4 x 16
FFS.4	POS/72	POS72	3 x 20	4 x 14.5
FVS.4	POS/72	POS72	3 x 20	4 x 14.5
TLD.2	POS/41	POS41	2.5 x 16	4 x 12.7
TLS.2	POS/41	POS41	2.5 x 16	4 x 12.7
RP.4	POS/43	POS43	3 x 20	4 x 16
SCB.4	POS/12	POS12	3x22	4x18

The modular test plugs make it possible to carry out the final check on terminal boards already wired or a simple derivation. The tester is positioned directly in the housing of the terminal block like a normal test plug. The extreme simplicity of the modularity makes it possible to assemble the tester in a number of poles according to the various needs.



MODULAR TEST PLUGS FOR SCREW CLAMP TERMINAL BLOCKS

CODE TYPE	DD005 SDD/5	DD006 SDD/6	DD501 SD5/PT	DD601 SD6/PT
DESCRIPTION	pitch 5.5 mm. for terminal blocks type CBD.2	pitch 6.5 mm. for terminal blocks type CBD.4	closing element for SDD/5	closing element for SDD/6

CODE TYPE	DC005 SDC/5	DC006 SDC/6	DC05P SDC/5P	DC06P SDC/6P
DESCRIPTION	pitch 5 mm. for terminal blocks type CBC.2/GR	pitch 6 mm. for terminal blocks type CBC.4/GR	version to be used with PTC jumper	version to be used with PTC jumper

CODE TYPE	DC05V SDC/5V	DC06V SDC/6V	DCPOL SDC/POL
DESCRIPTION	intermediate distancing element	intermediate distancing element	polarising element



SDD

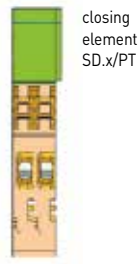

closing element SD.x/PT



SDC/6 once mounted



SDC/6-P once mounted



SDC/6 with cable composition

TEST PLUGS FOR SPRING-CLAMP TERMINAL BLOCKS

CODE TYPE	DH004 SDH/4	DH005 SDH/5	DH006 SDH/6	DH007 SDH/7
DESCRIPTION	pitch 4.2 mm for terminal blocks: HMM.1, HMM.1/1+2, HMM.1/2+2, HMD.1	pitch 5.2 mm for terminal blocks HMM.2 - HMM.2/1+2 - HMM.2/2+2 - HMD.2 - HMS.2 - HP.2 Series - HP.2/P	pitch 6.2 mm for HMM.4 terminal blocks	pitch 5.2 mm for terminal blocks HMD.2N/GR, HMD.2N/X/GR, HMD.2N/X1/GR

CODE TYPE	DH401 SH4/PT	DH501 SH5/PT	DH601 SH6/PT	DH701 SH7/PT
DESCRIPTION	closing element for SDH/4	closing element for SDH/5	closing element for SDH/6	closing element for SDH/7

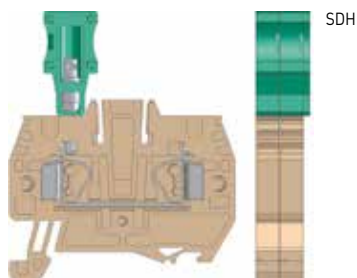

SDH

For measurements and checks on circuits which are related to the terminal boards,

the following special items can be supplied:

- insulated sockets (PSD) screwable onto the conductor body of the terminal blocks.
- plugs (SDD) of the bundle type, made of silver-plated brass.



TERMINAL BLOCK	SOCKET		INTERNAL SOCKET Ø (MM)	PLUG		PLUG Ø (MM)
	TYPE	CODE		TYPE	CODE	
CBC.16	PSD/B	PD002	4.05	SDD/2	DD002	4
CBC.35	PSD/B	PD002	4.05	SDD/2	DD002	4
CBD.2	PSD/D	PD004	2.35	SDD/1	DD001	2.3
CBD.4	PSD/A	PD001	2.35	SDD/1	DD001	2.3
CBD.6	PSD/N	PD013	2.35	SDD/1	DD001	2.3
CBD.10	PSD/B	PD002	4.05	SDD/2	DD002	4
CBD.16	PSD/B	PD002	4.05	SDD/2	DD002	4
CBD.35	PSD/B	PD002	4.05	SDD/2	DD002	4
CBD.50	PSD/C	PD003	4.05	SDD/2	DD002	4
CBD.70	PSD/C	PD003	4.05	SDD/2	DD002	4
CBR.2	PSD/K	PD011	2.35	SDD/1	DD001	2.3
CVF.4	PSD/A	PD001	2.35	SDD/1	DD001	2.3
DAS.4	PSD/A	PD001	2.35	SDD/1	DD001	2.3
FDP.2	-	-	-	SDD/1	DD001	2.3
FFS.4	PSD/A	PD001	2.35	SDD/1	DD001	2.3
FPC.10	-	-	-	SDD/2	DD002	4
FVS.4	PSD/A	PD001	2.35	SDD/1	DD001	2.3
HMD.2	-	-	-	SDD/1	DD001	2.3
HMM.2	-	-	-	SDD/1	DD001	2.3
HMM.2/1+2	-	-	-	SDD/1	DD001	2.3
HMM.2/2+2	-	-	-	SDD/1	DD001	2.3
HMM.2/1+2/S	-	-	-	SDD/1	DD001	2.3
HMM.2/2+2/S	-	-	-	SDD/1	DD001	2.3
HMM.4	-	-	-	SDD/1	DD001	2.3
HMM.4/1+2	-	-	-	SDD/1	DD001	2.3
HMM.4/2+2	-	-	-	SDD/1	DD001	2.3
HMM.6	-	-	-	SDD/1	DD001	2.3
HMM.10	-	-	-	SDD/1	DD001	2.3
HMM.16	-	-	-	SDD/1	DD001	2.3
HMS.2	-	-	-	SDD/1	DD001	2.3
HTE.2	-	-	-	SDD/1	DD001	2.3
HSCB.6	PSD/O	PD017	2.35	SDD/1	DD001	2.3
HTE.2/1+2	-	-	-	SDD/1	DD001	2.3
HTE.2/2+2	-	-	-	SDD/1	DD001	2.3
HTE.4	-	-	-	SDD/1	DD001	2.3
HTE.6	-	-	-	SDD/1	DD001	2.3
HVPC.2	-	-	-	SDD/1	DD001	2.3
MAC.6	-	-	-	SDD/1	DD001	2.3
RN.1	PSD/K	PD011	2.35	SDD/1	DD001	2.3
RN.2	PSD/A	PD001	2.35	SDD/1	DD001	2.3
RP.4	PSD/A	PD001	2.35	SDD/1	DD001	2.3
SCB.4	PSD/A	PD001	2.35	SDD/6-SDD/1	DD006-DD001	2.3
SCB.6	PSD/P	PD015	4.05	SDD/2	DD002	4
SCB.10	PSD/L	PD009	4.05	SDD/2	DD002	4
SFC.10	-	-	-	SDD/2	DD002	4
SFR.4	PSD/J	PD014	2.35	SDD/1	DD001	2.3
TDE.2	PSD/D	PD004	2.35	SDD/1	DD001	2.3
TLD.2	PSD/D	PD004	2.35	SDD/1	DD001	2.3
TLE.2	PSD/D	PD004	2.35	SDD/1	DD001	2.3
TLS.2	PSD/D	PD004	2.35	SDD/1	DD001	2.3

- CPF05 can be mounted on MPFA.4, DSFA.4 and HMFA.2 terminal blocks
- CPFE02 and CPFE04 can be mounted on EFS and EFDS series
- possible insertion of $\varnothing 5 \times 20$ mm fuse (our type F5), with or without warning LED, diode (1 or 3 A), and other components (e.g. resistances)



(1) with fuse $\varnothing 5 \times 20$ mm, 250 V, $I_{max} = 6,3$ A – with brass pin $I_{max} = 10$ A
 (2) the height depends on the mounting on relative terminal blocks and the din rail (see table)

GREEN VERSION	CODE TYPE	CPF05	CPFE02	CPFE04
		CPF/5	CPFE/2	CPFE/4

TECHNICAL CHARACTERISTICS

Function/type		component holder cartridge	component holder cartridge	component holder cartridge
Electrical characteristics	Max AC/DC Voltage	320 (1)	630 (1)	630 (1)
According to European standard IEC EN 60947-7-1	Max current with rated cross-section	6,3 (1)	6,3 (1)	6,3 (1)
	Section	-	-	-
Rated impulse withstand voltage/pollution degree		4 kV / 3	4 kV / 3	4 kV / 3
Width	(mm)	33	30	30
Length	(mm)	6	6	6
Height mounted on TH35/7,5	(mm)	(2)	(2)	(2)
Height mounted on TH35/15	(mm)	(2)	(2)	(2)
Height mounted on G32	(mm)	(2)	(2)	(2)
Insulation material temperature index [EN 60216-1]	(°C)	130	130	130
Plastic material		polyamide UL94V-0	polyamide UL94V-0	polyamide UL94V-0

APPROVALS



ACCESSORIES			
Marking tag		CNU/8/51 (cod. NU0851S)	CNU/8/51 (cod. NU0851S)
Tinned brass conductor		CO/5 (cod. VL103)	-
Cartridge / insert with 1 A diode		SFR/I1A (cod. SF992)	SFR/I1A (cod. SF992)
Cartridge / insert with 3 A diode		SFR/I3A (cod. SF993)	SFR/I3A (cod. SF993)
LED circuit non-polarized	for voltage 12V 24V 48V AC/DC	-	CIL/12-24-48 (cod. SF518)
	for voltage 115V 230V AC/DC	-	CIL/115-230 (cod. SF510)
VERSIONS PROVIDED			
With non-polarized LED microcircuit 12 Vdc / Vac		CPF/5L12 (cod. CPF512)	-
With non-polarized LED microcircuit 24 Vdc / Vac		CPF/5L24 (cod. CPF524)	-
With non-polarized LED microcircuit 48 Vdc / Vac		CPF/5L48 (cod. CPF548)	-
With non-polarized LED microcircuit 115 Vdc / Vac		CPF/5L115 (cod. CPF511)	-
With non-polarized LED microcircuit 230 Vdc / Vac		CPF/5L230 (cod. CPF523)	-
With 1 A diode (1N4001 ÷ 1N4007 types)		CPF/5D1A (cod. CPF501)	-
With 3 A diode (BY255 type)		CPF/5D3A (cod. CPF503)	-
With resistor 1200 Ω (1 W \pm 5%)		CPF/5R (cod. CPR05)	-

Terminal block	Height on rail TH/35 7.5 (mm)	Height on rail TH/35 15 (mm)	Height on rail G32 (mm)
HMFA.2	57	75	-
MPFA.4	75	83	79
DSFA.4	96	104	100
EFS.2	61.2	68.7	-
EFS.4	61.2	68.7	-
EFDS.2/GR	74	81.5	-
EFDS.2/1S/GR	74	81.5	-

MAX. DISSIPATED POWER - IN CONF. WITH IEC 60947-7-3

Terminal block	Voltage [V] (*)	Current [A]	Protection against overload and short circuit		Only protection against short circuit	
			Single configuration (PV) - [W]	Composite configuration (PV) - [W]	Single configuration (PVK) - [W]	Composite configuration (PVK) - [W]
MPFA.4 + CPF/5	250	6.3	1.6	1.6	4	1.6
DSFA.4 + CPF/5	250	6.3	1.6	1.6	4	1.6
HMFA.2 + CPF/5	250	6.3	1.6	1.6	4	1.6

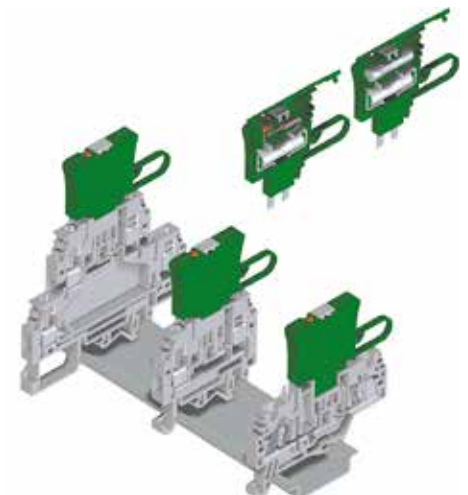

TYPE	CODE		
SCB/6/ PO/2	SB203	Short circuit plate for two adjacent SCB.6 terminal blocks	
SCB/6/ PO/4	SB204	Short circuit plate for four adjacent SCB.6 terminal blocks	
HSCB/6/ PO/2	HB203	Short circuit plate for two adjacent HSCB.6 terminal blocks	
HSCB/6/ PO/4	HB204	Short circuit plate for four adjacent HSCB.6 terminal blocks	
SCB/4/ PO/2	SB303	Short circuit plate for two adjacent SCB.4 terminal blocks	
SCB/4/ PO/4	SB304	Short circuit plate for four adjacent SCB.4 terminal blocks	
SCX/PO/2	SC103	Short circuit plate for two adjacent SCX.10 terminal blocks	
SCX/PO/4	SC104	Short circuit plate for four adjacent SCX.10 terminal blocks	
FVS/VCI	FV107	Screw and sleeve to perform the internal link between the front and back conducting bodies of FVS.4 terminal block	
FVS/VCE	FV108	Screw and sleeve to perform the internal and external link between the front and back conducting bodies of FVS.4 terminal blocks.	

TYPE	CODE		
DAS/VCI	DS107	Screw and sleeve for internal connection between the front conductor body and the rear one of the DAS.4	
DAS/VCE	DS108	Screw and sleeve for internal connection between the front and rear conductor bodies and external connection between the conductor bodies of contiguous terminal blocks, for the DAS.4	
CO/5	VL103	Ø 5 x 20 mm - in brass for terminal block types: SFO.4 - SFR.4 - SFR.6/M - FLD.10/F5 - HMF.4 - VLM.10	
SFC/CO	FC102	Ø 6,3 x 32 mm - in brass for terminal block types: FPC.10 - SFC.10 - SFR.6 - with possible derivation by means of plug SDD/2	
CBD/SH	CB009	For the connection of the cable shielding - to be used on terminal blocks type CBD.2, 4, 6, 10.	
SCB/6/ CPM	SB205	Sleeve to be used with SCB/6/ PO link	
HSCB.6/ CPM	HB205	Sleeve to be used with HSCB/6/ PO link	
SCB/4/ CPM	SB305	Sleeve to be used with SCB/4/ PO link	
SCX/CPM	SC105	Sleeve to be used with SCX/PO link (*)	

(*) they are supplied mounted as in A. It is necessary to remove, as in pos. B, the one to introduce into the platelet slot, put it back and screw it onto the body of the terminal block.

According to the IEC 60127-2-1- standard with rapid burn-out for voltage 250 V. In small steatite tube filled with spark-quenching powder (interruption power 1500 A).



RATED CURRENT	Ø 5 X 20 MM FUSE WITHOUT MARKING		APPROVALS
	TYPE	CODE	
100 mA	F5/100 mA	FN001ST	-
200 mA	F5/200 mA	FN002ST	-
315 mA	F5/315 mA	FN003ST	-
500 mA	F5/500 mA	FN004ST	RINA 5/18/75 homologation - 220V - 50 Hz - 1500 A
630 mA	F5/630 mA	FN005ST	RINA 5/18/75 homologation - 220V - 50 Hz - 1500 A
1A	F5/1 A	FN006ST	RINA 5/18/75 homologation - 220V - 50 Hz - 1500 A
1.6 A	F5/1.6 A	FN007ST	RINA 5/18/75 homologation - 220V - 50 Hz - 1500 A
2A	F5/2 A	FN008ST	RINA 5/18/75 homologation - 220V - 50 Hz - 1500 A
2.5 A	F5/2.5 A	FN009ST	RINA 5/18/75 homologation - 220V - 50 Hz - 1500 A
3.15 A	F5/3.15 A	FN010ST	RINA 5/18/75 homologation - 220V - 50 Hz - 1500 A
4A	F5/4 A	FN011ST	RINA 5/18/75 homologation - 220V - 50 Hz - 1500 A
5A	F5/5 A	FN012ST	RINA 5/18/75 homologation - 220V - 50 Hz - 1500 A
6.3 A	F5/6.3 A	FN013ST	RINA 5/18/75 homologation - 220V - 50 Hz - 1500 A
8A	F5/8 A	FN014ST	RINA 5/18/75 homologation - 220V - 50 Hz - 1500 A
10A	F5/10 A	FN015ST	RINA 5/18/75 homologation - 220V - 50 Hz - 1500 A
12A	F5/12 A	FN016ST	RINA 5/18/75 homologation - 220V - 50 Hz - 1500 A

LSN TORPEDO PILOT BULBS F5 FUSES

CODE	TECHNICAL CHARACTERISTIC
FL201	Festoon light bulb Ø 6 x 26 mm, with stabiliser resistance incorporated, for voltage between 12 V AC and 48 V AC, for use on FLD.10/F5L, FLD.10/F6, FPL.10 terminal blocks.
FL202	Festoon light bulb Ø 6 x 26 mm, with stabiliser resistance incorporated, for voltage between 70 V AC and 380 V AC, for use on FLD.10/F5L, FLD.10/F6, FPL.10 terminal blocks.
KIT1224	For SFR.6 and SFR.6/M terminal blocks.
KIT70380	For SFR.6 and SFR.6/M terminal blocks.



CIL SIGNAL CIRCUIT

For signalling the status of fuse-holder terminal blocks types SFR.4 - DSF.4 - FPL.10/C - HFR.4. Suitable for use in circuits powered both in D.C. and A.C. Each packet is supplied with:

- two contact blades
- one nonpolarized LED microcircuit
- one transparent protection.

The components are inserted inside the terminal block in this sequence

TYPE	CODE	RATED VOLTAGE [V DC - V AC]	CURRENT L R.M.S. [A] [*]
CIL/12-48	SF518	12-48	3.0 mA
CIL/115-230	SF510	115-230	2.3 mA
CIL/12-48	HF518	12-48	3.0 mA
CIL/115-230	HF510	115-230	2.3 mA

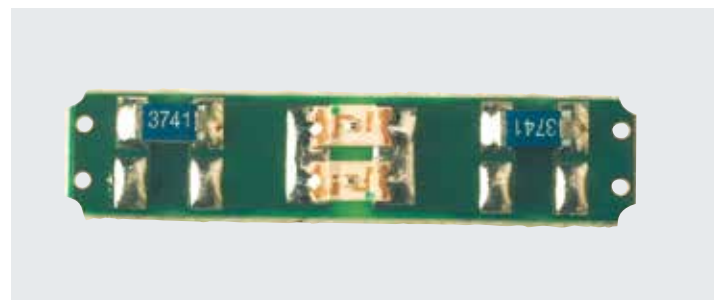

Made of red polyamide, thickness 1.5 mm, to be placed to separate the elements on the terminal board to enable easy identification of certain circuits or to increase the insulation distances between the terminal blocks. The partitions can also be used to increase the insulation distances between adjacent cross connections or multiple parallel platelets.

NOTE

[1] q dimension can be obtained by adding 4 mm to dimension p
[2] r dimension can be obtained by adding 7.5 mm to dimension p

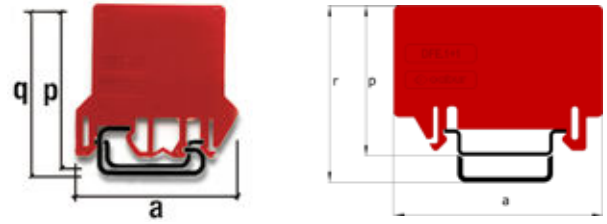

TERMINAL BLOCK	PARTITION		DIMENSIONS A X P
	TYPE	CODE	
SCREW-CLAMP TERMINAL BLOCKS			
AFO.2/1+1	DFU/1/R	DU01R	52 x 51
AFO.2/2+2	DFU/1/R	DU01R	52 x 51
CBC.2	DFU/4/R	DU04R	52 x 62
CBC.4	DFU/4/R	DU04R	52 x 62
CBC.6	DFU/4/R	DU04R	52 x 62
CBC.10	DFU/4/R	DU04R	52 x 62
CBC.16	DFU/4/R	DU04R	52 x 62
CBC.35	DFU/5/R	DU05R	62 x 68
CBD.2	DFU/1/R	DU01R	52 x 51
CBD.4	DFU/4/R	DU04R	52 x 62
CBD.6	DFU/4/R	DU04R	52 x 62
CBD.10	DFU/4/R	DU04R	52 x 62
CBD.16	DFU/4/R	DU04R	52 x 62
CBD.35	DFU/5/R	DU05R	62 x 68
CBD.50	DFU/5/R	DU05R	62 x 68
CBD.70	DFU/6/R	DU06R	72 x 74
CBE.2	DFU/4/R	DU04R	52 x 62
CBR.2	DFU/4/R	DU04R	52 x 62
CVF.4	DFU/3/R	DU03R	68 x 57
DAS.4	DFU/7/R	DU07R	80 x 64
DBC.2	DFU/7/R	DU07R	80 x 64
DSF.4	DFU/7/R	DU07R	80 x 64
DSFA.4	DFU/7/R	DU07R	80 x 64
DSS.4	DFU/7/R	DU07R	80 x 64
FDP.2	DFU/5/R	DU05R	62 x 68
FLD.10/...	DFU/6/R	DU06R	72 x 74
FPC.10	DFU/6/R	DU06R	72 x 74
FPL.10	DFU/6/R	DU06R	72 x 74
FVS.4	DFU/6/R	DU06R	72 x 74
MPFA.4	DFU/3/R	DU03R	68 x 57
NCS	DFU/2/R	DU02R	52 x 54
NCV	DFU/2/R	DU02R	52 x 54
PDF.2	DFU/5/R	DU05R	62 x 68
RFI.2	DFP/2/R	DFP2R	37 x 38
RN.1	DFP/2/R	DFP2R	37 x 38
RN.2	DFP/2/R	DFP2R	37 x 38
RP.4	DFP/2/R	DFP2R	37 x 38
SCB.4	DFU/3/R	DU03R	68 x 57
SCB.6	DFU/6/R	DU06R	72 x 74
SCB.6/DD	DFU/6/R	DU06R	72 x 74
SCB.10	DFU/7/R	DU07R	80 x 64
SCB.10/CD	DFU/7/R	DU07R	80 x 64
SCB.10/DD	DFU/7/R	DU07R	80 x 64
SCB.6/CD	DFU/6/R	DU06R	72 x 74
SFR.4	DFU/3/R	DU03R	68 x 57
SFR.6	DFU/7/R	DU07R	80 x 64
TC/PO	DFU/1/R	DU01R	52 x 51
TDE.2	DFU/3/R	DU03R	68 x 57
TLD.2	DFU/3/R	DU03R	68 x 57
TLE.2	DFU/3/R	DU03R	68 x 57
TLS.2	DFU/3/R	DU03R	68 x 57
VPC.2	DFU/5/R	DU05R	62 x 68
VPD.2	DFU/7/R	DU07R	80 x 64

TERMINAL BLOCK	PARTITION		DIMENSIONS A X P
	TYPE	CODE	
SPRING-CLAMP TERMINAL BLOCKS			
HCD.1	DFU/7/R	DU07R	80 x 64
HMD.2	DFH/4/R	DH04R	97 x 51.5
HFR.4	DFH/4/R	DH04R	97 x 51.5
HMFA.2	DFH/2/R	DH02R	76 x 42.5
HMM.2	DFH/1/R	DH01R	64 x 42.5
HMM.2/1+2	DFH/2/R	DH02R	76 x 42.5
HMM.2/2+2	DFH/3/R	DH03R	88 x 42.5
HMM.2/2+2/S	DFH/3/R	DH03R	88 x 42.5
HMM.4	DFH/1/R	DH01R	64 x 42.5
HMM.4/1+2	DFH/4/R	DH04R	97 x 51.5
HMM.4/2+2	DFH/4/R	DH04R	97 x 51.5
HMM.6	DFH/1/R	DH01R	64 x 42.5
HMM.10	DFH/4/R	DH04R	97 x 51.5
HMM.16	DFH/4/R	DH04R	97 x 51.5
HVPC.2	DFH/1/R	DH01R	64 x 42.5
HMS.2	DFH/2/R	DH02R	76 x 42.5
HPP.2	DFP/2/R	DFP2R	37 x 38
HPP.2/P	DFP/2/R	DFP2R	37 x 38
HTE.2	DFH/1/R	DH01R	64 x 42.5
HTE.2/1+1	DFH/2/R	DH02R	76 x 42.5
HTE.2/2+2	DFH/3/R	DH03R	88 x 42.5
HTE.4	DFH/1/R	DH01R	64 x 42.5
HTE.6	DFH/1/R	DH01R	64 x 42.5
HMM.1	DFH/1/R	DH01R	64 x 42.5
HMM.1/1+2	DFH/3/R	DH03R	88 x 42.5
HMM.1/2+2	DFH/2/R	DH02R	76 x 42.5
HMD.1	DFU/7/R	DU07R	80 x 64
HMD.2N	DFU/7/R	DU07R	80 x 64
HMM.2/1+2/S	DFH/2/R	DH02R	76 x 42.5
HSCB.4	DFH/4/R	DH04R	97 x 51.5
HTE.1	DFH/1/R	DH01R	64 x 42.5
HTE.1/1+2	DFH/2/R	DH02R	76 x 42.5
HTE.1/2+2	DFH/3/R	DH03R	88 x 42.5

TERMINAL BLOCK	PARTITION		DIMENSIONS A X P
	TYPE	CODE	
EFC TERMINAL BLOCKS			
EFC.2	DFE.1+1/R	DFE01R	59.2 x 42.5
EFC.2/1+2	DFE.1+2/R	DFE02R	75.8 x 42.5
EFC.2/2+2	DFE.2+2/R	DFE03R	92.4 x 42.5
EFCE.2	DFE.1+1/R	DFE01R	59.2 x 42.5
EFCE.2/1+2	DFE.1+2/R	DFE02R	75.8 x 42.5
EFCE.2/2+2	DFE.2+2/R	DFE03R	92.4 x 42.5
EFC.4	DFE.1+1/R	DFE01R	59.2 x 42.5
EFC.4/1+2	DFE.1+2/R	DFE02R	75.8 x 42.5
EFC.4/2+2	DFE.2+2/R	DFE03R	92.4 x 42.5
EFCE.4	DFE.1+1/R	DFE01R	59.2 x 42.5
EFCE.4/1+2	DFE.1+2/R	DFE02R	75.8 x 42.5
EFCE.4/2+2	DFE.2+2/R	DFE03R	92.4 x 42.5
efd.2	DFE.2P/R	DFE04R	84.7 x 59.5
efd.2/CI	DFE.2P/R	DFE04R	84.7 x 59.5
efd.2/E	DFE.2P/R	DFE04R	84.7 x 59.5
efd.4	DFE.2P/R	DFE04R	84.7 x 59.5
efd.4/CI	DFE.2P/R	DFE04R	84.7 x 59.5
efd.4/E	DFE.2P/R	DFE04R	84.7 x 59.5
efde.2	DFE.2P/R	DFE04R	84.7 x 59.5
efde.4	DFE.2P/R	DFE04R	84.7 x 59.5
eff.4	DFE.1+1/R	DFE01R	59.2 x 42.5
eff.4/C48	DFE.1+1/R	DFE01R	59.2 x 42.5
eff.4/C230	DFE.1+1/R	DFE01R	59.2 x 42.5
efs.2	DFE.1+1/R	DFE01R	59.2 x 42.5
efs.4	DFE.1+1/R	DFE01R	59.2 x 42.5
EFT.2	-	-	-
EFTE.2	-	-	-
EFT.2/S	-	-	-
EFDS.2	-	-	-
EFDS.2/1S	-	-	-
EFDS.2/P	-	-	-

Made of red polyamide, indispensable for guaranteeing the insulation distance between fixed or switchable cross connections inserted between adjacent pairs of terminal blocks and, in the same way, between multiple parallel platelets, inserted between adjacent groups of terminal blocks.

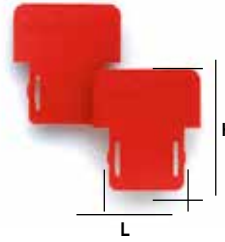

TERMINAL BLOCK	PARTITION		DIMENSIONS L X H	THICKNESS MM
	TYPE	CODE		
CBC.2	DFM/900	DF900	17 x 18	0.5
CBC.2	DFM/800	DF800	17 x 18	0.5
CBC.4	DFM/900	DF900	17 x 18	0.5
CBC.4	DFM/800	DF800	17 x 18	0.5
CBC.6	DFM/900	DF900	17 x 18	0.5
CBC.6	DFM/800	DF800	17 x 18	0.5
CBC.10	DFM/900	DF900	17 x 18	0.5
CBC.10	DFM/800	DF800	17 x 18	0.5
CBC.16	DFM/700	DF700	28 x 32	0.5
CBC.35	DFM/700	DF700	28 x 32	0.5
CBD.2	DFM/600	DF600	24 x 31	0.5
CBD.4	DFM/600	DF600	24 x 31	0.5
CBD.6	DFM/600	DF600	24 x 31	0.5
CBD.10	DFM/700	DF700	28 x 32	0.5
CBD.16	DFM/700	DF700	28 x 32	0.5
CBD.35	DFM/700	DF700	28 x 32	0.5
CBD.50	DFM/700	DF700	28 x 32	0.5
CBD.70	DFM/700	DF700	28 x 32	0.5
DBC.2	DFM/900	DF900	17 x 18	0.5
DBC.2	DFM/800	DF800	17 x 18	0.5
DBC.2	DFM/500	DF500	4.6 x 13.5	0.5
DSS.4	DFM/500	DF500	4.6 x 13.5	0.5
DSFA.4	DFM/500	DF500	4.6 x 13.5	0.5
HDE.2	DFM/500	DF500	4.6x13.5	0.5
HLD.2	DFM/500	DF500	4.6x13.5	0.5
HMM.1	DFM/500	DF500	4.6 x 13.5	0.5
HMM.1/1+2	DFM/500	DF500	4.6 x 13.5	0.5
HMM.1/2+2	DFM/500	DF500	4.6 x 13.5	0.5
HMD.1	DFM/500	DF500	4.6 x 13.5	0.5
HMD.2/N	DFM/500	DF500	4.6 x 13.5	0.5
MPS.4	DFM/500	DF500	4.6 x 13.5	0.5
MPFA.4	DFM/500	DF500	4.6 x 13.5	0.5
TLD.2	DFM/400	DF400	10 x 18	0.5
TLS.2	DFM/400	DF400	10 x 18	0.5
VPC.2	DFM/300	DF300	9.4 x 12.9	0.4
VPD.2	DFM/300	DF300	9.4 x 12.9	0.4

For protecting from accidental contacts or tampering CDA and ACB Series terminal blocks.

Made of self-extinguishing and transparent material of thickness 2.3 mm and fixed length 200 mm (corresponding to the total width of the four terminal blocks side-by-side).

The covers are available in three sizes:

- **PRT/P** 22 x 125 mm [Cat.No. PRT01]
for protecting ACB/BB terminal blocks
- **PRT/M 50** 50 x 125 mm [Cat.No. PRT02]
for protecting ACB/CC terminal blocks
- **PRT/G 85** 85 x 125 mm [Cat.No. PRT03]
to be used when the conductors come from the backboard, or in order to protect a connection point not yet connected.

The PRT covers must be inserted on SPS supports, made of self-extinguishing ABS / class UL94V-0, thickness 5 mm, interposed between contiguous terminal blocks. Protection of the four terminal blocks side-by-side is achieved by means of overlapping coupling of two PRTs.

Note:

The ID Cat. No. (i.e. PRT01) is referred to a single item.

(*) height including rail



PZM.4 COVER

(a = 64+2 mm / b = 32 mm)

Cat. No. **PZ330**

For terminal blocks **of size up to approximately 58 mm** (including rail).

To be mounted with **PZD.4/SO supports** (Cat. No. PZ331)

Maximum size PZM.4 + PZD.4/SO

- on rail IEC 60715/G32 = 70 or 82 mm (*)
- on rail IEC 60715/TH35 = 65 or 77 mm (*)

(*) depending on the notches used, upper or lower.

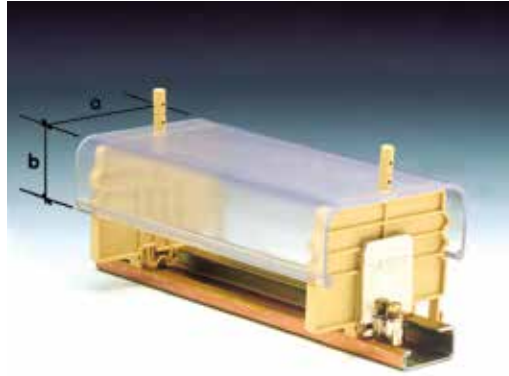

PZM.4 - PZM.6 channel

PZM.6 COVER

(a = 85+2 mm / b = 36 mm)

Cat. No. **PZ110**

For terminal blocks **of size of more than approximately 58 mm** (including rail).

To be mounted with **PZD.6/SO supports** (Cat. No. PZ112)

Maximum size PZM.6 + PZD.6/SO

- on rail IEC 60715/G32 = 82 or 94 mm (*)
- on rail IEC 60715/TH35 = 78 or 90 mm (*)

(*) depending on the notches used, upper or lower.

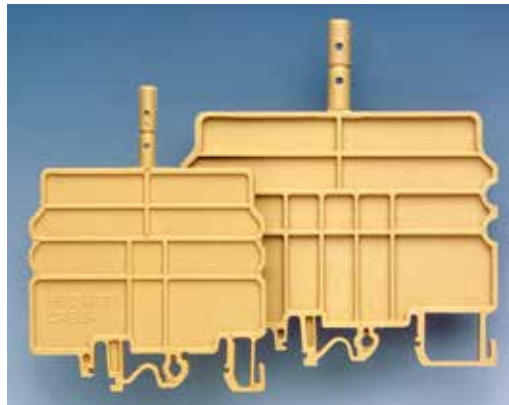

PZD.4/SO - PZD.6/SO supports

Made of **PVC** for protecting from accidental contacts or tampering terminal blocks up to a section of 70 mm².

They are supplied in 2 m lengths and are to be mounted on specific polyamide supports, insertable on PR/DIN and PR/3 support rails, types "G32" and TH/35. They can be made unmovable with sealing of the support appendices.

PRP PROTECTIONS

The cross connection, made up of the PMP multiple commoning bar and CPM screws and sleeves, already located in a position further back with respect to the front of the terminal board, can be further protected against accidental contacts, by means of a U-shaped cover, made of polyamide, with a standard length of 10 cm. The above protection, which is white, can also be used to write words or make reference markings of the terminal board. Special slots are provided on the protection to make it easy to remove using a screwdriver.

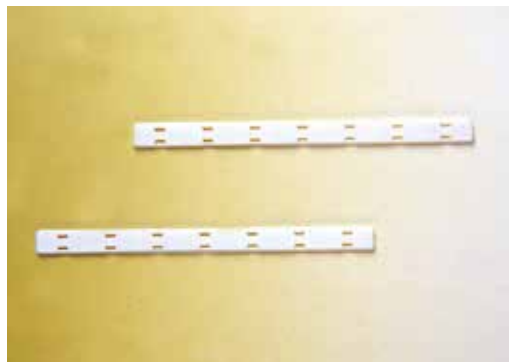

PRP Protections

for terminal blocks of cross section 2.5-4 mm ²	PRP/6	Cat. No. PRP06
for terminal blocks of cross section 4-16 mm ²	PRP/7	Cat. No. PRP07
for terminal blocks of cross section 25-70 mm ²	PRP/8	Cat. No. PRP08
for TLD.2-TLS.2-CBR.2-DAS.4-TLE.2-TDE.2 terminal blocks	PRP/5 (red, blue, white)	Cat. No. PRP05

Made of self-extinguishing material, capable of guarantee the maximum safety of work on terminal boards connected to circuits that are always live. Bearing warning signals and notices, fixable to the terminal blocks by means of two nylon insulating screws, they are available in models of different sizes, according to the type of terminal block. The cover can be tripolar or quadripolar; in some cases the tripolar is made removing a pre-cut part of the quadripolar cover For CBC. 2-4-6-10 terminal blocks the PRP/7/G is supplied; this is without screws, to be inserted in the channels of the cross connections.



TERMINAL BLOCK	WARNING PLATE FOR 3 TERMINAL BLOCKS			WARNING PLATE FOR 4 TERMINAL BLOCKS			SCREW M X L (MM)
	TYPE	CODE	L X H MM	TYPE	CODE	L X H MM	
CBC.2	PRP/7/G	PRP070G	l = 100	PRP/7/G	PRP070G	100	-
CBC.4	PRP/7/G	PRP070G	l = 100	PRP/7/G	PRP070G	100	-
CBC.6	PRP/7/G	PRP070G	l = 100	PRP/7/G	PRP070G	100	-
CBC.10	PRP/7/G	PRP070G	l = 100	PRP/7/G	PRP070G	100	-
CBC.16	TUM/16	TUM16	48 x 34	TUM/16	TUM16	48 x 34	4 x 30
CBC.35	TUM/06	TUM06	63 x 34	TUM/06	TUM06	63 x 34	4 x 30
CBD.2	-	-	-	TQM/02	TQM02	25 x 26	2.5 x 20
CBD.4	TTM/12	TTM12	25 x 26	TTM/12	TTM12	25 x 26	3 x 25
CBD.6	TTM/15	TTM15	25 x 26	TQM/15	TQM15	32 x 26	3.5 x 25
CBD.10	TTM/04	TTM04	32 x 26	TQM/04	TQM04	40 x 26	4 x 25
CBD.16	TUM/05	TUM05	48 x 34	TUM/05	TUM05	48 x 34	4 x 25
CBD.35	TUM/06	TUM06	63 x 34	TUM/06	TUM06	63 x 34	4 x 30
CBD.50	TUM/07	TUM07	72 x 42	TUM/07	TUM07	72 x 42	5 x 30
CBD.70	TUM/08	TUM08	82 x 42	TUM/08	TUM08	82 x 42	5 x 40

[*] to be cut to size

TAI

Possible danger status may be marked using **special triangular self-adhesive labels**

- TAI/6 (Cat. No. TA001)
- TAI/12 (Cat. No. TA002)

to be applied on the protection covers and channels.



MSM HANDLE

For simultaneous switching of several FPL.10 and SFL.10 terminal blocks side-by-side. Supplied in strips of 6 elements.

- MSM (Cat. No. FC103)

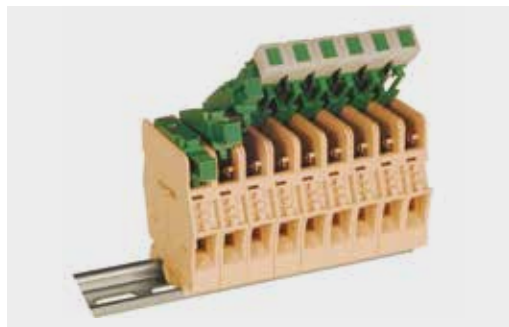

- Possibility of marking 2- and 3-level terminal blocks
- High visibility of the marking
- Available in the 2- and 3-tag version
- Reduced vertical size thanks to high flexibility
- Compatible with all the 2- and 3-level terminal blocks
- Available in grey



VERSION	CODE TYPE	TH02	TH03
		TH/2	TH/3
TECHNICAL CHARACTERISTICS			
function/type		tag holder	tag holder
vertical size	(mm)	19	21
width	(mm)	18	29
thickness	(mm)	4.7	4.7
Usable identification cards	Cabur Jet	C/NU/8/51 (cod. NU0851)	C/NU/8/51 (cod. NU0851)
		C/NU/8/61 (cod. NU0861)	C/NU/8/61 (cod. NU0861)
		C/NU/10/51 (cod. NU1051)	C/NU/10/51 (cod. NU1051)
		C/NU/10/61 (cod. NU1061)	C/NU/10/61 (cod. NU1061)
		C/NU/10/51 (cod. NU1055)	C/NU/10/51 (cod. NU1055)
		C/NU/10/65 (cod. NU1065)	C/NU/10/65 (cod. NU1065)
		C/NU/8/51 (cod. NU0851S)	C/NU/8/51 (cod. NU0851S)
		C/NU/10/51 (cod. NU1051S)	C/NU/10/51 (cod. NU1051S)
		C/NU/10/61 (cod. NU1061S)	C/NU/10/61 (cod. NU1061S)
		C/NU/10/61 (cod. NU1061S)	C/NU/10/61 (cod. NU1061S)
Quantity per pack	(pieces)	50	50

Screwdrivers to activate springs - terminal blocks Series: H
The ergonomic handle guarantees comfort for the entire duration of the work. In addition, each handle has a transparent anti-slip rubber insert, which ensures a good hold over the tool.

CODICE	DESCRIZIONE	LUNGHEZZA
CCH02	0.5 x 3 x 80 mm	160 mm
CCH06	1 x 5.5 x 125 mm	220 mm



CCH/2,5-4

CCH/6

Insulated screwdrivers for voltage up to 1,000 V
The ergonomic handle guarantees comfort for the entire duration of the work. In addition, each handle has a transparent anti-slip rubber insert, which ensures a good hold over the tool.

CODICE	DESCRIZIONE	LUNGHEZZA
CCV03	0.4 x 2.5 x 75 mm	160 mm
CCV04	0.8 x 4 x 100 mm	195 mm
CCV05	1 x 5.5 x 125 mm	220 mm



CCV/2,5

CCV/4

CCV/5

Terminals with sleeves and insulated collars

Series: WP

To connect wires, a complete line of terminals with sleeves, single slot.
Tin-plated electrolytic copper sleeve, insulated with polypropylene.

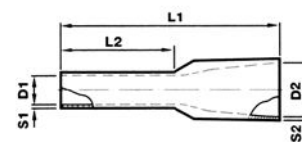

CODICE	DESCRIZIONE	COLORE	SEZIONE	D1	D2	D3	L1	L2	S1	S2	PZ.CONF.
			mm ²	mm	mm	mm	mm	mm	mm	mm	
WP30002	terminal blocks 0.5-14 x 8	White	0,5	1	2,6	-	14	8	0,15	0,25	500
WP30003	terminal blocks 0.5-16 x 10	White	0,5	1	2,6	-	16	10	0,15	0,25	500
WP30005	terminal blocks 0.75-14 x 8	Grey	0,75	1,2	2,8	-	14	8	0,15	0,25	500
WP30006	terminal blocks 0.75-16 x 10	Grey	0,75	1,2	2,8	-	16	10	0,15	0,25	500
WP30009	terminal blocks 1-14 x 8	Red	1	1,4	3	-	14	8	0,15	0,25	500
WP30010	terminal blocks 1-18 x 12	Red	1	1,4	3	-	18	12	0,15	0,25	500
WP30013	terminal blocks 1.5-14 x 8	Black	1,5	1,7	3,5	-	14	8	0,15	0,25	500
WP30014	terminal blocks 1.5-18 x 12	Black	1,5	1,7	3,5	-	18	12	0,15	0,25	500
WP30016	terminal blocks 2.5-14 x 8	Blue	2,5	2,2	4,2	-	15	8	0,15	0,25	500
WP30017	terminal blocks 2.5-19 x 12	Blue	2,5	2,2	4,2	-	19	12	0,15	0,25	500
WP30019	terminal blocks 4.0-16 x 8	Grey	4	2,8	4,8	-	16	8	0,2	0,3	500
WP30020	terminal blocks 4.0-20 x 12	Grey	4	2,8	4,8	-	20	12	0,2	0,3	500
WP30022	terminal blocks 6.0-20 x 12	Yellow	6	3,5	6,3	-	20	12	0,2	0,3	100
WP30023	terminal blocks 6.0-26 x 18	Yellow	6	3,5	6,3	-	26	18	0,2	0,3	100
WP30024	terminal blocks 10-22 x 12	Red	10	4,5	7,6	-	22	12	0,2	0,4	100
WP30025	terminal blocks 100-28 x 18	Red	10	4,5	7,6	-	28	18	0,2	0,4	100
WP30026	terminal blocks 16-22 x 12	Blue	16	5,8	8,8	-	22	12	0,2	0,4	100
WP30027	terminal blocks 160-28 x 18	Blue	16	5,8	8,8	-	28	18	0,2	0,4	100
WP30028	terminal blocks 25-30 x 16	Yellow	25	7,3	11,2	-	30	16	0,2	0,4	50
WP30029	terminal blocks 250-36 x 22	Yellow	25	7,3	11,2	-	36	22	0,2	0,4	50
WP30030	terminal blocks 35-30 x 16	Red	35	8,3	12,7	-	30	16	0,2	0,4	50
WP30031	terminal blocks 350-39 x 25	Red	35	8,3	12,7	-	39	25	0,2	0,4	50
WP30032	terminal blocks 50-36 x 20	Blue	50	10,3	15	-	36	20	0,3	0,5	50
WP30033	terminal blocks 500-41 x 25	Blue	50	10,3	15	-	41	25	0,3	0,5	50

Terminals with sleeves and insulated collars

Series: WP

The double slot series is made of tin-plated electrolytic copper with the insulated part in polypropylene, resistant up to 105°C.

These terminals were designed for use in connections where a quick and safe connection is required. In fact, the current trend towards miniaturisation of electrical equipment makes these terminals particularly useful and economical.

The special large housing slot is easily able to hold the bulk created by two wires.

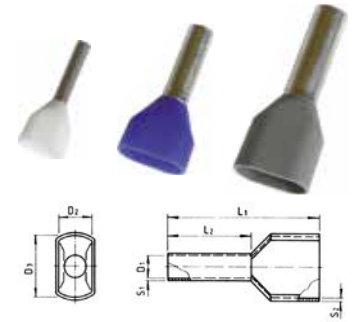

CODICE	DESCRIZIONE	COLORE	SEZIONE	D1	D2	D3	L1	L2	S1	S2	PZ.CONF.
			mm ²	mm	mm	mm	mm	mm	mm	mm	
WP90001	-	white	2,0 x 0,5	1,1,5	2,5	4,7	15,7	8,7	0,15	0,3	500
WP90002	-	grey	2,0 x 0,75	1,8	2,8	5,0	15,5	8,9	0,15	0,3	500
WP90003	-	red	2,0 x 1,0	2,3	3,2	5,5	15,8	8,0	0,15	0,3	500
WP90004	-	black	2,0 x 1,5	2,3	3,5	6,5	16,0	8,0	0,15	0,3	500
WP90005	-	blue	2,0 x 2,5	2,9	4,3	7,5	18,3	10,0	0,20	0,4	500
WP90006	-	grey	2,0 x 4,0	3,8	4,9	8,8	23,3	12,5	0,20	0,4	100
WP90007	-	yellow	2,0 x 6,0	-	-	-	-	12	-	-	100
WP90008	-	red	2,0 x 10	-	-	-	-	14	-	-	100

Terminals with uninsulated sleeves

Made of tin-plated electrolytic copper.



CODICE	DESCRIZIONE	SEZIONE	LUNGHEZZA	PZ.CONF.
WPN10508	uninsulated terminal block 0.5-8	0,5	8	1000
WPN10758	uninsulated terminal block 0.75-8	0,75	8	1000
WPN11010	uninsulated terminal block 1-10	1	10	1000
WPN11510	uninsulated terminal block 1.5-10	1,5	10	1000
WPN12510	uninsulated terminal block 2.5-10	2,5	10	1,000*
WPN14012	uninsulated terminal block 4.0-12	4	12	1000**
WPN16012	uninsulated terminal block 6.0-12	6	12	500
WPN11015	uninsulated terminal block 10-15	10	15	500
WPN11615	uninsulated terminal block 16-15	16	15	500
WPN12515	uninsulated terminal block 25-15	25	15	100

Nota1: * appropriate for use with Cabur CBC.2 terminal blocks

Nota2: ** appropriate for use with Cabur CBC.4 terminal blocks

Blank lined area for notes.

Industrial Marking System (extract from full catalogue)

The new printer SmartPrint Plus with thermal transfer technology is Cabur's answer to the many different needs in the world of industrial marking. Ideal for identifying terminal blocks, cables and electrical components. It is characterized by an attractive and functional design that makes immediate, simple and intuitive use and it is lighter and more manageable thanks to a new ultra-resistant ABS thermoplastic polymer shell.

Reliable, versatile, precise and fast SmartPrint Plus allows to create high resolution prints for excellent quality and long-lasting markings.

With SmartPrint Plus you can print up to 100 tags in 6 seconds, identify terminal blocks made by Cabur and other manufacturers, single cables or bundles, buttons, electrical components and carry out the complete marking of the outside panel. Ribbons are the longest on the market, with a highly competitive price. The installation of the MarKing Pro XT software and the SmartPrint Plus printer on WINDOWS systems starting from WIN7 up to WIN10 is quick and easy and in seconds the printer will be ready for use.

The Multi-Page printing function allows to manage the printer directly by the buttons onboard the machine and allows easier and more practical use without having a PC nearby; the new multi-plate function allows to launch all the prints from pc at once and manage them directly from the printer, making the printing process faster and easier.

Equipped with a display and two control keys, SmartPrint enables the printing of alphanumeric texts, logos and graphic symbols on numerous marking media:

- sleeve tags to identify wires
- adhesive cable marking labels
- tags for terminal blocks
- tags for push-buttons
- tags for contactors/PLCs;
- modular strips for electrical distribution panels
- panel identification tags.

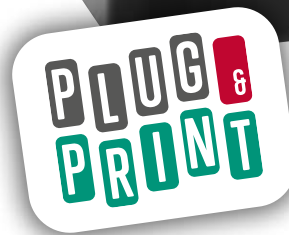

TECHNICAL DATA

Code	SMARTPRINTPLUS
Dimensions (DxLxH)	250 x 250 x 380 mm
Weight	9,5 kg
Display	LCD
Interface	USB 2.0
Resolution	300x600 dpi
Print Speed	19 mm/seconds
Windows support	Microsoft® Windows™ 7 o later
Power supply voltage	100-240Vac 50-60Hz
Current	1,5 A
Working temperature	+5°C +40°C
Print area	105 mm x 140 mm
Ribbon	high strength resin
Ribbon colours	Black, Blue, Red, Green, White



THE PACKAGE INCLUDES

- 1 SmartPrint Plus printer
- 1 USB cable
- 1 Power cable
- 1 Power supply
- 1 Ribbon code RSP300BK
- 1 MarKing Pro XT Software, complete with user manual in electronic format
- 1 Plate Kit made up of
 - 1 PLT06 support plate for cable tags code NUT12S/NUT18S;
 - 1 PLT01 support plate for FLAT series tags code NUT FL-TAP-TAV-TAM - TMM - SIM

Code: SMARTROLL - Marking: SMARTROLL

The SmartRoll thermal transfer printer is simple to use and guarantees rapid production of perfectly defined labels. Resistant, reliable and without the need for particular maintenance, SmartRoll is designed for high print volumes and is suited to any working environment. Precise in all details, it guarantees the lowest noise levels during use. Fitted with a display for controls and an acoustic signal, it is the ideal solution for continual and fast printing on:

- sleeve tags to identify wires
- adhesive cable-marking labels
- tags for contactors;
- **MarKing Pro XT** management software

SmartRoll is also equipped with a LAN / WLAN network port to be shared online and used with different computer



TECHNICAL DATA

Technology for	thermal transfer
Interface	USB 2.0
Resolution	300 dpi
Print Speed	Up to 152 mm/sec
Windows support	Microsoft® Windows™ 7 or later
Dimensions (DxLxH)	505 x 270 x 308 mm
Weight	approx. 15 Kg.
Power supply voltage	100 - 240 VAC
Working temperature	5-40°C
Ribbon	monochromatic resin based
Ribbon colours	Black, Red

THE PACKAGE INCLUDES:

- 1 SmartRoll printer
- 1 USB cable
- 1 Power cable
- 1 MarKing Pro XT Software, complete with user manual in electronic format
- 1 Ribbon code RSR300BK

Code: CABURJET - ID code: CABURJET

The CaburJet inkjet printer has a smaller size to reduce bulk and offers an innovative design, aimed at making it fast and easy to use, with no maintenance problems. It's the ideal solution for continuous, automatic, and fast printing of:

- sleeve tags to identify wires
- tags for terminal blocks;
- tags for push-buttons;
- tags for contactors;
- modular strips for electrical distribution panels
- panel identification tags.
- **MarKing Pro** management software

This is a highly innovative solution, created to meet multiple needs **in the industrial field**, at a competitive price.

The printer has an automatic integrated feeder (SEPARATOR), which accepts all of the above mentioned products - even mixed. It is also possible to print on individual stems by simply placing them at the bottom of the feeder like a normal sheet of paper.

The feeder can hold 50 cards for a total of 3,000 NUT12 series tags (tags for 12 mm long sleeves).

After just an hour of printing, 24,000 tags are ready for use. The material used (self-extinguishing polycarbonate) for production of the cards, together with the ink, means that the card can be used almost immediately after printing, and is indelible in accordance with CEI 16-7.



TECHNICAL DATA	
Print technology	monochromatic inkjet printing
Interface	USB 2.0
Resolution	360 Dpi
Ink	refillable bottles
Print Speed	24,000 tags per hour
Windows support	for PC systems with Windows 98 SP2 and later
Dimensions (LxWxH)	330 x 370 x 220 mm
Weight	approx. 12 Kg.
Electricity consumption	during printing, 24W max. with compressor on, 35W
Power supply voltage	115-230V

THE PACKAGE INCLUDES:	
1 CaburJet printer	
1 USB cable	
1 Power cable	
2 80 ml bottle of ink	
1 250 ml bottle of cleaner	
1 copy of MarKing Pro software; including a licence for 5 installations, and a digital user manual	



CNU/8/51 for HORIZONTAL and VERTICAL printing

- Marking tags suitable for marking all types of terminal blocks (screw-tightening and spring-clamp) in tables of 100 elements in packs of 500 tags
- In white polycarbonate with black printing, to be applied directly into position either before or after preparing the rail assembly.
- **Tag dimensions: 8 x 5.1 mm. Pitch on CBC.2 and HMM.2/GR.**
- **Mounting of single tag on all Cabur terminal blocks.**



CODE FOR TAGS WITH VERTICAL NUMBERS	CODE FOR TAGS WITH HORIZONTAL NUMBERS	DESCRIPTION	CHARACTER	QUANTITY PK.
NU0851S	NU0851S	TAGS BLANK	-	1500
NU0851001V	NU0851001	TAG.NO. 1 to 50	1 - 50	500
NU0851010V	NU0851010	TAG.NO. 10	10	500
NU0851011V	NU0851011	TAG. NO. 11	11	500
NU0851012V	NU0851012	TAG. NO. 12	12	500
NU0851013V	NU0851013	TAG. NO. 13	13	500
NU0851014V	NU0851014	TAG. NO. 14	14	500
NU0851015V	NU0851015	TAG. NO. 15	15	500
NU0851016V	NU0851016	TAG. NO. 16	16	500
NU0851017V	NU0851017	TAG. NO. 17	17	500
NU0851018V	NU0851018	TAG. NO. 18	18	500
NU0851019V	NU0851019	TAG. NO. 19	19	500
NU0851020V	NU0851020	TAG. NO. 20	20	500
NU085102AV	NU085102A	TAGS. MARKED 2A	2A	500
NU0851051V	NU0851051	TAGS from 51 to 100	51 - 100	500
NU08510L1V	NU08510L1	TAGS. MARKED L1	L1	500
NU08510L2V	NU08510L2	TAGS. MARKED L2	L2	500
NU08510L3V	NU08510L3	TAGS. MARKED L3	L3	500
NU08510NIV	NU08510NI	TAGS. MARKED NI	NI	500
NU08510PEV	NU08510PE	TAGS. MARKED PE	PE	500
NU08510R1V	NU08510R1	TAGS. MARKED R1	R1	500
NU08510S1V	NU08510S1	TAGS. MARKED S1	S1	500
NU08510S2V	NU08510S2	TAGS. MARKED S2	S2	500
NU08510S3V	NU08510S3	TAGS. MARKED S3	S3	500
NU08510U1V	NU08510U1	TAGS. MARKED U1	U1	500
NU08510U2V	NU08510U2	TAGS. MARKED U2	U2	500
NU08510V	NU08510	TAGS NO. 0	0	500
NU08510V1V	NU08510V1	TAGS. MARKED V1	V1	500
NU08510V2V	NU08510V2	TAGS. MARKED V2	V2	500
NU08510W1V	NU08510W1	TAGS. MARKED W1	W1	500
NU08510W2V	NU08510W2	TAGS. MARKED W2	W2	500
NU0851101V	NU0851101	TAGS. from 101 to 150	101 - 105	500
NU085110V	NU085110	TAGS. MARKED =	=	500
NU085111V	NU085111	TAGS. MARKED +	+	500
NU085112V	NU085112	TAGS. MARKED -	-	500
NU085114V	NU085114	TAGS EARTH	⊕	500
NU0851151V	NU0851151	TAGS from 151 to 200	151 - 200	500
NU085115V	NU085115	TAG EARTH CIRCLE	⊕	500
NU08511V	NU08511	TAGS. NO. 1	1	500
NU0851201V	NU0851201	TAGS from 201 to 250	201 - 250	500
NU0851251V	NU0851251	TAGS from 251 to 300	251 - 300	500
NU08512V	NU08512	TAGS. NO. 2	2	500
NU0851301V	NU0851301	TAGS from 301 to 350	301 - 350	500
NU0851351V	NU0851351	TAGS from 351 to 400	351 - 400	500
NU08513V	NU08513	TAGS. NO. 3	3	500
NU0851401V	NU0851401	TAGS from 401 to 450	401 - 450	500
NU0851451V	NU0851451	TAGS from 451 to 500	451 - 500	500
NU08514V	NU08514	TAGS. NO 4	4	500
NU0851501V	NU0851501	TAGS from 501 to 550	501 - 550	500

Writing type

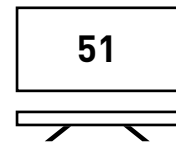

HORIZONTAL

Writing type

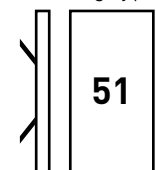

VERTICAL

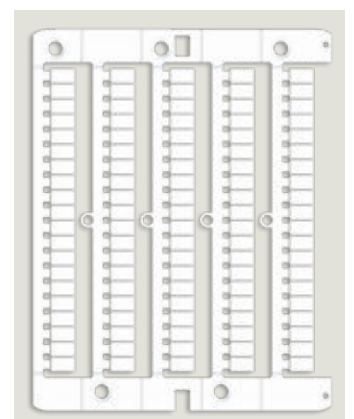

CNU/8/51 for HORIZONTAL and VERTICAL printing

- Marking tags suitable for marking all types of terminal blocks (screw-tightening and spring-clamp) in tables of 100 elements in packs of 500 tags
- In white polycarbonate with black printing, to be applied directly into position either before or after preparing the rail assembly.
- **Tag dimensions: 8 x 5.1 mm. Pitch on CBC.2 and HMM.2/GR.**
- **Mounting of single tag on all Cabur terminal blocks.**



CODE FOR TAGS WITH VERTICAL NUMBERS	CODE FOR TAGS WITH HORIZONTAL NUMBERS	DESCRIPTION	CHARACTER	QUANTITY PK.
NU0851510V	NU0851510	TAGS from 1 to 10	1 - 10	500
NU0851520V	NU0851520	TAGS from 11 to 20	11 - 20	500
NU0851530V	NU0851530	TAGS from 21 to 30	21 - 30	500
NU0851540V	NU0851540	TAGS from 31 to 40	31 - 40	500
NU0851550V	NU0851550	TAGS from 41 to 50	41 - 50	500
NU0851551V	NU0851551	TAGS from 551 to 600	551 - 600	500
NU0851560V	NU0851560	TAGS from 51 to 60	51 - 60	500
NU0851570V	NU0851570	TAGS from 61 to 70	61 - 70	500
NU0851580V	NU0851580	TAGS from 71 to 80	71 - 80	500
NU0851590V	NU0851590	TAGS from 81 to 90	81 - 90	500
NU08515V	NU08515	TAGS. NO 5	5	500
NU0851600V	NU0851600	TAGS from 91 to 100	91 - 100	500
NU0851601V	NU0851601	TAGS from 601 to 650	601 - 650	500
NU0851651V	NU0851651	TAGS from 651 to 700	651 - 700	500
NU08516V	NU08516	TAGS. NO. 6	6	500
NU0851701V	NU0851701	TAGS from 701 to 750	701 - 750	500
NU0851751V	NU0851751	TAGS from 751 to 800	751 - 800	500
NU08517V	NU08517	TAGS. NO. 7	7	500
NU0851801V	NU0851801	TAGS from 801 to 850	801 - 850	500
NU0851851V	NU0851851	TAGS from 851 to 900	851 - 900	500
NU08518V	NU08518	TAGS. NO. 8	8	500
NU0851901V	NU0851901	TAGS from 901 to 950	901 - 950	500
NU0851951V	NU0851951	TAGS from 951 to 1,000	951 - 000	500
NU08519V	NU08519	TAGS. NO. 9	9	500
NU0851AV	NU0851A	TAGS A	A	500
NU0851BV	NU0851B	TAGS B	B	500
NU0851CV	NU0851C	TAGS C	C	500
NU0851DV	NU0851D	TAGS D	D	500
NU0851EV	NU0851E	TAGS E	E	500
NU0851FV	NU0851F	TAGS F	F	500
NU0851GV	NU0851G	TAGS G	G	500
NU0851HV	NU0851H	TAGS H	H	500
NU0851IV	NU0851I	TAGS I	I	500
NU0851JV	NU0851J	TAGS J	J	500
NU0851KV	NU0851K	TAGS K	K	500
NU0851LV	NU0851L	TAGS L	L	500
NU0851MV	NU0851M	TAGS M	M	500
NU0851NV	NU0851N	TAGS N	N	500
NU0851OV	NU0851O	TAGS O	O	500
NU0851PV	NU0851P	TAGS P	P	500
NU0851QV	NU0851Q	TAGS Q	Q	500
NU0851RV	NU0851R	TAGS R	R	500
NU0851SV	NU0851S	TAGS S	S	500
NU0851TV	NU0851T	TAGS T	T	500
NU0851UV	NU0851U	TAGS U	U	500
NU0851VW	NU0851V	TAGS V	V	500
NU0851WV	NU0851W	TAGS W	W	500
NU0851XV	NU0851X	TAGS X	X	500
NU0851YV	NU0851Y	TAGS Y	Y	500
NU0851ZV	NU0851Z	TAGS Z	Z	500

Writing type

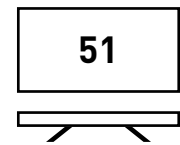

HORIZONTAL

Writing type

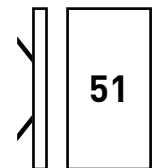

VERTICAL

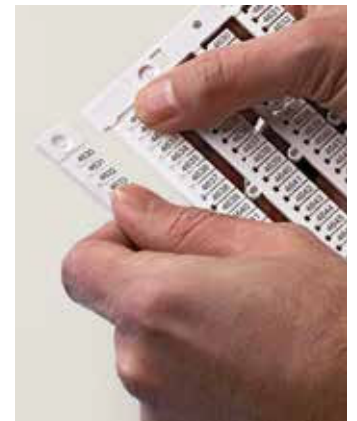

Mounting on Cabur terminal blocks.

Special numbering for terminal block marking

Cabur can supply, on request, special marking tags with numbers, letters, symbols and customised logos in packs of 500 tags, printed using the CaburJet System.

Request special marking by specifying the following on the order:

- A** - Item code, selected from those found in the table (e.g. NU0851SP)
- B** - Number of tags ordered (min. 500 pcs. / 1 pk.)
- C** - Writing type (horizontal or vertical)
- D** - Content (text, numbers, symbols) to be printed on the tags (e.g. A1B)

To optimise the service, as an alternative or in addition to that required at points c) and d), we recommend sending Cabur a MarKing Pro file created with the specific requirements of the order.

For example, by ordering:

Code: NU0851SP
 Quantity: 1000
 Writing type: horizontal
 Content: ABC

You will receive 2 packs of 500 tags each of CNU/8/51, personalised as requested.

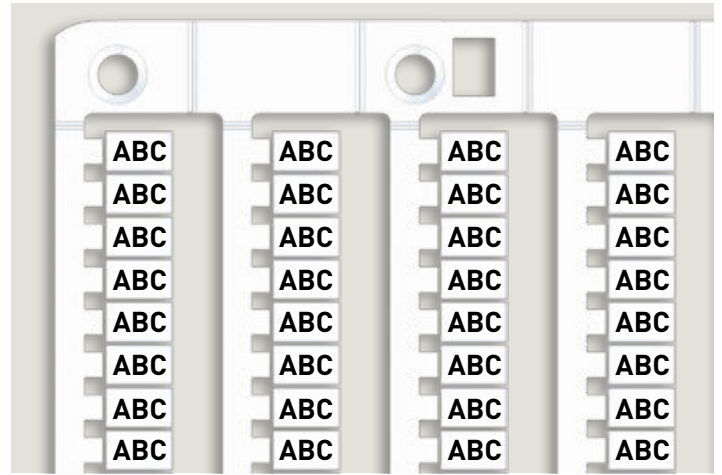

NU0800SP-NU0851SP-NU0861SP

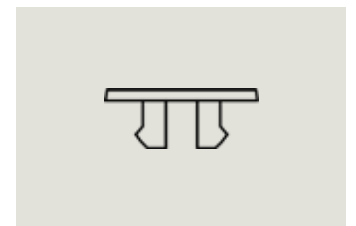

NU1051SP-NU1061SP-NU1055SP-NU1065SP

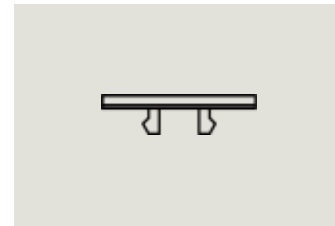

SH004SP

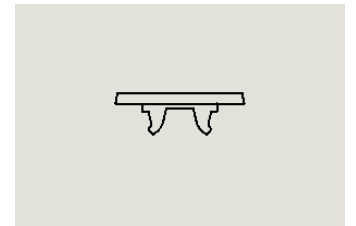

NUWDU50SP

SPECIAL NUMBERING		
CODE	ID CODE	DESCRIPTION
NU0800SP	NU0800SP	CNU/8/00 - special marking
NU0851SP	NU0851SP	CNU/8/51 - special marking
NU0861SP	NU0861SP	CNU/8/61 - special marking
NU1051SP	NU1051SP	CNU/10/51 - special marking
NU1061SP	NU1061SP	CNU/10/61 - special marking
SH004SP	SH004SP	SHZ.1 - special marking
SH004S	SH2.1	Blank tag spring-clamp terminal blocks sect 1.5 mm
SN008	SNZ/4/00	Blank strips
SN004SP	SNZ/4/SP	SN004SP - special numbering
NUWDU50SP	NUWDU50SP	NUWDU50 - special numbering
NUWDK50SP	NUWDK50SP	NUWDK50 - special numbering
NUPUTUK50SP	NUPUTUK50SP	NUPUTUK50 - special numbering
NUL1061SP	NUL1061	NUL1061 - special numbering
NU1055SP	NU1055SP	CNU/10/55 - special numbering
NU1065SP	NU1065SP	CNU/10/65 - special numbering
NUWG051SP	NUWG051SP	NUWG051SP - special numbering

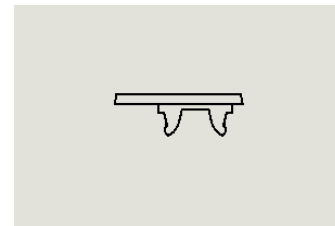

NUWDK50SP



NUPUTUK50S

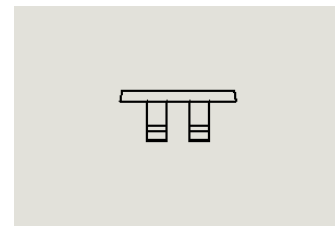

NUL1061SP

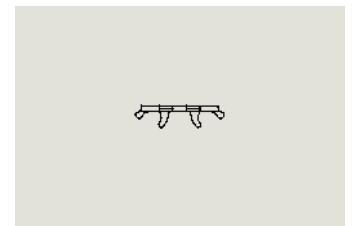

NUWG051SP

N.B. please contact our sales office for information about availability

Special numbering for wire marking

Cabur can supply, on request, special marking tags for wires, with numbers, letters, symbols and customised logos in packs of 500 tags, printed using the CaburJet System.

Request special numberings for wire marking, by specifying the following on the order:

- A** - Item code, selected from those found in the table (e.g. NUT15SP)
- B** - Number of tags ordered (min. 500 pcs. / 1 pk.)
- C** - Content (text, numbers, symbols) to be printed on the tags (e.g. A1B)

To optimise the service, as an alternative to or in addition to that required at point c), we recommend sending Cabur a MarKing Pro file created with the specific requirements of the order.

For example, by ordering:

Code: NUT15SP
 Quantity: 1500
 Content: ABC

An order will be placed for 3 packs of 500 tabs each of NUT15, customised as requested.

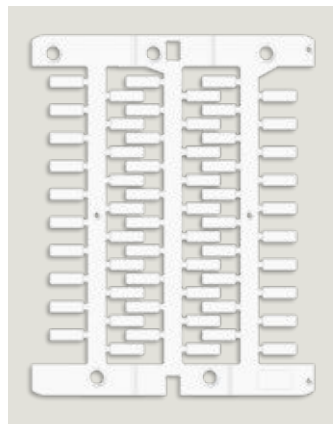
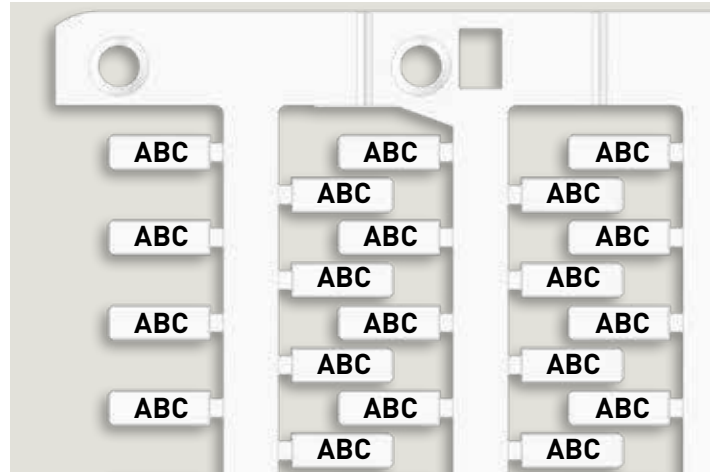

Mounting on Cabur terminal blocks

Writing type



HORIZONTAL

SPECIAL NUMBERING		
CODE	ID CODE	DESCRIPTION
NUT12SP	NUT12SP	NUT12SP - special numbering
NUT12YSP	NUT12YSP	NUT12YSP - special numbering
NUT15SP	NUT15SP	NUT15SP - special numbering
NUT15YSP	NUT15YSP	NUT15YSP - special numbering
NUT18SP	NUT18SP	NUT18SP - special numbering
NUT18YSP	NUT18YSP	NUT18YSP - special numbering
NUT23SP	NUT23SP	NUT23SP - special numbering
NUT23YSP	NUT23YSP	NUT23YSP - special numbering

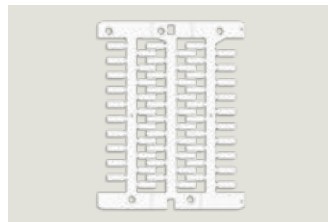

TAG CARD L. 12 mm



TAG CARD L. 15 mm

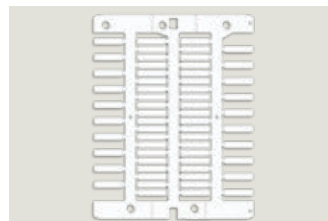

TAG CARD L. 18 mm



TAG CARD L. 23 mm

A

CODE	TYPE	QTY. per pk.	PAGE
AC100	ACB.70/BB	12	p. 82
AC400	ACB.120/BB	12	p. 82
AC700	ACB.185/BB	12	p. 82
AF201	AFO/PT	50	p. 152
AF400	AFO.2/2+2	100	p. 123
AF500	AFO.2/1+1	100	p. 123
BC100	BCA.70/BB	1	p. 83
BC400	BCA.120/BB	1	p. 83
BP100	BPL.4	60	p. 131
BP200	BPL/R	100	p. 131
BP300	BPL.4/PS	60	p. 132
BT003	BT/3	25	p. 153
BT005	BTU	25	p. 153
BT006	BT/2	25	p. 153
BT007	BTO	25	p. 153

B

CODE	TYPE	QTY. per pk.	PAGE
CAMUT010	CAMUT.12/10	10	p. 147
CAMUT02	CAMUT.12/02	10	p. 147
CAMUT04	CAMUT.12/04	10	p. 147
CAMUT06	CAMUT.12/06	10	p. 147
CAMUT16	CAMUT.12/16	10	p. 147
CAMUT25	CAMUT.12/25	10	p. 147
CAMUT35	CAMUT.12/35	10	p. 147
CB009	CBD/SH	10	p. 172
CB061GR	CBC.2-10/PT/GR	50	p. 152
CB110	CBD.2	120	p. 67
CB111	CB2/PT	50	p. 152
CB161GR	CBC.16/PT/GR	25	p. 152
CB240	CBD.4	100	p. 67
CB241	CB4/6/PT	25	p. 152
CB340	CBD.6	100	p. 67
CB351GR	CBC.35/PT/GR	25	p. 152
CB431	CB10/PT	25	p. 152
CB440	CBD.10	100	p. 68
CB510	CBD.16	50	p. 68
CB511	CB16/PT	25	p. 152
CB610	CBD.35	75	p. 68
CB611	CB35/PT	25	p. 152
CB710	CBD.50	50	p. 69
CB710GR	CBD.50/GR	50	p. 69
CB711	CB50/PT	10	p. 152
CB810	CBD.70	40	p. 69
CB810GR	CBD.70/GR	40	p. 69
CB811	CB70/PT	10	p. 152
CBC02GR	CBC.2/GR	120	p. 55
CBC04GR	CBC.4/GR	100	p. 55
CBC06GR	CBC.6/GR	100	p. 55
CBC10GR	CBC.10/GR	100	p. 56
CBC16GR	CBC.16/GR	50	p. 56
CBC35GR	CBC.35/GR	50	p. 56
CBF04	CBF.4	50	p. 97
CBF04GR	CBF.4/GR	50	p. 97
CBF04I	CBF.4 [Ex]i	50	p. 97

C

CODE	TYPE	QTY. per pk.	PAGE
CBX09	CBD/SH	10	p. 172
CBX061GR	CBC.2-10/PT/GR	50	p. 152
CBX110	CBD.2	120	p. 67
CBX111	CB2/PT	50	p. 152
CBX161GR	CBC.16/PT/GR	25	p. 152
CBX240	CBD.4	100	p. 67
CBX241	CB4/6/PT	25	p. 152
CBX340	CBD.6	100	p. 67
CBX351GR	CBC.35/PT/GR	25	p. 152
CBX431	CB10/PT	25	p. 152
CBX440	CBD.10	100	p. 68
CBX510	CBD.16	50	p. 68
CBX511	CB16/PT	25	p. 152
CBX610	CBD.35	75	p. 68
CBX611	CB35/PT	25	p. 152
CBX710	CBD.50	50	p. 69
CBX710GR	CBD.50/GR	50	p. 69
CBX711	CB50/PT	10	p. 152
CBX810	CBD.70	40	p. 69
CBX810GR	CBD.70/GR	40	p. 69
CBX811	CB70/PT	10	p. 152
CBC02GR	CBC.2/GR	120	p. 55
CBC04GR	CBC.4/GR	100	p. 55
CBC06GR	CBC.6/GR	100	p. 55
CBC10GR	CBC.10/GR	100	p. 56
CBC16GR	CBC.16/GR	50	p. 56
CBC35GR	CBC.35/GR	50	p. 56
CBF04	CBF.4	50	p. 97
CBF04GR	CBF.4/GR	50	p. 97
CBF04I	CBF.4 [Ex]i	50	p. 97

CODE	TYPE	QTY. per pk.	PAGE
CBF423GR	CBF.4/C23/GR	50	p. 103
CBF448GR	CBF.4/C48/GR	50	p. 103
CBI02	CBC.2 [EX]i	120	p. 55
CBI04	CBC.4 [EX]i	100	p. 55
CBI06	CBC.6 [EX]i	100	p. 55
CBI061	CBC.2-10/PT[Ex]i	50	p. 152
CBI10	CBC.10 [EX]i	100	p. 56
CBI16	CBC.16 [EX]i	50	p. 56
CBI161	CBC.16/PT[Ex]i	25	p. 152
CBI35	CBC.35 [EX]i	50	p. 56
CBI351	CBC.35/PT[Ex]i	25	p. 152
CBS02	CBS.2	100	p. 104
CBS02GR	CBS.2/GR	100	p. 104
CBS02I	CBS.2 [Ex] i	100	p. 104
CBS04	CBS.4	80	p. 104
CBS04GR	CBS.4/GR	80	p. 104
CBS04I	CBS.4 [Ex]i	80	p. 104
CBX12	CBD.2 [EX]i	120	p. 67
CBX13	CB2/PT [Ex]i	50	p. 152
CBX24	CBD.4 [EX]i	100	p. 67
CBX25	CB4/6/PT [Ex]i	25	p. 152
CBX34	CBD.6 [EX]i	100	p. 67
CBX44	CB10/PT [Ex]i	25	p. 152
CBX45	CBD.10 [EX]i	100	p. 68
CBX52	CBD.16 [EX]i	50	p. 68
CBX53	CB16/PT [Ex]i	25	p. 152
CBX62	CBD.35 [EX]i	75	p. 68
CBX63	CB35/PT [Ex]i	25	p. 152
CBX72	CBD.50 [EX]i	50	p. 69
CBX73	CB50/PT [Ex]i	10	p. 152
CBX82	CBD.70 [EX]i	40	p. 69
CBX83	CB70/PT [Ex]i	10	p. 152
CCH02	CCH/2.5-4	1	p. 179
CCH06	CCH/6	1	p. 179
CCV03	CCV/2.5	1	p. 179
CCV04	CCV/4	1	p. 179
CCV05	CCV/5	1	p. 179
CE110	CBE.2	70	p. 86
CF100	CF.12/1+1	50	p. 133
CF200	CF.12/2+2	25	p. 133
CF900	CF.12/CPT	40	p. 133
CI110	CBR.2 [EX]i	75	p. 57
CONT206	CONT/2/06	20	p. 145
CONT216	CONT/2/16	20	p. 145
CONT225	CONT/2/25	10	p. 145
CONT235	CONT/2/35	5	p. 145
CONT306	CONT/3/6	10	p. 145
CONT316	CONT/3/16	5	p. 145
CONT606	CONT/6/6	5	p. 145
CONT616	CONT/6/16	5	p. 145
CONTC01	CONT/1,5	10	p. 146
CONTC02	CONT/2,5	10	p. 146

CODE	TYPE	QTY. per pk.	PAGE
CONTC04	CONT/4	10	p. 146
CONTC06	CONT/6	10	p. 146
CONTC10	CONT/10	5	p. 146
CONTC16	CONT/16	5	p. 146
CONTC25	CONT/25	5	p. 146
CPF05	CPF/5	20	p. 171
CPFE02	CPFE/2	20	p. 171
CPFE04	CPFE/4	20	p. 171
CR110	CBR.2	75	p. 57
CR110GR	CBR.2/GR	75	p. 57
CR111	CBR/PT	25	p. 152
CV100	CVF.4	100	p. 124
CV100GR	CVF.4/GR	100	p. 124
CV101	CVF/PT	25	p. 152
CV101GR	CVF/PT/GR	25	p. 152
CV201	CVF/PT [Ex]i	25	p. 152
DA100	DSFA.4	100	p. 101
DA100GR	DSFA.4/GR	100	p. 101
DA200	DSF.4	80	p. 100
DA200GR	DSF.4/GR	80	p. 100
DB100	DBC.2	120	p. 90
DB100GR	DBC.2/GR	120	p. 90
DB101	DBC/PT	25	p. 152
DB117	DBC.2/CI	120	p. 90
DB117GR	DBC.2/CI/GR	120	p. 90
DB200	DBC.2 [EX]i	120	p. 90
DB201	DBC/PT[Ex]i	25	p. 152
DB400GR	DBC.4/GR	100	p. 91
DB417GR	DBC.4/CI/GR	100	p. 91
DB500	DBC.4 [Ex]i	100	p. 91
DB517	DBC.4/CI [Ex]i	100	p. 91
DC005	SDC/5	25	p. 169
DC006	SDC/6	25	p. 169
DC05P	SDC/5P	25	p. 169
DC06P	SDC/6P	25	p. 169
DD001	SDD/1	50	p. 170
DD002	SDD/2	50	p. 170
DD005	SDD/5	25	p. 169
DD006	SDD/6	25	p. 169
DD501	SD5/PT	25	p. 169
DD601	SD6/PT	25	p. 169
DF300	DFM/300	50	p. 175
DF400	DFM/400	50	p. 175
DF500	DFM/500	50	p. 175
DF600	DFM/600	50	p. 175
DF700	DFM/700	50	p. 175
DF800	DFM/800	50	p. 175
DF900	DFM/900	50	p. 175
DFE01R	DFE.1+1/R	20	p. 174
DFE02R	DFE.1+2/R	20	p. 174
DFE03R	DFE.2+2/R	20	p. 174
DFE04R	DFE.2P/R	20	p. 174

D

CODE	TYPE	QTY. per pk.	PAGE
DFP2R	DFP/2/R	50	p. 174
DH004	SDH/4	25	p. 169
DH005	SDH/5	25	p. 169
DH006	SDH/6	25	p. 169
DH007	SDH/7	25	p. 169
DH01R	DFH/1/R	25	p. 174
DH02R	DFH/2/R	25	p. 174
DH03R	DFH/3/R	25	p. 174
DH04R	DFH/4/R	25	p. 174
DH401	SH4/PT	25	p. 169
DH501	SH5/PT	25	p. 169
DH601	SH6/PT	25	p. 169
DH701	SH7/PT	25	p. 169
DS100	DAS.4	120	p. 92
DS100GR	DAS.4/GR	120	p. 92
DS101	DAS/PT	25	p. 152
DS107	DAS/VCI	25	p. 172
DS108	DAS/VCE	25	p. 172
DS110	DAS.4/SS	20	p. 93
DS110GR	DAS.4/SS/GR	20	p. 93
DS111	DAS.4/A	20	p. 118
DS111GR	DAS.4/A/GR	20	p. 118
DS112	DAS.4/B	20	p. 118
DS112GR	DAS.4/B/GR	20	p. 118
DS113	DAS.4/C	20	p. 119
DS113GR	DAS.4/C/GR	20	p. 119
DS114	DAS.4/D	20	p. 119
DS114GR	DAS.4/D/GR	20	p. 119
DS115	DAS.4/E	20	p. 120
DS115GR	DAS.4/E/GR	20	p. 120
DS117	DAS.4/CI	120	p. 92
DS117GR	DAS.4/CI/GR	120	p. 92
DS119	DAS.4/I	20	p. 120
DS119GR	DAS.4/I/GR	20	p. 120
DS120	DAS.4/DD	20	p. 121
DS120GR	DAS.4/DD/GR	20	p. 121
DS128	DAS.4/T	20	p. 122
DS128GR	DAS.4/T/GR	20	p. 122
DS129	DAS.4/U	20	p. 122
DS129GR	DAS.4/U/GR	20	p. 122
DS130	DAS.4/L	20	p. 121
DS130GR	DAS.4/L/GR	20	p. 121
DS200	DAS.4 (EX)I	120	p. 92
DS201	DAS/PT (Ex)I	25	p. 152
DS217	DAS.4/CI (EX)I	120	p. 92
DS301	DSS/PT	25	p. 152
DS301GR	DSS/PT/GR	25	p. 152
DS400	DSS.4	100	p. 93
DS400	DSS.4	100	p. 93
DS400GR	DSS.4/GR	100	p. 93
DS400GR	DSS.4/GR	100	p. 93
DS401GR	DFS.4/PT/GR	25	p. 152

CODE	TYPE	QTY. per pk.	PAGE
DSD005	DAS.4/D5	20	p. 114
DSD005GR	DAS.4/D5/GR	20	p. 114
DSD012	DAS.4/D12	20	p. 114
DSD012GR	DAS.4/D12/GR	20	p. 114
DSD024	DAS.4/D24	20	p. 115
DSD024GR	DAS.4/D24/GR	20	p. 115
DSD060	DAS.4/D60	20	p. 115
DSD060GR	DAS.4/D60/GR	20	p. 115
DSV024	DAS.4/V24	20	p. 116
DSV024GR	DAS.4/V24/GR	20	p. 116
DSV048	DAS.4/V48	20	p. 116
DSV048GR	DAS.4/V48/GR	20	p. 116
DSV120	DAS.4/V120	20	p. 117
DSV120GR	DAS.4/V120/GR	20	p. 117
DSV230	DAS.4/V230	20	p. 117
DSV230GR	DAS.4/V230/GR	20	p. 117
DU01R	DFU/1/R	50	p. 174
DU02R	DFU/2/R	50	p. 174
DU03R	DFU/3/R	50	p. 174
DU04R	DFU/4/R	50	p. 174
DU05R	DFU/5/R	50	p. 174
DU06R	DFU/6/R	50	p. 174
DU07R	DFU/7/R	50	p. 174
EFB0202B	EFB.2/2/B	20	p. 165
EFB0202R	EFB.2/2/R	20	p. 165
EFB0203B	EFB.2/3/B	20	p. 165
EFB0203R	EFB.2/3/R	20	p. 165
EFB0205B	EFB.2/5/B	10	p. 165
EFB0205R	EFB.2/5/R	10	p. 165
EFB0210B	EFB.2/10/B	5	p. 165
EFB0210R	EFB.2/10/R	5	p. 165
EFB0402B	EFB.4/2/B	20	p. 165
EFB0402R	EFB.4/2/R	20	p. 165
EFB0403B	EFB.4/3/B	20	p. 165
EFB0403R	EFB.4/3/R	20	p. 165
EFB0405B	EFB.4/5/B	10	p. 165
EFB0405R	EFB.4/5/R	10	p. 165
EFB0410B	EFB.4/10/B	5	p. 165
EFB0410R	EFB.4/10/R	5	p. 165
EFC100BL	EFC.1/BL		p. 13
EFC100GR	EFC.1/GR		p. 13
EFC110BL	EFC.1/1+2/BL		p. 13
EFC110GR	EFC.1/1+2/GR		p. 13
EFC120BL	EFC.1/2+2/BL		p. 13
EFC120GR	EFC.1/2+2/GR		p. 13
EFC200BL	EFC.2/BL	160	p. 15
EFC200GR	EFC.2/GR	160	p. 15
EFC201BL	EFC.2/PT/BL	25	p. 152
EFC201GR	EFC.2/PT/GR	25	p. 152
EFC210BL	EFC.2/1+2/BL	120	p. 15
EFC210GR	EFC.2/1+2/GR	120	p. 15
EFC211BL	EFC.2/1+2/PT/BL	25	p. 152

CODE	TYPE	QTY. per pk.	PAGE
EFC211GR	EFC.2/1+2/PT/GR	25	p. 152
EFC220BL	EFC.2/2+2/BL	90	p. 15
EFC220GR	EFC.2/2+2/GR	90	p. 15
EFC221BL	EFC.2/2+2/PT/BL	25	p. 152
EFC221GR	EFC.2/2+2/PT/GR	25	p. 152
EFC400BL	EFC.4/BL	120	p. 17
EFC400GR	EFC.4/GR	120	p. 17
EFC401BL	EFC.4/PT/BL	25	p. 152
EFC401GR	EFC.4/PT/GR	25	p. 152
EFC410BL	EFC.4/1+2/BL	110	p. 17
EFC410GR	EFC.4/1+2/GR	110	p. 17
EFC411BL	EFC.4/1+2/PT/BL	25	p. 152
EFC411GR	EFC.4/1+2/PT/GR	25	p. 152
EFC420BL	EFC.4/2+2/BL	90	p. 17
EFC420GR	EFC.4/2+2/GR	90	p. 17
EFC421BL	EFC.4/2+2/PT/BL	25	p. 152
EFC421GR	EFC.4/2+2/PT/GR	25	p. 152
EFC600BL	EFC.6/BL		p. 19
EFC600GR	EFC.6/GR		p. 19
EFC610BL	EFC.6/1+2/BL		p. 19
EFC610GR	EFC.6/1+2/GR		p. 19
EFCE100	EFCE.1		p. 14
EFCE110	EFCE.1/1+2		p. 14
EFCE120	EFCE.1/2+2		p. 14
EFCE200	EFCE.2	80	p. 16
EFCE210	EFCE.2/1+2	50	p. 16
EFCE220	EFCE.2/2+2	60	p. 16
EFCE400	EFCE.4	70	p. 18
EFCE410	EFCE.4/1+2	60	p. 18
EFCE420	EFCE.4/2+2	90	p. 18
EFCE600	EFCE.6		p. 20
EFCE610	EFCE.6/1+2		p. 20
EFD100BL	EFD.1/BL		p. 21
EFD100GR	EFD.1/GR		p. 21
EFD110BL	EFD.1/CI/BL		p. 21
EFD110GR	EFD.1/CI/GR		p. 21
EFD120GR	EFD.1/E/GR		p. 21
EFD200BL	EFD.2/BL	130	p. 22
EFD200GR	EFD.2/GR	130	p. 22
EFD201BL	EFD.2/PT/BL	25	p. 152
EFD201GR	EFD.2/PT/GR	25	p. 152
EFD210BL	EFD.2/CI/BL	30	p. 22
EFD210GR	EFD.2/CI/GR	30	p. 22
EFD220GR	EFD.2/E/GR	30	p. 22
EFD400BL	EFD.4/BL	100	p. 23
EFD400GR	EFD.4/GR	100	p. 23
EFD401BL	EFD.4/PT/BL	25	p. 152
EFD401GR	EFD.4/PT/GR	25	p. 152
EFD410BL	EFD.4/CI/BL	40	p. 23
EFD410GR	EFD.4/CI/GR	40	p. 23
EFD420GR	EFD.4/E/GR	40	p. 23
EFDE100	EFDE.1		p. 24

CODE	TYPE	QTY. per pk.	PAGE
EFDE200	EFDE.2	30	p. 24
EFDE400	EFDE.4	40	p. 24
EFDS200GR	EFDS.2/GR	45	p. 27
EFDS201GR	EFDS.2/PT/GR	25	p. 152
EFDS202GR	CPFE.2 + EFDS.2/GR	30	p. 29
EFDS210GR	EFDS.2/1S/GR	45	p. 27
EFDS212GR	CPFE.2 + EFDS.2/1S/GR	30	p. 29
EFDS220GR	EFDS.2/P/GR	45	p. 27
EFF400BL	EFF.4/BL	35	p. 28
EFF400GR	EFF.4/GR	35	p. 28
EFF423GR	EFF.4/C230/GR	35	p. 28
EFF448GR	EFF.4/C48/GR	35	p. 28
EFS200BL	EFS.2/BL	75	p. 25
EFS200GR	EFS.2/GR	75	p. 25
EFS202GR	CPFE.2 + EFS.2/GR	35	p. 29
EFS400BL	EFS.4/BL	70	p. 25
EFS400GR	EFS.4/GR	70	p. 25
EFS402GR	CPFE.4 + EFS.4/GR	35	p. 29
EFT200BL	EFT.2/BL	100	p. 26
EFT200GR	EFT.2/GR	100	p. 26
EFT201BL	EFT.2/PT/BL	25	p. 152
EFT201GR	EFT.2/PT/GR	25	p. 152
EFT250GR	EFT.2/S/GR	100	p. 26
EFT251GR	EFT.2/S/PT/GR	25	p. 152
EFTE200	EFTE.2	35	p. 26
FC102	SFC/CO	70	p. 172
FD100	FDP.2	70	p. 124
FD100GR	FDP.2/GR	70	p. 124
FD101	FDP/PT	25	p. 152
FD101GR	FDP/PT/GR	25	p. 152
FF100	FFS.4	120	p. 94
FF100GR	FFS.4/GR	120	p. 94
FF101	FFS/PT	25	p. 152
FF101GR	FFS/PT/GR	25	p. 152
FJ402	FJ402	80	p. 148
FJ403	FJ403	60	p. 148
FL201	FL201	100	p. 173
FL202	FL202	100	p. 173
FN001ST	F5/100 mA	100	p. 173
FN002ST	F5/200 mA	100	p. 173
FN003ST	F5/315 mA	100	p. 173
FN004ST	F5/500 mA	100	p. 173
FN005ST	F5/630 mA	100	p. 173
FN006ST	F5/1 A	100	p. 173
FN007ST	F5/1.6 A	100	p. 173
FN008ST	F5/2 A	100	p. 173
FN009ST	F5/2.5 A	100	p. 173
FN010ST	F5/3.15 A	100	p. 173
FN011ST	F5/4 A	100	p. 173
FN012ST	F5/5 A	100	p. 173
FN013ST	F5/6.3 A	100	p. 173
FN014ST	F5/8 A	100	p. 173

CODE	TYPE	QTY. per pk.	PAGE
FN015ST	F5/10 A	100	p. 173
FN016ST	F5/12 A	100	p. 173
FP100	FPC.10	70	p. 102
FP100	FPC.10	70	p. 102
FP200	FPL.10/L	70	p. 102
FP300	FPL.10/C	70	p. 102
FP923	FPL.10/C230	70	p. 103
FP948	FPL.10/C48	70	p. 103
FV100	FVS.4	120	p. 94
FV100GR	FVS.4/GR	120	p. 94
FV101	FVS/PT	25	p. 152
FV101GR	FVS/PT/GR	25	p. 152
FV107	FVS/VCI	25	p. 172
FV108	FVS/VCE	25	p. 172
G			
GA100	GPA.95	10	p. 59
GA100GR	GPA.95/GR	10	p. 59
GA110	GPA.95 [EX]I	10	p. 59
GA200	GPA.150	8	p. 60
GA200GR	GPA.150/GR	8	p. 60
GA300	GPA.240	4	p. 61
GA300GR	GPA.240/GR	4	p. 61
GA400	GPA.70	25	p. 58
GA400GR	GPA.70/GR	25	p. 58
GA410	GPA.70 [EX]I	25	p. 58
GF100	GPA.95/FIX	10	p. 59
GF100GR	GPA.95/FIX/GR	10	p. 59
GF200	GPA.150/FIX	8	p. 60
GF200GR	GPA.150/FIX/GR	8	p. 60
GF300	GPA.240/FIX	4	p. 61
GF300GR	GPA.240/FIX/GR	4	p. 61
GF400	GPA.70/FIX	25	p. 58
GF400GR	GPA.70/FIX/GR	25	p. 58
GP100	GPM.95/BB	10	p. 71
GP100GR	GPM.95/BB/GR	10	p. 71
GP110	GPM.95/BB/FIX	10	p. 71
GP110GR	GPM.95/BB/FIX/GR	10	p. 71
GP120	GPM.95/O/BB	10	p. 80
GP125	GPM.95/C/BB	10	p. 80
GP130	GPM.95/O/BB/FIX	10	p. 80
GP135	GPM.95/C/BB/FIX	10	p. 80
GP200	GPM.95/BC	10	p. 74
GP200GR	GPM.95/BC/GR	10	p. 74
GP210	GPM.95/BC/FIX	10	p. 74
GP210GR	GPM.95/BC/FIX/GR	10	p. 74
GP300	GPM.95/CC	10	p. 77
GP300GR	GPM.95/CC/GR	10	p. 77
GP310	GPM.95/CC/FIX	10	p. 77
GP310GR	GPM.95/CC/FIX/GR	10	p. 77
GP400	GPM.150/BB	6	p. 72
GP400GR	GPM.150/BB/GR	6	p. 72
GP410	GPM.150/BB/FIX	6	p. 72
GP410GR	GPM.150/BB/FIX/GR	6	p. 72

CODE	TYPE	QTY. per pk.	PAGE
GP420	GPM.150/O/BB	6	p. 80
GP425	GPM.150/C/BB	6	p. 80
GP430	GPM.150/O/BB/FIX	6	p. 81
GP435	GPM.150/C/BB/FIX	6	p. 81
GP500	GPM.150/BC	6	p. 75
GP500GR	GPM.150/BC/GR	5	p. 75
GP510	GPM.150/BC/FIX	4	p. 75
GP510GR	GPM.150/BC/FIX/GR	4	p. 75
GP600	GPM.150/CC	6	p. 78
GP600GR	GPM.150/CC/GR	6	p. 78
GP610	GPM.150/CC/FIX	6	p. 78
GP610GR	GPM.150/CC/FIX/GR	6	p. 78
GP700	GPM.240/BB	4	p. 73
GP700GR	GPM.240/BB/GR	4	p. 73
GP710	GPM.240/BB/FIX	4	p. 73
GP710GR	GPM.240/BB/FIX/GR	4	p. 73
GP720	GPM.240/O/BB	4	p. 81
GP725	GPM.240/C/BB	4	p. 81
GP730	GPM.240/O/BB/FIX	4	p. 81
GP735	GPM.240/C/BB/FIX	4	p. 81
GP800	GPM.240/BC	4	p. 76
GP800GR	GPM.240/BC/GR	4	p. 76
GP810	GPM.240/BC/FIX	4	p. 76
GP810GR	GPM.240/BC/FIX/GR	4	p. 76
GP900	GPM.240/CC	4	p. 79
GP900GR	GPM.240/CC/GR	4	p. 79
GP910	GPM.240/CC/FIX	4	p. 79
GP910GR	GPM.240/CC/FIX/GR	4	p. 79
H			
HB100GR	HSCB.4/GR	90	p. 50
HB101GR	HSCB.4/PT/GR	25	p. 152
HB200GR	HSCB.6/GR	60	p. 50
HB201GR	HSCB.6/PT/GR	25	p. 152
HB203	HSCB.6/PO/2	40	p. 172
HB204	HSCB.6/PO/4	20	p. 172
HB205	HSCB.6/CPM	40	p. 172
HC200GR	HCD.1/GR	40	p. 53
HC201GR	HCD.1/PT/GR	25	p. 152
HC210	HCD.1 [EX]I	40	p. 53
HD100GR	HMD.2/GR	60	p. 45
HD101GR	HMD/PT/GR	25	p. 152
HD120GR	HMD.1/CI/GR	50	p. 43
HD130GR	HMD.1/X/GR	50	p. 46
HD200GR	HMD.1/GR	50	p. 43
HD201GR	HMD.1/PT/GR	25	p. 152
HD300	HMD.1 [EX]I	50	p. 43
HD301	HMD.1/PT[EX]i	25	p. 152
HD400GR	HMD.2N/GR	40	p. 44
HD410	HMD.2N [EX]I	40	p. 44
HD420GR	HMD.2N/DD/GR	40	p. 47
HD430GR	HMD.2/3DC/GR	40	p. 47
HD440GR	HMD.2N/X/GR	40	p. 46
HD441GR	HMD.2N/X1/GR	40	p. 46

CODE	TYPE	QTY. per pk.	PAGE
HD450GR	HMD.2N/CI/GR	40	p. 44
HD510	HLD.2 [EX]I	50	p. 48
HF111GR	HMF/PT/GR	25	p. 152
HF210GR	HFR.4/GR	70	p. 52
HF211GR	HFR.4/PT/GR	25	p. 152
HF300GR	HMFA.2/GR	80	p. 51
HF310GR	HFR.4/M/GR	100	p. 52
HI130	HP.2 [EX]I	100	p. 56
HI131	HPC.2 [EX]I	100	p. 57
HI132	HP.2 [EX]i	100	p. 56
HI210	HMM.4/1+2 [EX]I	40	p. 36
HI220	HMM.4/2+2 [EX]I	20	p. 36
HI250	HMM.4 [EX]I	60	p. 36
HI251	HMT.4/PT [EX]i	25	p. 152
HI320	HMM.6 [EX]I	30	p. 36
HI321	HMT.6/PT [EX]i	25	p. 152
HI330	HMM.10 [EX]I	30	p. 37
HI340	HMM.16 [EX]I	30	p. 37
HI400	HMM.1 [EX]I	100	p. 33
HI401	HMT.1/PT [EX]i	25	p. 152
HI410	HMM.1/1+2 [EX]I	80	p. 33
HI411	HMT.1/1+2/PT[EX]i	25	p. 152
HI420	HMM.1/2+2 [EX]I	60	p. 33
HI421	HMT.1/2+2/PT[EX]i	25	p. 152
HI500	HMM.2 [EX]I	80	p. 34
HI501	HMT.2/PT [EX]i	25	p. 152
HI510	HMM.2/1+2 [EX]I	80	p. 34
HI511	HMT.2/1+2/PT[EX]i	25	p. 152
HI520	HMM.2/2+2 [EX]I	60	p. 34
HI521	HMT.2/2+2/PT[EX]i	25	p. 152
HL200GR	HLD.2/GR	50	p. 48
HL201GR	HLD.2/PT/GR	25	p. 152
HL210GR	HLD.2/CI/GR	50	p. 48
HL500GR	HDE.2/GR	50	p. 48
HLT500	HTTE.2	50	p. 49
HM170GR	HMM.2/2+2/A/GR	60	p. 35
HM210GR	HMM.4/1+2/GR	40	p. 36
HM220GR	HMM.4/2+2/GR	40	p. 36
HM250GR	HMM.4/GR	60	p. 36
HM251GR	HMT.4/PT/GR	25	p. 152
HM320GR	HMM.6/GR	30	p. 37
HM321GR	HMT.6/PT/GR	25	p. 152
HM330GR	HMM.10/GR	30	p. 37
HM340GR	HMM.16/GR	30	p. 37
HM350GR	HMR.16/GR	15	p. 38
HM360GR	HMR.16/D/GR	30	p. 38
HM400GR	HMM.1/GR	100	p. 33
HM401GR	HMT.1/PT/GR	25	p. 152
HM410GR	HMM.1/1+2/GR	80	p. 33
HM411GR	HMT.1/1+2/PT	25	p. 152
HM420GR	HMM.1/2+2/GR	60	p. 33
HM421GR	HMT.1/2+2/PT	25	p. 152

CODE	TYPE	QTY. per pk.	PAGE
HM500GR	HMM.2/GR	80	p. 34
HM501GR	HMT.2/PT/GR	25	p. 152
HM510GR	HMM.2/1+2/GR	80	p. 34
HM511GR	HMT.2/1+2/PT/GR	25	p. 152
HM520GR	HMM.2/2+2/GR	60	p. 34
HM521GR	HMT.2/2+2/PT/GR	25	p. 152
HMS10GR	HMM.2/2+2/S/GR	60	p. 35
HMS20GR	HMM.2/1+2/S/GR	80	p. 35
HP101GR	HP/PT/GR	25	p. 152
HP150GR	HP.2/GR	100	p. 56
HP160GR	HPC.2/GR	100	p. 57
HP170GR	HPP.2/GR	100	p. 56
HS200GR	HMS.2/GR	80	p. 50
HT250	HTE.4	60	p. 41
HT260	HTE.4/1+2	40	p. 41
HT270	HTE.4/2+2	20	p. 41
HT320	HTE.6	30	p. 42
HT330	HTE.10	30	p. 42
HT340	HTE.16	30	p. 42
HT400	HTE.1	80	p. 39
HT410	HTE.1/1+2	80	p. 39
HT420	HTE.1/2+2	60	p. 39
HT500	HTE.2	80	p. 40
HT510	HTE.2/1+2	80	p. 40
HT520	HTE.2/2+2	60	p. 40
HV111GR	HPV/PT/GR	25	p. 152
HVP300GR	HVPC.2/GR	120	p. 54
HVP305	HVPC.2 [EX]I	120	p. 54
HVP900GR	CHP.2/GR	20	p. 54
HVP905	CHP.2 [EX]I	20	p. 54
HVP910GR	CHP.2D/GR	20	p. 54
HVP915	CHP.2D [EX]I	20	p. 54
HVT500	HVTE.2	80	p. 55
HVT900	CHTE.2	20	p. 55
HVT910	CHTE.2D	20	p. 55
KIT1224	KITLSN/12-24	1	p. 173
KIT70380	KITLSN/70-380	50	p. 173
MA100	MAC.6	80	p. 128
MA110	CAM	100	p. 128
MB100	MBL.50/6	10	p. 84
MB200	MBL.95/8	10	p. 84
MB300	MBL.120/10	10	p. 85
MB400	MBL.150/12	10	p. 85
MF100	MPFA.4	100	p. 101
MF100GR	MPFA.4/GR	100	p. 101
MP901	MPS.4/PT	25	p. 152
MP901GR	MPS.4/PT/GR	25	p. 152
MP902	MPS.4/PT[EX]i	25	p. 152
MP950	MPS.4	100	p. 105
MP950GR	MPS.4/GR	100	p. 105
MP960	MPS.4/SW [EX]I	100	p. 105
MZ300N	MS/8X10/N	1	p. 136

N

CODE	TYPE	QTY. per pk.	PAGE
MZ300T	MS/8X10/T	1	p. 136
NU0800SP	NU0800SP	500	p. 189
NU08510	NU08510	500	p. 187
NU0851001	NU0851001	500	p. 187
NU0851001V	NU0851001V	500	p. 187
NU0851010	NU0851010	500	p. 187
NU0851010V	NU0851010V	500	p. 187
NU0851011	NU0851011	500	p. 187
NU0851011V	NU0851011V	500	p. 187
NU0851012	NU0851012	500	p. 187
NU0851012V	NU0851012V	500	p. 187
NU0851013	NU0851013	500	p. 187
NU0851013V	NU0851013V	500	p. 187
NU0851014	NU0851014	500	p. 187
NU0851014V	NU0851014V	500	p. 187
NU0851015	NU0851015	500	p. 187
NU0851015V	NU0851015V	500	p. 187
NU0851016	NU0851016	500	p. 187
NU0851016V	NU0851016V	500	p. 187
NU0851017	NU0851017	500	p. 187
NU0851017V	NU0851017V	500	p. 187
NU0851018	NU0851018	500	p. 187
NU0851018V	NU0851018V	500	p. 187
NU0851019	NU0851019	500	p. 187
NU0851019V	NU0851019V	500	p. 187
NU0851020	NU0851020	500	p. 187
NU0851020V	NU0851020V	500	p. 187
NU085102A	NU085102A	500	p. 187
NU085102AV	NU085102AV	500	p. 187
NU0851051	NU0851051	500	p. 187
NU0851051V	NU0851051V	500	p. 187
NU08510L1	NU08510L1	500	p. 187
NU08510L1V	NU08510L1V	500	p. 187
NU08510L2	NU08510L2	500	p. 187
NU08510L2V	NU08510L2V	500	p. 187
NU08510L3	NU08510L3	500	p. 187
NU08510L3V	NU08510L3V	500	p. 187
NU08510NI	NU08510NI	500	p. 187
NU08510NIV	NU08510NIV	500	p. 187
NU08510PE	NU08510PE	500	p. 187
NU08510PEV	NU08510PEV	500	p. 187
NU08510R1	NU08510R1	500	p. 187
NU08510R1V	NU08510R1V	500	p. 187
NU08510S1	NU08510S1	500	p. 187
NU08510S1V	NU08510S1V	500	p. 187
NU08510S2	NU08510S2	500	p. 187
NU08510S2V	NU08510S2V	500	p. 187
NU08510S3	NU08510S3	500	p. 187
NU08510S3V	NU08510S3V	500	p. 187
NU08510U1	NU08510U1	500	p. 187
NU08510U1V	NU08510U1V	500	p. 187
NU08510U2	NU08510U2	500	p. 187

CODE	TYPE	QTY. per pk.	PAGE
NU08510U2V	NU08510U2V	500	p. 187
NU08510V	NU08510V	500	p. 187
NU08510V1	NU08510V1	500	p. 187
NU08510V1V	NU08510V1V	500	p. 187
NU08510V2	NU08510V2	500	p. 187
NU08510V2V	NU08510V2V	500	p. 187
NU08510W1	NU08510W1	500	p. 187
NU08510W1V	NU08510W1V	500	p. 187
NU08510W2	NU08510W2	500	p. 187
NU08510W2V	NU08510W2V	500	p. 187
NU08511	NU08511	500	p. 187
NU085110	NU085110	500	p. 187
NU0851101	NU0851101	500	p. 187
NU0851101V	NU0851101V	500	p. 187
NU085110V	NU085110V	500	p. 187
NU085111	NU085111	500	p. 187
NU085111V	NU085111V	500	p. 187
NU085112	NU085112	500	p. 187
NU085112V	NU085112V	500	p. 187
NU085114	NU085114	500	p. 187
NU085114V	NU085114V	500	p. 187
NU085115	NU085115	500	p. 187
NU0851151	NU0851151	500	p. 187
NU0851151V	NU0851151V	500	p. 187
NU085115V	NU085115V	500	p. 187
NU08511V	NU08511V	500	p. 187
NU08512	NU08512	500	p. 187
NU0851201	NU0851201	500	p. 187
NU0851201V	NU0851201V	500	p. 187
NU0851251	NU0851251	500	p. 187
NU0851251V	NU0851251V	500	p. 187
NU08512V	NU08512V	500	p. 187
NU08513	NU08513	500	p. 187
NU0851301	NU0851301	500	p. 187
NU0851301V	NU0851301V	500	p. 187
NU0851351	NU0851351	500	p. 187
NU0851351V	NU0851351V	500	p. 187
NU08513V	NU08513V	500	p. 187
NU08514	NU08514	500	p. 187
NU0851401	NU0851401	500	p. 187
NU0851401V	NU0851401V	500	p. 187
NU0851451	NU0851451	500	p. 187
NU0851451V	NU0851451V	500	p. 187
NU08514V	NU08514V	500	p. 187
NU08515	NU08515	500	p. 188
NU0851501	NU0851501	500	p. 187
NU0851501V	NU0851501V	500	p. 187
NU0851510	NU0851510	500	p. 188
NU0851510V	NU0851510V	500	p. 188
NU0851520	NU0851520	500	p. 188
NU0851520V	NU0851520V	500	p. 188
NU0851530	NU0851530	500	p. 188

CODE	TYPE	QTY. per pk.	PAGE
NU0851530V	NU0851530V	500	p. 188
NU0851540	NU0851540	500	p. 188
NU0851540V	NU0851540V	500	p. 188
NU0851550	NU0851550	500	p. 188
NU0851550V	NU0851550V	500	p. 188
NU0851551	NU0851551	500	p. 188
NU0851551V	NU0851551V	500	p. 188
NU0851560	NU0851560	500	p. 188
NU0851560V	NU0851560V	500	p. 188
NU0851570	NU0851570	500	p. 188
NU0851570V	NU0851570V	500	p. 188
NU0851580	NU0851580	500	p. 188
NU0851580V	NU0851580V	500	p. 188
NU0851590	NU0851590	500	p. 188
NU0851590V	NU0851590V	500	p. 188
NU08515V	NU08515V	500	p. 188
NU08516	NU08516	500	p. 188
NU0851600	NU0851600	500	p. 188
NU0851600V	NU0851600V	500	p. 188
NU0851601	NU0851601	500	p. 188
NU0851601V	NU0851601V	500	p. 188
NU0851651	NU0851651	500	p. 188
NU0851651V	NU0851651V	500	p. 188
NU08516V	NU08516V	500	p. 188
NU08517	NU08517	500	p. 188
NU0851701	NU0851701	500	p. 188
NU0851701V	NU0851701V	500	p. 188
NU0851751	NU0851751	500	p. 188
NU0851751V	NU0851751V	500	p. 188
NU08517V	NU08517V	500	p. 188
NU08518	NU08518	500	p. 188
NU0851801	NU0851801	500	p. 188
NU0851801V	NU0851801V	500	p. 188
NU0851851	NU0851851	500	p. 188
NU0851851V	NU0851851V	500	p. 188
NU08518V	NU08518V	500	p. 188
NU08519	NU08519	500	p. 188
NU0851901	NU0851901	500	p. 188
NU0851901V	NU0851901V	500	p. 188
NU0851951	NU0851951	500	p. 188
NU0851951V	NU0851951V	500	p. 188
NU08519V	NU08519V	500	p. 188
NU0851A	NU0851A	500	p. 188
NU0851AV	NU0851AV	500	p. 188
NU0851B	NU0851B	500	p. 188
NU0851BV	NU0851BV	500	p. 188
NU0851C	NU0851C	500	p. 188
NU0851CV	NU0851CV	500	p. 188
NU0851D	NU0851D	500	p. 188
NU0851DV	NU0851DV	500	p. 188
NU0851E	NU0851E	500	p. 188
NU0851EV	NU0851EV	500	p. 188

CODE	TYPE	QTY. per pk.	PAGE
NU0851F	NU0851F	500	p. 188
NU0851FV	NU0851FV	500	p. 188
NU0851G	NU0851G	500	p. 188
NU0851GV	NU0851GV	500	p. 188
NU0851H	NU0851H	500	p. 188
NU0851HV	NU0851HV	500	p. 188
NU0851I	NU0851I	500	p. 188
NU0851IV	NU0851IV	500	p. 188
NU0851J	NU0851J	500	p. 188
NU0851JV	NU0851JV	500	p. 188
NU0851K	NU0851K	500	p. 188
NU0851KV	NU0851KV	500	p. 188
NU0851L	NU0851L	500	p. 188
NU0851LV	NU0851LV	500	p. 188
NU0851M	NU0851M	500	p. 188
NU0851MV	NU0851MV	500	p. 188
NU0851N	NU0851N	500	p. 188
NU0851NV	NU0851NV	500	p. 188
NU0851O	NU0851O	500	p. 188
NU0851OV	NU0851OV	500	p. 188
NU0851P	NU0851P	500	p. 188
NU0851PV	NU0851PV	500	p. 188
NU0851Q	NU0851Q	500	p. 188
NU0851QV	NU0851QV	500	p. 188
NU0851R	NU0851R	500	p. 188
NU0851RV	NU0851RV	500	p. 188
NU0851S	NU0851S	500	p. 187
NU0851S	NU0851S	500	p. 187
NU0851S	NU0851S	500	p. 187
NU0851SP	NU0851SP	500	p. 189
NU0851SV	NU0851SV	500	p. 188
NU0851T	NU0851T	500	p. 188
NU0851TV	NU0851TV	500	p. 188
NU0851U	NU0851U	500	p. 188
NU0851UV	NU0851UV	500	p. 188
NU0851V	NU0851V	500	p. 188
NU0851VW	NU0851VW	500	p. 188
NU0851W	NU0851W	500	p. 188
NU0851WV	NU0851WV	500	p. 188
NU0851X	NU0851X	500	p. 188
NU0851XV	NU0851XV	500	p. 188
NU0851Y	NU0851Y	500	p. 188
NU0851YV	NU0851YV	500	p. 188
NU0851Z	NU0851Z	500	p. 188
NU0851ZV	NU0851ZV	500	p. 188
NU0861SP	NU0861SP	400	p. 189
NU1051SP	NU1051SP	500	p. 189
NU1055SP	NU1055SP	450	p. 189
NU1061SP	NU1061SP	400	p. 189
NU1065SP	NU1065SP	400	p. 189
NUL1061SP	NUL1061		p. 189
NUPUTUK50SP	NUPUTUK50SP		p. 189

P

CODE	TYPE	QTY. per pk.	PAGE
NUT12SP	NUT12SP	300	p. 190
NUT12YSP	NUT12YSP		p. 190
NUT15SP	NUT15SP	400	p. 190
NUT15YSP	NUT15YSP		p. 190
NUT18SP	NUT18SP		p. 190
NUT18YSP	NUT18YSP		p. 190
NUT23SP	NUT23SP		p. 190
NUT23YSP	NUT23YSP		p. 190
NUWDK50SP	NUWDK50SP		p. 189
NUWDU50SP	NUWDU50SP	500	p. 189
NUWG051SP	NUWG051SP		p. 189
PD001	PSD/A	50	p. 170
PD002	PSD/B	50	p. 170
PD003	PSD/C	50	p. 170
PD004	PSD/D	50	p. 170
PD009	PSD/L	50	p. 170
PD011	PSD/K	50	p. 170
PD013	PSD/N	50	p. 170
PD014	PSD/J	50	p. 170
PD015	PSD/P	50	p. 170
PD017	PSD/O	50	p. 170
PF100	PDF.2	75	p. 124
PF100GR	PDF.2/GR	75	p. 124
PF101	PDF/PT	25	p. 152
PIL02	PIL/2	15	p. 160
PIL03	PIL/3	15	p. 160
PIL04	PIL/4	15	p. 160
PIL08	PIL/8	10	p. 160
PM100	PM/10/10	10	p. 160
PM102	PM/10/2	25	p. 160
PM103	PM/10/3	25	p. 160
PM105	PM/10/5	25	p. 160
PM110	PM/11/10	10	p. 160
PM112	PM/11/2	25	p. 160
PM113	PM/11/3	25	p. 160
PM115	PM/11/5	25	p. 160
PM120	PM/12/10	10	p. 160
PM122	PM/12/2	25	p. 160
PM123	PM/12/3	25	p. 160
PM125	PM/12/5	25	p. 160
PM202	PM/20/2	25	p. 160
PM203	PM/20/3	25	p. 160
PM205	PM/20/5	25	p. 160
PM210	PM/20/10	10	p. 160
PM250	PM/25/10	10	p. 160
PM252	PM/25/2	25	p. 160
PM253	PM/25/3	25	p. 160
PM255	PM/25/5	25	p. 160
PM303	PM/30/3	25	p. 160
PM305	PM/30/5	25	p. 160
PM310	PM/30/10	10	p. 160
PM400	PM/40/10	10	p. 160

CODE	TYPE	QTY. per pk.	PAGE
PM402	PM/40/2	25	p. 160
PM403	PM/40/3	25	p. 160
PM405	PM/40/5	25	p. 160
PM412	PM/41/2	25	p. 160
PM510	PM/51/10	10	p. 160
PM513	PM/51/3	25	p. 160
PM515	PM/51/5	25	p. 160
PM602	PM/60/2	25	p. 160
PM603	PM/60/3	25	p. 160
PM605	PM/60/5	25	p. 160
PM610	PM/60/10	10	p. 160
PMP01	PMP/01	8	p. 167
PMP02	PMP/02	8	p. 167
PMP04	PMP/04	8	p. 167
PMP05	PMP/05	8	p. 167
PMP06	PMP/06	8	p. 167
PMP07	PMP/07	8	p. 167
PMP08	PMP/08	8	p. 167
PMP13	PMP/13	8	p. 167
PMP16	PMP/16	8	p. 167
PMP25	PMP/25	8	p. 167
PMP35	PMP/35	8	p. 167
PMP42	PMP/42	8	p. 167
PMP56	PMP/56	8	p. 167
PMP58	PMP/58	8	p. 167
PO162	POF/150/2	10	p. 166
PO163	POF/150/3	10	p. 166
PO242	POF/240/2	10	p. 166
PO243	POF/240/3	10	p. 166
PO952	POF/95/2	10	p. 166
PO953	POF/95/3	10	p. 166
POF06	POF/06	15	p. 166
POF07	POF/07	15	p. 166
POF08	POF/08	15	p. 166
POF35	POF/35	15	p. 166
POF44	POF/44	25	p. 166
POF53	POF/53	25	p. 166
POF56	POF/56	25	p. 166
POF57	POF/57	25	p. 166
POF70	POF/70	25	p. 166
POS08	POS/08	15	p. 168
POS11	POS/11	25	p. 168
POS41	POS/41	25	p. 168
POS42	POS/42	25	p. 168
POS43	POS/43	25	p. 168
POS44	POS/44	25	p. 168
POS53	POS/53	15	p. 168
POS66	POS/66	25	p. 168
POS72	POS/72	25	p. 168
POS77	POS/77	25	p. 168
POS93	POS/93	25	p. 168
PR001	PR/DIN/AC	20	p. 155

CODE	TYPE	QTY. per pk.	PAGE
PR002	PR/DIN/AL	20	p. 155
PR003	PR/3/AC	40	p. 155
PR004	PR/DIN/AS	20	p. 155
PR005	PR/3/AS	40	p. 155
PR006	PR/3/PA	20	p. 155
PR007	PR/3/PP	20	p. 155
PR009	PR/2/AC	100	p. 155
PR010	PR/2/AS	100	p. 155
PR901	PR/DIN/AC/ZB	20	p. 155
PR903	PR/3/AC/ZB	40	p. 155
PR904	PR/DIN/AS/ZB	20	p. 155
PR905	PR/3/AS/ZB	40	p. 155
PR906	PR/3/PA/ZB	20	p. 155
PR907	PR/3/PP/ZB	20	p. 155
PR909	PR/2/AC/ZB	100	p. 155
PR910	PR/2/AS/ZB	100	p. 155
PRP070G	PRP/7/G	10	p. 177
PTC0100	PTC/1/00	8	p. 161
PTC0102	PTC/1/02	25	p. 161
PTC0103	PTC/1/03	25	p. 161
PTC0105	PTC/1/05	25	p. 161
PTC0110	PTC/1/10	10	p. 161
PTC0200	PTC/2/00	8	p. 161
PTC0202	PTC/2/02	25	p. 161
PTC0203	PTC/2/03	25	p. 161
PTC0205	PTC/2/05	25	p. 161
PTC0210	PTC/2/10	10	p. 161
PTC0300	PTC/3/00	8	p. 161
PTC0302	PTC/3/02	25	p. 161
PTC0303	PTC/3/03	25	p. 161
PTC0305	PTC/3/05	25	p. 161
PTC0310	PTC/3/10	10	p. 161
PTC0400	PTC/4/00	8	p. 161
PTC0402	PTC/4/02	25	p. 161
PTC0403	PTC/4/03	25	p. 161
PTC0405	PTC/4/05	25	p. 161
PTC0410	PTC/4/10	10	p. 161
PTC0500	PTC/5/00	8	p. 161
PTC0502	PTC/5/02	25	p. 161
PTC0503	PTC/5/03	25	p. 161
PTC0505	PTC/5/05	25	p. 161
PTC0510	PTC/5/10	10	p. 161
PTC0600	PTC/6/00	8	p. 161
PTC0602	PTC/6/02	25	p. 161
PTC0603	PTC/6/03	25	p. 161
PTC0605	PTC/6/05	25	p. 161
PTC0610	PTC/6/10	10	p. 161
PTC0800	PTC/8/00	8	p. 161
PTC0802	PTC/8/02	25	p. 161
PTC0803	PTC/8/03	25	p. 161
PTC0805	PTC/8/05	25	p. 161
PTC0810	PTC/8/10	10	p. 161

CODE	TYPE	QTY. per pk.	PAGE
PTC1000	PTC/10/00	8	p. 161
PTC1002	PTC/10/02	25	p. 161
PTC1003	PTC/10/03	25	p. 161
PTC1005	PTC/10/05	25	p. 161
PTC1010	PTC/10/10	10	p. 161
PTC1100	PTC/11/00	8	p. 161
PTC1102	PTC/11/02	25	p. 161
PTC1103	PTC/11/03	25	p. 161
PTC1105	PTC/11/05	25	p. 161
PTC1110	PTC/11/10	10	p. 161
PTC1600	PTC/16/00	8	p. 161
PTC1602	PTC/16/02	25	p. 161
PTC1603	PTC/16/03	25	p. 161
PTC1605	PTC/16/05	25	p. 161
PTC1610	PTC/16/10	10	p. 161
PTC2000	PTC/20/00	8	p. 161
PTC2002	PTC/20/02	25	p. 161
PTC2003	PTC/20/03	25	p. 161
PTC2005	PTC/20/05	25	p. 161
PTC2010	PTC/20/10	10	p. 161
PTM	PTM	15	p. 154
PTMS	PTMS	36	p. 154
PTP0202B	PTP/2/02/B	25	p. 163
PTP0202R	PTP/2/02/R	25	p. 163
PTP0203B	PTP/2/03/B	25	p. 163
PTP0203R	PTP/2/03/R	25	p. 163
PTP0205B	PTP/2/05/B	25	p. 163
PTP0205R	PTP/2/05/R	25	p. 163
PTP0210B	PTP/2/10/B	25	p. 163
PTP0210R	PTP/2/10/R	25	p. 163
PTP0230B	PTP/2/30/B	25	p. 163
PTP0230R	PTP/2/30/R	25	p. 163
PTP0302B	PTP/3/02/B	25	p. 163
PTP0302R	PTP/3/02/R	25	p. 163
PTP0303B	PTP/3/03/B	25	p. 163
PTP0303R	PTP/3/03/R	25	p. 163
PTP0305B	PTP/3/05/B	25	p. 163
PTP0305R	PTP/3/05/R	25	p. 163
PTP0310B	PTP/3/10/B	25	p. 163
PTP0310R	PTP/3/10/R	25	p. 163
PTP0330B	PTP/3/30/B	25	p. 163
PTP0330R	PTP/3/30/R	25	p. 163
PTP0402B	PTP/4/02/B	25	p. 163
PTP0402R	PTP/4/02/R	25	p. 163
PTP0403B	PTP/4/03/B	25	p. 163
PTP0403R	PTP/4/03/R	25	p. 163
PTP0405B	PTP/4/05/B	25	p. 163
PTP0405R	PTP/4/05/R	25	p. 163
PTP0410B	PTP/4/10/B	25	p. 163
PTP0410R	PTP/4/10/R	25	p. 163
PTP0430B	PTP/4/30/B	25	p. 163
PTP0430R	PTP/4/30/R	25	p. 163

Q

CODE	TYPE	QTY. per pk.	PAGE
PTP0502B	PTP/5/02/B	25	p. 163
PTP0502R	PTP/5/02/R	25	p. 163
PTP0503B	PTP/5/03/B	25	p. 163
PTP0503R	PTP/5/03/R	25	p. 163
PTP0505B	PTP/5/05/B	25	p. 163
PTP0505R	PTP/5/05/R	25	p. 163
PTP0510B	PTP/5/10/B	25	p. 163
PTP0510R	PTP/5/10/R	25	p. 163
PTP0530B	PTP/5/30/B	25	p. 163
PTP0530R	PTP/5/30/R	25	p. 163
QBLOK1201	QBLOK.12/BLU	10	p. 137
QBLOK1202	QBLOK.12/TE	10	p. 137
QBLOK1203	QBLOK.12/GR	10	p. 137
QBLOK1P080E	QBLOK1P080A07E		p. 145
QBLOK1P125E	QBLOK1P125A08E		p. 145
QBLOK1P160	QBLOK1P160A6	1	p. 138
QBLOK1P160E	QBLOK1P160A08E		p. 145
QBLOK1P250	QBLOK1P250A10	1	p. 138
QBLOK1P250E	QBLOK1P250A12E		p. 146
QBLOK1P400	QBLOK1P400A10	1	p. 138
QBLOK1P400E	QBLOK1P400A12E		p. 146
QBLOK1P500E	QBLOK1P500A12E		p. 146
QBLOK2100	QBLOK2P100A7	4	p. 141
QBLOK2125	QBLOK2P125A11	2	p. 141
QBLOK2126	QBLOK2P125A15	2	p. 141
QBLOK4100	QBLOK4P100A7	2	p. 142
QBLOK4125	QBLOK4P125A11	1	p. 142
QBLOK4126	QBLOK4P125A15	1	p. 142
QBLOK4160S	QBLOK4P160A9	1	p. 143
QBLOK4161N	QBLOK4P160A14	1	p. 143
QBLOK7001	QBLOK.7/BLU	10	p. 137
QBLOK7002	QBLOK.7/TE	10	p. 137
QBLOK7003	QBLOK.7/GR	10	p. 137
QPOL1203	POLM.1215	10	p. 144
QPOL1204	POLM.1215/TE	10	p. 144
QPOL1205	POLM.1215/BLU	10	p. 144
RF101GR	RFN/PT/GR	25	p. 152
RF201	RFN/PT(Ex)i	25	p. 152
RN300GR	RN.1/GR	125	p. 129
RN400	RN.1 (EX)I	125	p. 129
RN500GR	RN.2/GR	110	p. 129
RN510	RN.2 (EX)I	110	p. 129
RP300GR	RP.4/GR	200	p. 129
RP301GR	RP.4/PT/GR	25	p. 152
RP400	RP.4 (EX)I	200	p. 129
RP401	RP.4/PT(Ex)i	25	p. 152
SB200	SCB.6	100	p. 110
SB200GR	SCB.6/GR	100	p. 110
SB201	SCB.6/PT	25	p. 152
SB201GR	SCB.6/PT/GR	25	p. 152
SB203	SCB.6/PO/2	40	p. 172
SB204	SCB.6/PO/4	20	p. 172

R

S

CODE	TYPE	QTY. per pk.	PAGE
SB205	SCB.6/CPM	25	p. 172
SB210	SCB.6/DD	80	p. 110
SB210GR	SCB.6/DD/GR	80	p. 110
SB220	SCB.6/CD	80	p. 110
SB220GR	SCB.6/CD/GR	80	p. 110
SB300	SCB.4	75	p. 108
SB300GR	SCB.4/GR	75	p. 108
SB301	SCB.4/PT	25	p. 152
SB301GR	SCB.4/PT/GR	25	p. 152
SB303	SCB.4/PO/2	40	p. 172
SB304	SCB.4/PO/4	20	p. 172
SB305	SCB.4/CPM	25	p. 172
SB400	SCB.10	80	p. 111
SB400GR	SCB.10/GR	80	p. 111
SB401	SCB.10/PT	25	p. 152
SB401GR	SCB.10/P/GR	25	p. 152
SB410	SCB.10/DD	80	p. 111
SB410GR	SCB.10/DD/GR	80	p. 111
SB420	SCB.10/CD	80	p. 111
SB420GR	SCB.10/CD/GR	80	p. 111
SC103	SCX/PO/2	40	p. 172
SC104	SCX/PO/4	20	p. 172
SC105	SCX/CPM	40	p. 172
SF401	SFO/PT	25	p. 152
SF401GR	SFO/PT/GR	25	p. 152
SF510	CIL/115-230	10	p. 173
SF518	CIL/12-48	10	p. 173
SF601	SFO/PT (Ex)i	25	p. 152
SF701	SFR/PT	25	p. 152
SF801	SFR/PT (Ex)i	25	p. 152
SF850	SFR.4 (EX)I	70	p. 97
SF850	SFR.4 (EX)I	70	p. 97
SF900	SFR.4	70	p. 97
SF900	SFR.4	70	p. 97
SF900	SFR.4	70	p. 97
SF900GR	SFR.4/GR	70	p. 97
SF900GR	SFR.4/GR	70	p. 97
SF900GR	SFR.4/GR	70	p. 97
SF901GR	SFR.4/D1/GR	70	p. 112
SF903GR	SFR.4/D3/GR	70	p. 112
SF910	SFR.4/VS	50	p. 99
SF910	SFR.4/VS	50	p. 99
SF910GR	SFR.4/VS/GR	50	p. 99
SF910GR	SFR.4/VS/GR	50	p. 99
SF923	SFR.4/C230	70	p. 103
SF923GR	SFR.4/C230/GR	70	p. 103
SF948	SFR.4/C48	70	p. 103
SF948GR	SFR.4/C48/GR	70	p. 103
SFR901	SFR.4/D1	70	p. 112
SFR903	SFR.4/D3	70	p. 112
SH004S	SH2.1	1500	p. 189
SH004SP	SH004SP	500	p. 189

CODE	TYPE	QTY. per pk.	PAGE
SN004SP	SNZ/4/SP	60	p. 189
SN008	SNZ/4/00	60	p. 189
SR300	SFR.6	50	p. 98
SR300	SFR.6	50	p. 98
SR300GR	SFR.6/GR	50	p. 98
SR300GR	SFR.6/GR	50	p. 98
SR301	SFR.6/PT	25	p. 152
SR400	SFR.6 (EXI)	50	p. 98
SR400	SFR.6 (EXI)	50	p. 98
SR401	SFR.6/PT(Ex)i	25	p. 152
SR500	SFR.6/M	50	p. 98
SR500	SFR.6/M	50	p. 98
SR500GR	SFR.6/M/GR	50	p. 98
SR500GR	SFR.6/M/GR	50	p. 98
SR600	SFR.6/M (EXI)	50	p. 98
SR600	SFR.6/M (EXI)	50	p. 98
TC500	TC/PO	125	p. 127
TC500GR	TC/PO/GR	125	p. 127
TC510	TC/PO (EXI)	125	p. 127
TE110	TE.6/D	50	p. 88
TE210	TE.16/D	30	p. 89
TE310	TE.50/D	15	p. 89
TE400	TED.4	65	p. 87
TE500	TE.10/D	35	p. 89
TH02	TH/2	50	p. 178
TH03	TH/3	50	p. 178
TL100	TLS.2	200	p. 95
TL100GR	TLS.2/GR	200	p. 95
TL101	TLS/PT	25	p. 152
TL200	TLD.2	125	p. 96
TL200GR	TLD.2/GR	125	p. 96
TL201	TLD/PT	25	p. 152
TL201GR	TLS/PT/GR	25	p. 152
TL300	TLD.2 (EXI)	125	p. 96
TL301	TLD/PT (Ex)i	25	p. 152
TL400	TLE.2	200	p. 96
TL400GR	TLE.2/GR	200	p. 96
TL500	TDE.2	125	p. 96
TL500GR	TDE.2/GR	125	p. 96
TO110	TE.6/O	45	p. 87
TO120	TEC.6/O	45	p. 62
TO210	TE.16/O	30	p. 88
TO220	TEC.16/O	30	p. 62
TO310	TE.50/O	15	p. 88
TO320	TEC.35/O	15	p. 63
TO430	TEO.4	50	p. 86
TO431	TEO.4/PT	25	p. 152
TO500	TE.10/O	35	p. 87
TO510	TEC.10/O	35	p. 62
TO810	TEC.70/O	25	p. 63
TO901	TEO.2/PT	50	p. 152
TO910	TEO.2	75	p. 86

CODE	TYPE	QTY. per pk.	PAGE
TP100	TPL.4	40	p. 131
TP200	TPL.4/PS	40	p. 132
TR110	TR.2	100	p. 130
TR111	TR.2/PT	25	p. 152
TR200	TR.4	50	p. 130
TTM04	TTM/04	10	p. 177
TTM12	TTM/12	10	p. 177
TTM15	TTM/15	10	p. 177
TUM05	TUM/05	10	p. 177
TUM06	TUM/06	10	p. 177
TUM07	TUM/07	10	p. 177
TUM08	TUM/08	10	p. 177
TUM16	TUM/16	10	p. 177
VL103	CO/5	50	p. 172
VP101	VPC/PT	25	p. 152
VP101GR	VPC/PT/GR	25	p. 152
VP201	VPC/PT (Ex)i	25	p. 152
VP300GR	VPC.2/GR	120	p. 125
VP310	VPC.2 (EXI)	120	p. 125
VP500GR	VPD.2/GR	40	p. 126
VP501GR	VPD/PT/GR	25	p. 152
VP560	VPD.2 (EXI)	40	p. 126
VP561	VPD/PT(Ex)i	25	p. 152
WP30002	WP5-14	500	p. 180
WP30003	WP5-16	500	p. 180
WP30005	WP75-14	500	p. 180
WP30006	WP75-16	500	p. 180
WP30009	WP1-14	500	p. 180
WP30010	WP1-18	500	p. 180
WP30013	WP15-14	500	p. 180
WP30014	WP15-18	500	p. 180
WP30016	WP25-14	500	p. 180
WP30017	WP25-19	500	p. 180
WP30019	WP40-16	500	p. 180
WP30020	WP40-20	500	p. 180
WP30022	WP60-20	100	p. 180
WP30023	WP60-26	500	p. 180
WP30024	WP100-21	100	p. 180
WP30025	WP100-28	500	p. 180
WP30026	WP160-22	100	p. 180
WP30027	WP160-28	500	p. 180
WP30028	WP250-29	50	p. 180
WP30029	WP250-32	500	p. 180
WP30030	WP350-30	50	p. 180
WP30031	WP350-41	500	p. 180
WP30032	WP500-40	50	p. 180
WP30033	WP500-41	500	p. 180
WP90001	WPD05/15	500	p. 181
WP90002	WPD75/15	500	p. 181
WP90003	WPD01/15	500	p. 181
WP90004	WPD15/16	500	p. 181
WP90005	WPD25/18	500	p. 181

CODE	TYPE	QTY. per pk.	PAGE
WP90006	WPD04/23	500	p. 181
WPN10508	WPN0508	1000	p. 181
WPN10758	WPN0758	1000	p. 181
WPN11010	WPN1010	1000	p. 181
WPN11015	WPN1015	500	p. 181
WPN11510	WPN1510	1000	p. 181
WPN11615	WPN1615	1000	p. 181
WPN12510	WPN2510	1000	p. 181
WPN12515	WPN2515	250	p. 181
WPN14012	WPN4012	1000	p. 181
WPN16012	WPN6012	500	p. 181
Z121017	ACI121017	25	p. 155
Z121019	ACI121019	25	p. 155
Z121026	ACI121026	100	p. 159
Z121116	ACI121116	10	p. 156
Z121118	ACI121118	50	p. 159
Z121119	ACI121119	100	p. 159
Z121121	ACI121121	100	p. 159
Z121123	ACI121123	1	p. 159
Z121211	ACI121211	25	p. 159
Z121212	ACI121212	25	p. 159
Z121213	ACI121213	20	p. 158
Z121214	ACI121214	20	p. 158
Z121215	ACI121215	20	p. 158
Z121216	ACI121216	10	p. 158
Z121217	ACI121217	10	p. 158
Z121218	ACI121218	10	p. 158
Z121219	ACI121219	10	p. 158
Z121221	ACI121221	50	p. 159
Z121228	ACI121228	20	p. 156
Z121301	ACI121301	10	p. 156
Z121307	ACI121307	50	p. 159
Z121311	ACI121311	20	p. 156
Z121314	ACI121314	20	p. 156
Z121316	ACI121316	20	p. 157
Z121317	ACI121317	10	p. 157
Z121318	ACI121318	10	p. 157
Z121319	ACI121319	10	p. 157
Z121410	ACI121410	10	p. 157
Z121415	ACI121415	20	p. 156
Z121421	ACI121421	100	p. 159

A

TYPE	CODE	QTY. per pk.	PAGE
ACB.120/BB	AC400	12	p. 82
ACB.185/BB	AC700	12	p. 82
ACB.70/BB	AC100	12	p. 82
ACI121017	Z121017	25	p. 155
ACI121019	Z121019	25	p. 155
ACI121026	Z121026	100	p. 159
ACI121116	Z121116	10	p. 156
ACI121118	Z121118	50	p. 159
ACI121119	Z121119	100	p. 159
ACI121121	Z121121	100	p. 159
ACI121123	Z121123	1	p. 159
ACI121211	Z121211	25	p. 159
ACI121212	Z121212	25	p. 159
ACI121213	Z121213	20	p. 158
ACI121214	Z121214	20	p. 158
ACI121215	Z121215	20	p. 158
ACI121216	Z121216	10	p. 158
ACI121217	Z121217	10	p. 158
ACI121218	Z121218	10	p. 158
ACI121219	Z121219	10	p. 158
ACI121221	Z121221	50	p. 159
ACI121228	Z121228	20	p. 156
ACI121301	Z121301	10	p. 156
ACI121307	Z121307	50	p. 159
ACI121311	Z121311	20	p. 156
ACI121314	Z121314	20	p. 156
ACI121316	Z121316	20	p. 157
ACI121317	Z121317	10	p. 157
ACI121318	Z121318	10	p. 157
ACI121319	Z121319	10	p. 157
ACI121410	Z121410	10	p. 157
ACI121415	Z121415	20	p. 156
ACI121421	Z121421	100	p. 159
AF0.2/1+1	AF500	100	p. 123
AF0.2/2+2	AF400	100	p. 123
AF0/PT	AF201	50	p. 152

B

BCA.120/BB	BC400	1	p. 83
BCA.70/BB	BC100	1	p. 83
BPL.4	BP100	60	p. 131
BPL.4/PS	BP300	60	p. 132
BPL/R	BP200	100	p. 131
BT/2	BT006	25	p. 153
BT/3	BT003	25	p. 153
BT0	BT007	25	p. 153
BTU	BT005	25	p. 153

C

CAM	MA110	100	p. 128
CAMUT.12/02	CAMUT02	10	p. 147
CAMUT.12/04	CAMUT04	10	p. 147

TYPE	CODE	QTY. per pk.	PAGE
CAMUT.12/06	CAMUT06	10	p. 147
CAMUT.12/10	CAMUT010	10	p. 147
CAMUT.12/16	CAMUT16	10	p. 147
CAMUT.12/25	CAMUT25	10	p. 147
CAMUT.12/35	CAMUT35	10	p. 147
CB10/PT	CB431	25	p. 152
CB10/PT (Ex)li	CBX44	25	p. 152
CB16/PT	CB511	25	p. 152
CB16/PT (Ex)li	CBX53	25	p. 152
CB2/PT	CB111	50	p. 152
CB2/PT (Ex)li	CBX13	50	p. 152
CB35/PT	CB611	25	p. 152
CB35/PT (Ex)li	CBX63	25	p. 152
CB4/6/PT	CB241	25	p. 152
CB4/6/PT (Ex)li	CBX25	25	p. 152
CB50/PT	CB711	10	p. 152
CB50/PT (Ex)li	CBX73	10	p. 152
CB70/PT	CB811	10	p. 152
CB70/PT (Ex)li	CBX83	10	p. 152
CBC.10 (EX)I	CBI10	100	p. 56
CBC.10/GR	CBC10GR	100	p. 56
CBC.16 (EX)I	CBI16	50	p. 56
CBC.16/GR	CBC16GR	50	p. 56
CBC.16/PT(Ex)li	CBI161	25	p. 152
CBC.16/PT/GR	CB161GR	25	p. 152
CBC.2 (EX)I	CBI02	120	p. 55
CBC.2-10/PT(Ex)li	CBI061	50	p. 152
CBC.2-10/PT/GR	CB061GR	50	p. 152
CBC.2/GR	CBC02GR	120	p. 55
CBC.35 (EX)I	CBI35	50	p. 56
CBC.35/GR	CBC35GR	50	p. 56
CBC.35/PT(Ex)li	CBI351	25	p. 152
CBC.35/PT/GR	CB351GR	25	p. 152
CBC.4 (EX)I	CBI04	100	p. 55
CBC.4/GR	CBC04GR	100	p. 55
CBC.6 (EX)I	CBI06	100	p. 55
CBC.6/GR	CBC06GR	100	p. 55
CBD.10	CB440	100	p. 68
CBD.10 (EX)I	CBX45	100	p. 68
CBD.16	CB510	50	p. 68
CBD.16 (EX)I	CBX52	50	p. 68
CBD.2	CB110	120	p. 67
CBD.2 (EX)I	CBX12	120	p. 67
CBD.35	CB610	75	p. 68
CBD.35 (EX)I	CBX62	75	p. 68
CBD.4	CB240	100	p. 67
CBD.4 (EX)I	CBX24	100	p. 67
CBD.50	CB710	50	p. 69

TYPE	CODE	QTY. per pk.	PAGE
CBD.50 (EX)I	CBX72	50	p. 69
CBD.50/GR	CB710GR	50	p. 69
CBD.6	CB340	100	p. 67
CBD.6 (EX)I	CBX34	100	p. 67
CBD.70	CB810	40	p. 69
CBD.70 (EX)I	CBX82	40	p. 69
CBD.70/GR	CB810GR	40	p. 69
CBD/SH	CB009	10	p. 172
CBE.2	CE110	70	p. 86
CBF.4	CBF04	50	p. 97
CBF.4 (Ex)li	CBF04I	50	p. 97
CBF.4/C23/GR	CBF423GR	50	p. 103
CBF.4/C48/GR	CBF448GR	50	p. 103
CBF.4/GR	CBF04GR	50	p. 97
CBR.2	CR110	75	p. 57
CBR.2 (EX)I	CI110	75	p. 57
CBR.2/GR	CR110GR	75	p. 57
CBR/PT	CR111	25	p. 152
CBS.2	CBS02	100	p. 104
CBS.2 (Ex) i	CBS02I	100	p. 104
CBS.2/GR	CBS02GR	100	p. 104
CBS.4	CBS04	80	p. 104
CBS.4 (Ex)li	CBS04I	80	p. 104
CBS.4/GR	CBS04GR	80	p. 104
CCH.2/5-4	CCH02	1	p. 179
CCH/6	CCH06	1	p. 179
CCV.2/5	CCV03	1	p. 179
CCV/4	CCV04	1	p. 179
CCV/5	CCV05	1	p. 179
CF.12/1+1	CF100	50	p. 133
CF.12/2+2	CF200	25	p. 133
CF.12/CPT	CF900	40	p. 133
CHP.2 (EX)I	HVP905	20	p. 54
CHP.2/GR	HVP900GR	20	p. 54
CHP.2D (EX)I	HVP915	20	p. 54
CHP.2D/GR	HVP910GR	20	p. 54
CHTE.2	HVT900	20	p. 55
CHTE.2D	HVT910	20	p. 55
CIL/115-230	SF510	10	p. 173
CIL/12-48	SF518	10	p. 173
CO/5	VL103	50	p. 172
CONT/1,5	CONTC01	10	p. 146
CONT/10	CONTC10	5	p. 146
CONT/16	CONTC16	5	p. 146
CONT/2,5	CONTC02	10	p. 146
CONT/2/06	CONT206	20	p. 145
CONT/2/16	CONT216	20	p. 145
CONT/2/25	CONT225	10	p. 145

TYPE	CODE	QTY. per pk.	PAGE
CONT/2/35	CONT235	5	p. 145
CONT/25	CONTC25	5	p. 146
CONT/3/16	CONT316	5	p. 145
CONT/3/6	CONT306	10	p. 145
CONT/4	CONTC04	10	p. 146
CONT/6	CONTC06	10	p. 146
CONT/6/6	CONT606	5	p. 145
CONT616	CONT616	5	p. 145
CPF/5	CPF05	20	p. 171
CPFE.2 + EFDS.2/1S/GR	EFDS212GR	30	p. 29
CPFE.2 + EFDS.2/GR	EFDS202GR	30	p. 29
CPFE.2 + EFS.2/GR	EFS202GR	35	p. 29
CPFE.4 + EFS.4/GR	EFS402GR	35	p. 29
CPFE/2	CPFE02	20	p. 171
CPFE/4	CPFE04	20	p. 171
CVF.4	CV100	100	p. 124
CVF.4/GR	CV100GR	100	p. 124
CVF/PT	CV101	25	p. 152
CVF/PT (Ex)i	CV201	25	p. 152
CVF/PT/GR	CV101GR	25	p. 152
DAS.4	DS100	120	p. 92
DAS.4 (EX)I	DS200	120	p. 92
DAS.4/A	DS111	20	p. 118
DAS.4/A/GR	DS111GR	20	p. 118
DAS.4/B	DS112	20	p. 118
DAS.4/B/GR	DS112GR	20	p. 118
DAS.4/C	DS113	20	p. 119
DAS.4/C/GR	DS113GR	20	p. 119
DAS.4/CI	DS117	120	p. 92
DAS.4/CI (EX)I	DS217	120	p. 92
DAS.4/CI/GR	DS117GR	120	p. 92
DAS.4/D	DS114	20	p. 119
DAS.4/D/GR	DS114GR	20	p. 119
DAS.4/D12	DSD012	20	p. 114
DAS.4/D12/GR	DSD012GR	20	p. 114
DAS.4/D24	DSD024	20	p. 115
DAS.4/D24/GR	DSD024GR	20	p. 115
DAS.4/D5	DSD005	20	p. 114
DAS.4/D5/GR	DSD005GR	20	p. 114
DAS.4/D60	DSD060	20	p. 115
DAS.4/D60/GR	DSD060GR	20	p. 115
DAS.4/DD	DS120	20	p. 121
DAS.4/DD/GR	DS120GR	20	p. 121
DAS.4/E	DS115	20	p. 120
DAS.4/E/GR	DS115GR	20	p. 120
DAS.4/GR	DS100GR	120	p. 92
DAS.4/I	DS119	20	p. 120
DAS.4/I/GR	DS119GR	20	p. 120

TYPE	CODE	QTY. per pk.	PAGE
DAS.4/L	DS130	20	p. 121
DAS.4/L/GR	DS130GR	20	p. 121
DAS.4/SS	DS110	20	p. 93
DAS.4/SS/GR	DS110GR	20	p. 93
DAS.4/T	DS128	20	p. 122
DAS.4/T/GR	DS128GR	20	p. 122
DAS.4/U	DS129	20	p. 122
DAS.4/U/GR	DS129GR	20	p. 122
DAS.4/V120	DSV120	20	p. 117
DAS.4/V120/GR	DSV120GR	20	p. 117
DAS.4/V230	DSV230	20	p. 117
DAS.4/V230/GR	DSV230GR	20	p. 117
DAS.4/V24	DSV024	20	p. 116
DAS.4/V24/GR	DSV024GR	20	p. 116
DAS.4/V48	DSV048	20	p. 116
DAS.4/V48/GR	DSV048GR	20	p. 116
DAS/PT	DS101	25	p. 152
DAS/PT (Ex)i	DS201	25	p. 152
DAS/VCE	DS108	25	p. 172
DAS/VCI	DS107	25	p. 172
DBC.2	DB100	120	p. 90
DBC.2 (EX)I	DB200	120	p. 90
DBC.2/CI	DB117	120	p. 90
DBC.2/CI/GR	DB117GR	120	p. 90
DBC.2/GR	DB100GR	120	p. 90
DBC.4 (Ex)i	DB500	100	p. 91
DBC.4/CI (Ex)i	DB517	100	p. 91
DBC.4/CI/GR	DB417GR	100	p. 91
DBC.4/GR	DB400GR	100	p. 91
DBC/PT	DB101	25	p. 152
DBC/PT(Ex)i	DB201	25	p. 152
DFE.1+1/R	DFE01R	20	p. 174
DFE.1+2/R	DFE02R	20	p. 174
DFE.2+2/R	DFE03R	20	p. 174
DFE.2P/R	DFE04R	20	p. 174
DFH/1/R	DH01R	25	p. 174
DFH/2/R	DH02R	25	p. 174
DFH/3/R	DH03R	25	p. 174
DFH/4/R	DH04R	25	p. 174
DFM/300	DF300	50	p. 175
DFM/400	DF400	50	p. 175
DFM/500	DF500	50	p. 175
DFM/600	DF600	50	p. 175
DFM/700	DF700	50	p. 175
DFM/800	DF800	50	p. 175
DFM/900	DF900	50	p. 175
DFP/2/R	DFP2R	50	p. 174
DFS.4/PT/GR	DS401GR	25	p. 152

TYPE	CODE	QTY. per pk.	PAGE
DFU/1/R	DU01R	50	p. 174
DFU/2/R	DU02R	50	p. 174
DFU/3/R	DU03R	50	p. 174
DFU/4/R	DU04R	50	p. 174
DFU/5/R	DU05R	50	p. 174
DFU/6/R	DU06R	50	p. 174
DFU/7/R	DU07R	50	p. 174
DSF.4	DA200	80	p. 100
DSF.4/GR	DA200GR	80	p. 100
DSFA.4	DA100	100	p. 101
DSFA.4/GR	DA100GR	100	p. 101
DSS.4	DS400	100	p. 93
DSS.4	DS400	100	p. 93
DSS.4/GR	DS400GR	100	p. 93
DSS.4/GR	DS400GR	100	p. 93
DSS/PT	DS301	25	p. 152
DSS/PT/GR	DS301GR	25	p. 152
EFB.2/10/B	EFB0210B	5	p. 165
EFB.2/10/R	EFB0210R	5	p. 165
EFB.2/2/B	EFB0202B	20	p. 165
EFB.2/2/R	EFB0202R	20	p. 165
EFB.2/3/B	EFB0203B	20	p. 165
EFB.2/3/R	EFB0203R	20	p. 165
EFB.2/5/B	EFB0205B	10	p. 165
EFB.2/5/R	EFB0205R	10	p. 165
EFB.4/10/B	EFB0410B	5	p. 165
EFB.4/10/R	EFB0410R	5	p. 165
EFB.4/2/B	EFB0402B	20	p. 165
EFB.4/2/R	EFB0402R	20	p. 165
EFB.4/3/B	EFB0403B	20	p. 165
EFB.4/3/R	EFB0403R	20	p. 165
EFB.4/5/B	EFB0405B	10	p. 165
EFB.4/5/R	EFB0405R	10	p. 165
EFC.1/1+2/BL	EFC110BL		p. 13
EFC.1/1+2/GR	EFC110GR		p. 13
EFC.1/2+2/BL	EFC120BL		p. 13
EFC.1/2+2/GR	EFC120GR		p. 13
EFC.1/BL	EFC100BL		p. 13
EFC.1/GR	EFC100GR		p. 13
EFC.2/1+2/BL	EFC210BL	120	p. 15
EFC.2/1+2/GR	EFC210GR	120	p. 15
EFC.2/1+2/PT/BL	EFC211BL	25	p. 152
EFC.2/1+2/PT/GR	EFC211GR	25	p. 152
EFC.2/2+2/BL	EFC220BL	90	p. 15
EFC.2/2+2/GR	EFC220GR	90	p. 15
EFC.2/2+2/PT/BL	EFC221BL	25	p. 152
EFC.2/2+2/PT/GR	EFC221GR	25	p. 152
EFC.2/BL	EFC200BL	160	p. 15

TYPE	CODE	QTY. per pk.	PAGE
EFC.2/GR	EFC200GR	160	p. 15
EFC.2/PT/BL	EFC201BL	25	p. 152
EFC.2/PT/GR	EFC201GR	25	p. 152
EFC.4/1+2/BL	EFC410BL	110	p. 17
EFC.4/1+2/GR	EFC410GR	110	p. 17
EFC.4/1+2/PT/BL	EFC411BL	25	p. 152
EFC.4/1+2/PT/GR	EFC411GR	25	p. 152
EFC.4/2+2/BL	EFC420BL	90	p. 17
EFC.4/2+2/GR	EFC420GR	90	p. 17
EFC.4/2+2/PT/BL	EFC421BL	25	p. 152
EFC.4/2+2/PT/GR	EFC421GR	25	p. 152
EFC.4/BL	EFC400BL	120	p. 17
EFC.4/GR	EFC400GR	120	p. 17
EFC.4/PT/BL	EFC401BL	25	p. 152
EFC.4/PT/GR	EFC401GR	25	p. 152
EFC.6/1+2/BL	EFC610BL		p. 19
EFC.6/1+2/GR	EFC610GR		p. 19
EFC.6/BL	EFC600BL		p. 19
EFC.6/GR	EFC600GR		p. 19
EFCE.1	EFCE100		p. 14
EFCE.1/1+2	EFCE110		p. 14
EFCE.1/2+2	EFCE120		p. 14
EFCE.2	EFCE200	80	p. 16
EFCE.2/1+2	EFCE210	50	p. 16
EFCE.2/2+2	EFCE220	60	p. 16
EFCE.4	EFCE400	70	p. 18
EFCE.4/1+2	EFCE410	60	p. 18
EFCE.4/2+2	EFCE420	90	p. 18
EFCE.6	EFCE600		p. 20
EFCE.6/1+2	EFCE610		p. 20
EFD.1/BL	EFD100BL		p. 21
EFD.1/CI/BL	EFD110BL		p. 21
EFD.1/CI/GR	EFD110GR		p. 21
EFD.1/E/GR	EFD120GR		p. 21
EFD.1/GR	EFD100GR		p. 21
EFD.2/BL	EFD200BL	130	p. 22
EFD.2/CI/BL	EFD210BL	30	p. 22
EFD.2/CI/GR	EFD210GR	30	p. 22
EFD.2/E/GR	EFD220GR	30	p. 22
EFD.2/GR	EFD200GR	130	p. 22
EFD.2/PT/BL	EFD201BL	25	p. 152
EFD.2/PT/GR	EFD201GR	25	p. 152
EFD.4/BL	EFD400BL	100	p. 23
EFD.4/CI/BL	EFD410BL	40	p. 23
EFD.4/CI/GR	EFD410GR	40	p. 23
EFD.4/E/GR	EFD420GR	40	p. 23
EFD.4/GR	EFD400GR	100	p. 23
EFD.4/PT/BL	EFD401BL	25	p. 152

TYPE	CODE	QTY. per pk.	PAGE
EFD.4/PT/GR	EFD401GR	25	p. 152
EFDE.1	EFDE100		p. 24
EFDE.2	EFDE200	30	p. 24
EFDE.4	EFDE400	40	p. 24
EFDS.2/1S/GR	EFDS210GR	45	p. 27
EFDS.2/GR	EFDS200GR	45	p. 27
EFDS.2/P/GR	EFDS220GR	45	p. 27
EFDS.2/PT/GR	EFDS201GR	25	p. 152
EFF.4/BL	EFF400BL	35	p. 28
EFF.4/C230/GR	EFF423GR	35	p. 28
EFF.4/C48/GR	EFF448GR	35	p. 28
EFF.4/GR	EFF400GR	35	p. 28
EFS.2/BL	EFS200BL	75	p. 25
EFS.2/GR	EFS200GR	75	p. 25
EFS.4/BL	EFS400BL	70	p. 25
EFS.4/GR	EFS400GR	70	p. 25
EFT.2/BL	EFT200BL	100	p. 26
EFT.2/GR	EFT200GR	100	p. 26
EFT.2/PT/BL	EFT201BL	25	p. 152
EFT.2/PT/GR	EFT201GR	25	p. 152
EFT.2/S/GR	EFT250GR	100	p. 26
EFT.2/S/PT/GR	EFT251GR	25	p. 152
EFTE.2	EFTE200	35	p. 26
F5/1 A	FN006ST	100	p. 173
F5/1.6 A	FN007ST	100	p. 173
F5/10 A	FN015ST	100	p. 173
F5/100 mA	FN001ST	100	p. 173
F5/12 A	FN016ST	100	p. 173
F5/2 A	FN008ST	100	p. 173
F5/2.5 A	FN009ST	100	p. 173
F5/200 mA	FN002ST	100	p. 173
F5/3.15 A	FN010ST	100	p. 173
F5/315 mA	FN003ST	100	p. 173
F5/4 A	FN011ST	100	p. 173
F5/5 A	FN012ST	100	p. 173
F5/500 mA	FN004ST	100	p. 173
F5/6.3 A	FN013ST	100	p. 173
F5/630 mA	FN005ST	100	p. 173
F5/8 A	FN014ST	100	p. 173
FDP.2	FD100	70	p. 124
FDP.2/GR	FD100GR	70	p. 124
FDP/PT	FD101	25	p. 152
FDP/PT/GR	FD101GR	25	p. 152
FFS.4	FF100	120	p. 94
FFS.4/GR	FF100GR	120	p. 94
FFS/PT	FF101	25	p. 152
FFS/PT/GR	FF101GR	25	p. 152
FJ402	FJ402	80	p. 148

TYPE	CODE	QTY. per pk.	PAGE
FJ403	FJ403	60	p. 148
FL201	FL201	100	p. 173
FL202	FL202	100	p. 173
FPC.10	FP100	70	p. 102
FPC.10	FP100	70	p. 102
FPL.10/C	FP300	70	p. 102
FPL.10/C230	FP923	70	p. 103
FPL.10/C48	FP948	70	p. 103
FPL.10/L	FP200	70	p. 102
FVS.4	FV100	120	p. 94
FVS.4/GR	FV100GR	120	p. 94
FVS/PT	FV101	25	p. 152
FVS/PT/GR	FV101GR	25	p. 152
FVS/VCE	FV108	25	p. 172
FVS/VCI	FV107	25	p. 172
GPA.150	GA200	8	p. 60
GPA.150/FIX	GF200	8	p. 60
GPA.150/FX/GR	GF200GR	8	p. 60
GPA.150/GR	GA200GR	8	p. 60
GPA.240	GA300	4	p. 61
GPA.240/FIX	GF300	4	p. 61
GPA.240/FIX/GR	GF300GR	4	p. 61
GPA.240/GR	GA300GR	4	p. 61
GPA.70	GA400	25	p. 58
GPA.70 [EXI]	GA410	25	p. 58
GPA.70/FIX	GF400	25	p. 58
GPA.70/FIX/GR	GF400GR	25	p. 58
GPA.70/GR	GA400GR	25	p. 58
GPA.95	GA100	10	p. 59
GPA.95 [EXI]	GA110	10	p. 59
GPA.95/FIX	GF100	10	p. 59
GPA.95/FIX/GR	GF100GR	10	p. 59
GPA.95/GR	GA100GR	10	p. 59
GPM.150/BB	GP400	6	p. 72
GPM.150/BB/FIX	GP410	6	p. 72
GPM.150/BB/FIX/GR	GP410GR	6	p. 72
GPM.150/BB/GR	GP400GR	6	p. 72
GPM.150/BC	GP500	6	p. 75
GPM.150/BC/FIX	GP510	4	p. 75
GPM.150/BC/FIX/GR	GP510GR	4	p. 75
GPM.150/BC/GR	GP500GR	5	p. 75
GPM.150/C/BB	GP425	6	p. 80
GPM.150/C/BB/FIX	GP435	6	p. 81
GPM.150/CC	GP600	6	p. 78
GPM.150/CC/FIX	GP610	6	p. 78
GPM.150/CC/FIX/GR	GP610GR	6	p. 78
GPM.150/CC/GR	GP600GR	6	p. 78
GPM.150/O/BB	GP420	6	p. 80

TYPE	CODE	QTY. per pk.	PAGE
GPM.150/O/BB/FIX	GP430	6	p. 81
GPM.240/BB	GP700	4	p. 73
GPM.240/BB/FIX	GP710	4	p. 73
GPM.240/BB/FIX/GR	GP710GR	4	p. 73
GPM.240/BB/GR	GP700GR	4	p. 73
GPM.240/BC	GP800	4	p. 76
GPM.240/BC/FIX	GP810	4	p. 76
GPM.240/BC/FIX/GR	GP810GR	4	p. 76
GPM.240/BC/GR	GP800GR	4	p. 76
GPM.240/C/BB	GP725	4	p. 81
GPM.240/C/BB/FIX	GP735	4	p. 81
GPM.240/CC	GP900	4	p. 79
GPM.240/CC/FIX	GP910	4	p. 79
GPM.240/CC/FIX/GR	GP910GR	4	p. 79
GPM.240/CC/GR	GP900GR	4	p. 79
GPM.240/O/BB	GP720	4	p. 81
GPM.240/O/BB/FIX	GP730	4	p. 81
GPM.95/BB	GP100	10	p. 71
GPM.95/BB/FIX	GP110	10	p. 71
GPM.95/BB/FIX/GR	GP110GR	10	p. 71
GPM.95/BB/GR	GP100GR	10	p. 71
GPM.95/BC	GP200	10	p. 74
GPM.95/BC/FIX	GP210	10	p. 74
GPM.95/BC/FIX/GR	GP210GR	10	p. 74
GPM.95/BC/GR	GP200GR	10	p. 74
GPM.95/C/BB	GP125	10	p. 80
GPM.95/C/BB/FIX	GP135	10	p. 80
GPM.95/CC	GP300	10	p. 77
GPM.95/CC/FIX	GP310	10	p. 77
GPM.95/CC/FIX/GR	GP310GR	10	p. 77
GPM.95/CC/GR	GP300GR	10	p. 77
GPM.95/O/BB	GP120	10	p. 80
GPM.95/O/BB/FIX	GP130	10	p. 80
H HCD.1 [EX]I	HC210	40	p. 53
HCD.1/GR	HC200GR	40	p. 53
HCD.1/PT/GR	HC201GR	25	p. 152
HDE.2/GR	HL500GR	50	p. 48
HFR.4/GR	HF210GR	70	p. 52
HFR.4/M/GR	HF310GR	100	p. 52
HFR.4/PT/GR	HF211GR	25	p. 152
HLD.2 [EX]I	HD510	50	p. 48
HLD.2/CI/GR	HL210GR	50	p. 48
HLD.2/GR	HL200GR	50	p. 48
HLD.2/PT/GR	HL201GR	25	p. 152
HMD.1 [EX]I	HD300	50	p. 43
HMD.1/CI/GR	HD120GR	50	p. 43
HMD.1/GR	HD200GR	50	p. 43
HMD.1/PT[EX]i	HD301	25	p. 152

TYPE	CODE	QTY. per pk.	PAGE
HMD.1/PT/GR	HD201GR	25	p. 152
HMD.1/X/GR	HD130GR	50	p. 46
HMD.2/3DC/GR	HD430GR	40	p. 47
HMD.2/GR	HD100GR	60	p. 45
HMD.2N [EX]I	HD410	40	p. 44
HMD.2N/CI/GR	HD450GR	40	p. 44
HMD.2N/DD/GR	HD420GR	40	p. 47
HMD.2N/GR	HD400GR	40	p. 44
HMD.2N/X/GR	HD440GR	40	p. 46
HMD.2N/X1/GR	HD441GR	40	p. 46
HMD/PT/GR	HD101GR	25	p. 152
HMF/PT/GR	HF111GR	25	p. 152
HMFA.2/GR	HF300GR	80	p. 51
HMM.1 [EX]I	HI400	100	p. 33
HMM.1/1+2 [EX]I	HI410	80	p. 33
HMM.1/1+2/GR	HM410GR	80	p. 33
HMM.1/2+2 [EX]I	HI420	60	p. 33
HMM.1/2+2/GR	HM420GR	60	p. 33
HMM.1/GR	HM400GR	100	p. 33
HMM.10 [EX]I	HI330	30	p. 37
HMM.10/GR	HM330GR	30	p. 37
HMM.16 [EX]I	HI340	30	p. 37
HMM.16/GR	HM340GR	30	p. 37
HMM.2 [EX]I	HI500	80	p. 34
HMM.2/1+2 [EX]I	HI510	80	p. 34
HMM.2/1+2/GR	HM510GR	80	p. 34
HMM.2/1+2/S/GR	HMS20GR	80	p. 35
HMM.2/2+2 [EX]I	HI520	60	p. 34
HMM.2/2+2/A/GR	HM170GR	60	p. 35
HMM.2/2+2/GR	HM520GR	60	p. 34
HMM.2/2+2/S/GR	HMS10GR	60	p. 35
HMM.2/GR	HM500GR	80	p. 34
HMM.4 [EX]I	HI250	60	p. 36
HMM.4/1+2 [EX]I	HI210	40	p. 36
HMM.4/1+2/GR	HM210GR	40	p. 36
HMM.4/2+2 [EX]I	HI220	20	p. 36
HMM.4/2+2/GR	HM220GR	40	p. 36
HMM.4/GR	HM250GR	60	p. 36
HMM.6 [EX]I	HI320	30	p. 36
HMM.6/GR	HM320GR	30	p. 37
HMR.16/D/GR	HM360GR	30	p. 38
HMR.16/GR	HM350GR	15	p. 38
HMS.2/GR	HS200GR	80	p. 50
HMT.1/1+2/PT	HM411GR	25	p. 152
HMT.1/1+2/PT[EX]i	HI411	25	p. 152
HMT.1/2+2/PT	HM421GR	25	p. 152
HMT.1/2+2/PT[EX]i	HI421	25	p. 152
HMT.1/PT [EX]i	HI401	25	p. 152

TYPE	CODE	QTY. per pk.	PAGE
HMT.1/PT/GR	HM401GR	25	p. 152
HMT.2/1+2/PT[EX]i	HI511	25	p. 152
HMT.2/1+2/PT/GR	HM511GR	25	p. 152
HMT.2/2+2/PT[EX]i	HI521	25	p. 152
HMT.2/2+2/PT/GR	HM521GR	25	p. 152
HMT.2/PT [EX]i	HI501	25	p. 152
HMT.2/PT/GR	HM501GR	25	p. 152
HMT.4/PT [EX]i	HI251	25	p. 152
HMT.4/PT/GR	HM251GR	25	p. 152
HMT.6/PT [EX]i	HI321	25	p. 152
HMT.6/PT/GR	HM321GR	25	p. 152
HP.2 [EX]I	HI130	100	p. 56
HP.2 [EX]i	HI132	100	p. 56
HP.2/GR	HP150GR	100	p. 56
HP/PT/GR	HP101GR	25	p. 152
HPC.2 [EX]I	HI131	100	p. 57
HPC.2/GR	HP160GR	100	p. 57
HPP.2/GR	HP170GR	100	p. 56
HPV/PT/GR	HV111GR	25	p. 152
HSCB.4/GR	HB100GR	90	p. 50
HSCB.4/PT/GR	HB101GR	25	p. 152
HSCB.6/CPM	HB205	40	p. 172
HSCB.6/GR	HB200GR	60	p. 50
HSCB.6/PT/GR	HB201GR	25	p. 152
HSCB.6/PO/2	HB203	40	p. 172
HSCB.6/PO/4	HB204	20	p. 172
HTE.1	HT400	80	p. 39
HTE.1/1+2	HT410	80	p. 39
HTE.1/2+2	HT420	60	p. 39
HTE.10	HT330	30	p. 42
HTE.16	HT340	30	p. 42
HTE.2	HT500	80	p. 40
HTE.2/1+2	HT510	80	p. 40
HTE.2/2+2	HT520	60	p. 40
HTE.4	HT250	60	p. 41
HTE.4/1+2	HT260	40	p. 41
HTE.4/2+2	HT270	20	p. 41
HTE.6	HT320	30	p. 42
HTTE.2	HLT500	50	p. 49
HVPC.2 [EX]I	HVP305	120	p. 54
HVPC.2/GR	HVP300GR	120	p. 54
HVTE.2	HVT500	80	p. 55
KITLSN/12-24	KIT1224	1	p. 173
M KITLSN/70-380	KIT70380	50	p. 173
MAC.6	MA100	80	p. 128
MBL.120/10	MB300	10	p. 85
MBL.150/12	MB400	10	p. 85
MBL.50/6	MB100	10	p. 84

N

TYPE	CODE	QTY. per pk.	PAGE
MBL.95/8	MB200	10	p. 84
MPFA.4	MF100	100	p. 101
MPFA.4/GR	MF100GR	100	p. 101
MPS.4	MP950	100	p. 105
MPS.4/GR	MP950GR	100	p. 105
MPS.4/PT	MP901	25	p. 152
MPS.4/PT(EX)I	MP902	25	p. 152
MPS.4/PT/GR	MP901GR	25	p. 152
MPS.4/SW (EX)I	MP960	100	p. 105
MS/8X10/N	MZ300N	1	p. 136
MS/8X10/T	MZ300T	1	p. 136
NU0800SP	NU0800SP	500	p. 189
NU08510	NU08510	500	p. 187
NU0851001	NU0851001	500	p. 187
NU0851001V	NU0851001V	500	p. 187
NU0851010	NU0851010	500	p. 187
NU0851010V	NU0851010V	500	p. 187
NU0851011	NU0851011	500	p. 187
NU0851011V	NU0851011V	500	p. 187
NU0851012	NU0851012	500	p. 187
NU0851012V	NU0851012V	500	p. 187
NU0851013	NU0851013	500	p. 187
NU0851013V	NU0851013V	500	p. 187
NU0851014	NU0851014	500	p. 187
NU0851014V	NU0851014V	500	p. 187
NU0851015	NU0851015	500	p. 187
NU0851015V	NU0851015V	500	p. 187
NU0851016	NU0851016	500	p. 187
NU0851016V	NU0851016V	500	p. 187
NU0851017	NU0851017	500	p. 187
NU0851017V	NU0851017V	500	p. 187
NU0851018	NU0851018	500	p. 187
NU0851018V	NU0851018V	500	p. 187
NU0851019	NU0851019	500	p. 187
NU0851019V	NU0851019V	500	p. 187
NU0851020	NU0851020	500	p. 187
NU0851020V	NU0851020V	500	p. 187
NU085102A	NU085102A	500	p. 187
NU085102AV	NU085102AV	500	p. 187
NU0851051	NU0851051	500	p. 187
NU0851051V	NU0851051V	500	p. 187
NU08510L1	NU08510L1	500	p. 187
NU08510L1V	NU08510L1V	500	p. 187
NU08510L2	NU08510L2	500	p. 187
NU08510L2V	NU08510L2V	500	p. 187
NU08510L3	NU08510L3	500	p. 187
NU08510L3V	NU08510L3V	500	p. 187
NU08510NI	NU08510NI	500	p. 187

TYPE	CODE	QTY. per pk.	PAGE
NU08510NIV	NU08510NIV	500	p. 187
NU08510PE	NU08510PE	500	p. 187
NU08510PEV	NU08510PEV	500	p. 187
NU08510R1	NU08510R1	500	p. 187
NU08510R1V	NU08510R1V	500	p. 187
NU08510S1	NU08510S1	500	p. 187
NU08510S1V	NU08510S1V	500	p. 187
NU08510S2	NU08510S2	500	p. 187
NU08510S2V	NU08510S2V	500	p. 187
NU08510S3	NU08510S3	500	p. 187
NU08510S3V	NU08510S3V	500	p. 187
NU08510U1	NU08510U1	500	p. 187
NU08510U1V	NU08510U1V	500	p. 187
NU08510U2	NU08510U2	500	p. 187
NU08510U2V	NU08510U2V	500	p. 187
NU08510V	NU08510V	500	p. 187
NU08510V1	NU08510V1	500	p. 187
NU08510V1V	NU08510V1V	500	p. 187
NU08510V2	NU08510V2	500	p. 187
NU08510V2V	NU08510V2V	500	p. 187
NU08510W1	NU08510W1	500	p. 187
NU08510W1V	NU08510W1V	500	p. 187
NU08510W2	NU08510W2	500	p. 187
NU08510W2V	NU08510W2V	500	p. 187
NU08511	NU08511	500	p. 187
NU085110	NU085110	500	p. 187
NU0851101	NU0851101	500	p. 187
NU0851101V	NU0851101V	500	p. 187
NU085110V	NU085110V	500	p. 187
NU085111	NU085111	500	p. 187
NU085111V	NU085111V	500	p. 187
NU085112	NU085112	500	p. 187
NU085112V	NU085112V	500	p. 187
NU085114	NU085114	500	p. 187
NU085114V	NU085114V	500	p. 187
NU085115	NU085115	500	p. 187
NU0851151	NU0851151	500	p. 187
NU0851151V	NU0851151V	500	p. 187
NU085115V	NU085115V	500	p. 187
NU08511V	NU08511V	500	p. 187
NU08512	NU08512	500	p. 187
NU0851201	NU0851201	500	p. 187
NU0851201V	NU0851201V	500	p. 187
NU0851251	NU0851251	500	p. 187
NU0851251V	NU0851251V	500	p. 187
NU08512V	NU08512V	500	p. 187
NU08513	NU08513	500	p. 187
NU0851301	NU0851301	500	p. 187

TYPE	CODE	QTY. per pk.	PAGE
NU0851301V	NU0851301V	500	p. 187
NU0851351	NU0851351	500	p. 187
NU0851351V	NU0851351V	500	p. 187
NU08513V	NU08513V	500	p. 187
NU08514	NU08514	500	p. 187
NU0851401	NU0851401	500	p. 187
NU0851401V	NU0851401V	500	p. 187
NU0851451	NU0851451	500	p. 187
NU0851451V	NU0851451V	500	p. 187
NU08514V	NU08514V	500	p. 187
NU08515	NU08515	500	p. 188
NU0851501	NU0851501	500	p. 187
NU0851501V	NU0851501V	500	p. 187
NU0851510	NU0851510	500	p. 188
NU0851510V	NU0851510V	500	p. 188
NU0851520	NU0851520	500	p. 188
NU0851520V	NU0851520V	500	p. 188
NU0851530	NU0851530	500	p. 188
NU0851530V	NU0851530V	500	p. 188
NU0851540	NU0851540	500	p. 188
NU0851540V	NU0851540V	500	p. 188
NU0851550	NU0851550	500	p. 188
NU0851550V	NU0851550V	500	p. 188
NU0851551	NU0851551	500	p. 188
NU0851551V	NU0851551V	500	p. 188
NU0851560	NU0851560	500	p. 188
NU0851560V	NU0851560V	500	p. 188
NU0851570	NU0851570	500	p. 188
NU0851570V	NU0851570V	500	p. 188
NU0851580	NU0851580	500	p. 188
NU0851580V	NU0851580V	500	p. 188
NU0851590	NU0851590	500	p. 188
NU0851590V	NU0851590V	500	p. 188
NU08515V	NU08515V	500	p. 188
NU08516	NU08516	500	p. 188
NU0851600	NU0851600	500	p. 188
NU0851600V	NU0851600V	500	p. 188
NU0851601	NU0851601	500	p. 188
NU0851601V	NU0851601V	500	p. 188
NU0851651	NU0851651	500	p. 188
NU0851651V	NU0851651V	500	p. 188
NU08516V	NU08516V	500	p. 188
NU08517	NU08517	500	p. 188
NU0851701	NU0851701	500	p. 188
NU0851701V	NU0851701V	500	p. 188
NU0851751	NU0851751	500	p. 188
NU0851751V	NU0851751V	500	p. 188
NU08517V	NU08517V	500	p. 188

TYPE	CODE	QTY. per pk.	PAGE
NU08518	NU08518	500	p. 188
NU0851801	NU0851801	500	p. 188
NU0851801V	NU0851801V	500	p. 188
NU0851851	NU0851851	500	p. 188
NU0851851V	NU0851851V	500	p. 188
NU08518V	NU08518V	500	p. 188
NU08519	NU08519	500	p. 188
NU0851901	NU0851901	500	p. 188
NU0851901V	NU0851901V	500	p. 188
NU0851951	NU0851951	500	p. 188
NU0851951V	NU0851951V	500	p. 188
NU08519V	NU08519V	500	p. 188
NU0851A	NU0851A	500	p. 188
NU0851AV	NU0851AV	500	p. 188
NU0851B	NU0851B	500	p. 188
NU0851BV	NU0851BV	500	p. 188
NU0851C	NU0851C	500	p. 188
NU0851CV	NU0851CV	500	p. 188
NU0851D	NU0851D	500	p. 188
NU0851DV	NU0851DV	500	p. 188
NU0851E	NU0851E	500	p. 188
NU0851EV	NU0851EV	500	p. 188
NU0851F	NU0851F	500	p. 188
NU0851FV	NU0851FV	500	p. 188
NU0851G	NU0851G	500	p. 188
NU0851GV	NU0851GV	500	p. 188
NU0851H	NU0851H	500	p. 188
NU0851HV	NU0851HV	500	p. 188
NU0851I	NU0851I	500	p. 188
NU0851IV	NU0851IV	500	p. 188
NU0851J	NU0851J	500	p. 188
NU0851JV	NU0851JV	500	p. 188
NU0851K	NU0851K	500	p. 188
NU0851KV	NU0851KV	500	p. 188
NU0851L	NU0851L	500	p. 188
NU0851LV	NU0851LV	500	p. 188
NU0851M	NU0851M	500	p. 188
NU0851MV	NU0851MV	500	p. 188
NU0851N	NU0851N	500	p. 188
NU0851NV	NU0851NV	500	p. 188
NU0851O	NU0851O	500	p. 188
NU0851OV	NU0851OV	500	p. 188
NU0851P	NU0851P	500	p. 188
NU0851PV	NU0851PV	500	p. 188
NU0851Q	NU0851Q	500	p. 188
NU0851QV	NU0851QV	500	p. 188
NU0851R	NU0851R	500	p. 188
NU0851RV	NU0851RV	500	p. 188

TYPE	CODE	QTY. per pk.	PAGE
NU0851S	NU0851S	500	p. 187
NU0851S	NU0851S	500	p. 187
NU0851S	NU0851S	500	p. 187
NU0851SP	NU0851SP	500	p. 189
NU0851SV	NU0851SV	500	p. 188
NU0851T	NU0851T	500	p. 188
NU0851TV	NU0851TV	500	p. 188
NU0851U	NU0851U	500	p. 188
NU0851UV	NU0851UV	500	p. 188
NU0851V	NU0851V	500	p. 188
NU0851VV	NU0851VV	500	p. 188
NU0851W	NU0851W	500	p. 188
NU0851WV	NU0851WV	500	p. 188
NU0851X	NU0851X	500	p. 188
NU0851XV	NU0851XV	500	p. 188
NU0851Y	NU0851Y	500	p. 188
NU0851YV	NU0851YV	500	p. 188
NU0851Z	NU0851Z	500	p. 188
NU0851ZV	NU0851ZV	500	p. 188
NU0861SP	NU0861SP	400	p. 189
NU1051SP	NU1051SP	500	p. 189
NU1055SP	NU1055SP	450	p. 189
NU1061SP	NU1061SP	400	p. 189
NU1065SP	NU1065SP	400	p. 189
NUL1061	NUL1061SP		p. 189
NUPUTUK50SP	NUPUTUK50SP		p. 189
NUT12SP	NUT12SP	300	p. 190
NUT12YSP	NUT12YSP		p. 190
NUT15SP	NUT15SP	400	p. 190
NUT15YSP	NUT15YSP		p. 190
NUT18SP	NUT18SP		p. 190
NUT18YSP	NUT18YSP		p. 190
NUT23SP	NUT23SP		p. 190
NUT23YSP	NUT23YSP		p. 190
NUWDK50SP	NUWDK50SP		p. 189
NUWDU50SP	NUWDU50SP	500	p. 189
NUWG051SP	NUWG051SP		p. 189
PDF.2	PF100	75	p. 124
PDF.2/GR	PF100GR	75	p. 124
PDF/PT	PF101	25	p. 152
PIL/2	PIL02	15	p. 160
PIL/3	PIL03	15	p. 160
PIL/4	PIL04	15	p. 160
PIL/8	PIL08	10	p. 160
PM/10/10	PM100	10	p. 160
PM/10/2	PM102	25	p. 160
PM/10/3	PM103	25	p. 160
PM/10/5	PM105	25	p. 160

P

TYPE	CODE	QTY. per pk.	PAGE
PM/11/10	PM110	10	p. 160
PM/11/2	PM112	25	p. 160
PM/11/3	PM113	25	p. 160
PM/11/5	PM115	25	p. 160
PM/12/10	PM120	10	p. 160
PM/12/2	PM122	25	p. 160
PM/12/3	PM123	25	p. 160
PM/12/5	PM125	25	p. 160
PM/20/10	PM210	10	p. 160
PM/20/2	PM202	25	p. 160
PM/20/3	PM203	25	p. 160
PM/20/5	PM205	25	p. 160
PM/25/10	PM250	10	p. 160
PM/25/2	PM252	25	p. 160
PM/25/3	PM253	25	p. 160
PM/25/5	PM255	25	p. 160
PM/30/10	PM310	10	p. 160
PM/30/3	PM303	25	p. 160
PM/30/5	PM305	25	p. 160
PM/40/10	PM400	10	p. 160
PM/40/2	PM402	25	p. 160
PM/40/3	PM403	25	p. 160
PM/40/5	PM405	25	p. 160
PM/41/2	PM412	25	p. 160
PM/51/10	PM510	10	p. 160
PM/51/3	PM513	25	p. 160
PM/51/5	PM515	25	p. 160
PM/60/10	PM610	10	p. 160
PM/60/2	PM602	25	p. 160
PM/60/3	PM603	25	p. 160
PM/60/5	PM605	25	p. 160
PMP/01	PMP01	8	p. 167
PMP/02	PMP02	8	p. 167
PMP/04	PMP04	8	p. 167
PMP/05	PMP05	8	p. 167
PMP/06	PMP06	8	p. 167
PMP/07	PMP07	8	p. 167
PMP/08	PMP08	8	p. 167
PMP/13	PMP13	8	p. 167
PMP/16	PMP16	8	p. 167
PMP/25	PMP25	8	p. 167
PMP/35	PMP35	8	p. 167
PMP/42	PMP42	8	p. 167
PMP/56	PMP56	8	p. 167
PMP/58	PMP58	8	p. 167
POF/06	POF06	15	p. 166
POF/07	POF07	15	p. 166
POF/08	POF08	15	p. 166

TYPE	CODE	QTY. per pk.	PAGE
POF/150/2	PO162	10	p. 166
POF/150/3	PO163	10	p. 166
POF/240/2	PO242	10	p. 166
POF/240/3	PO243	10	p. 166
POF/35	POF35	15	p. 166
POF/44	POF44	25	p. 166
POF/53	POF53	25	p. 166
POF/56	POF56	25	p. 166
POF/57	POF57	25	p. 166
POF/70	POF70	25	p. 166
POF/95/2	PO952	10	p. 166
POF/95/3	PO953	10	p. 166
POLM.1215	QPOL1203	10	p. 144
POLM.1215/BLU	QPOL1205	10	p. 144
POLM.1215/TE	QPOL1204	10	p. 144
POS/08	POS08	15	p. 168
POS/11	POS11	25	p. 168
POS/41	POS41	25	p. 168
POS/42	POS42	25	p. 168
POS/43	POS43	25	p. 168
POS/44	POS44	25	p. 168
POS/53	POS53	15	p. 168
POS/66	POS66	25	p. 168
POS/72	POS72	25	p. 168
POS/77	POS77	25	p. 168
POS/93	POS93	25	p. 168
PR/2/AC	PR009	100	p. 155
PR/2/AC/ZB	PR909	100	p. 155
PR/2/AS	PR010	100	p. 155
PR/2/AS/ZB	PR910	100	p. 155
PR/3/AC	PR003	40	p. 155
PR/3/AC/ZB	PR903	40	p. 155
PR/3/AS	PR005	40	p. 155
PR/3/AS/ZB	PR905	40	p. 155
PR/3/PA	PR006	20	p. 155
PR/3/PA/ZB	PR906	20	p. 155
PR/3/PP	PR007	20	p. 155
PR/3/PP/ZB	PR907	20	p. 155
PR/DIN/AC	PR001	20	p. 155
PR/DIN/AC/ZB	PR901	20	p. 155
PR/DIN/AL	PR002	20	p. 155
PR/DIN/AS	PR004	20	p. 155
PR/DIN/AS/ZB	PR904	20	p. 155
PRP/7/G	PRP070G	10	p. 177
PSD/A	PD001	50	p. 170
PSD/B	PD002	50	p. 170
PSD/C	PD003	50	p. 170
PSD/D	PD004	50	p. 170

TYPE	CODE	QTY. per pk.	PAGE
PSD/J	PD014	50	p. 170
PSD/K	PD011	50	p. 170
PSD/L	PD009	50	p. 170
PSD/N	PD013	50	p. 170
PSD/O	PD017	50	p. 170
PSD/P	PD015	50	p. 170
PTC/1/00	PTC0100	8	p. 161
PTC/1/02	PTC0102	25	p. 161
PTC/1/03	PTC0103	25	p. 161
PTC/1/05	PTC0105	25	p. 161
PTC/1/10	PTC0110	10	p. 161
PTC/10/00	PTC1000	8	p. 161
PTC/10/02	PTC1002	25	p. 161
PTC/10/03	PTC1003	25	p. 161
PTC/10/05	PTC1005	25	p. 161
PTC/10/10	PTC1010	10	p. 161
PTC/11/00	PTC1100	8	p. 161
PTC/11/02	PTC1102	25	p. 161
PTC/11/03	PTC1103	25	p. 161
PTC/11/05	PTC1105	25	p. 161
PTC/11/10	PTC1110	10	p. 161
PTC/16/00	PTC1600	8	p. 161
PTC/16/02	PTC1602	25	p. 161
PTC/16/03	PTC1603	25	p. 161
PTC/16/05	PTC1605	25	p. 161
PTC/16/10	PTC1610	10	p. 161
PTC/2/00	PTC0200	8	p. 161
PTC/2/02	PTC0202	25	p. 161
PTC/2/03	PTC0203	25	p. 161
PTC/2/05	PTC0205	25	p. 161
PTC/2/10	PTC0210	10	p. 161
PTC/20/00	PTC2000	8	p. 161
PTC/20/02	PTC2002	25	p. 161
PTC/20/03	PTC2003	25	p. 161
PTC/20/05	PTC2005	25	p. 161
PTC/20/10	PTC2010	10	p. 161
PTC/3/00	PTC0300	8	p. 161
PTC/3/02	PTC0302	25	p. 161
PTC/3/03	PTC0303	25	p. 161
PTC/3/05	PTC0305	25	p. 161
PTC/3/10	PTC0310	10	p. 161
PTC/4/00	PTC0400	8	p. 161
PTC/4/02	PTC0402	25	p. 161
PTC/4/03	PTC0403	25	p. 161
PTC/4/05	PTC0405	25	p. 161
PTC/4/10	PTC0410	10	p. 161
PTC/5/00	PTC0500	8	p. 161
PTC/5/02	PTC0502	25	p. 161

TYPE	CODE	QTY. per pk.	PAGE
PTC/5/03	PTC0503	25	p. 161
PTC/5/05	PTC0505	25	p. 161
PTC/5/10	PTC0510	10	p. 161
PTC/6/00	PTC0600	8	p. 161
PTC/6/02	PTC0602	25	p. 161
PTC/6/03	PTC0603	25	p. 161
PTC/6/05	PTC0605	25	p. 161
PTC/6/10	PTC0610	10	p. 161
PTC/8/00	PTC0800	8	p. 161
PTC/8/02	PTC0802	25	p. 161
PTC/8/03	PTC0803	25	p. 161
PTC/8/05	PTC0805	25	p. 161
PTC/8/10	PTC0810	10	p. 161
PTM	PTM	15	p. 154
PTMS	PTMS	36	p. 154
PTP/2/02/B	PTP0202B	25	p. 163
PTP/2/02/R	PTP0202R	25	p. 163
PTP/2/03/B	PTP0203B	25	p. 163
PTP/2/03/R	PTP0203R	25	p. 163
PTP/2/05/B	PTP0205B	25	p. 163
PTP/2/05/R	PTP0205R	25	p. 163
PTP/2/10/B	PTP0210B	25	p. 163
PTP/2/10/R	PTP0210R	25	p. 163
PTP/2/30/B	PTP0230B	25	p. 163
PTP/2/30/R	PTP0230R	25	p. 163
PTP/3/02/B	PTP0302B	25	p. 163
PTP/3/02/R	PTP0302R	25	p. 163
PTP/3/03/B	PTP0303B	25	p. 163
PTP/3/03/R	PTP0303R	25	p. 163
PTP/3/05/B	PTP0305B	25	p. 163
PTP/3/05/R	PTP0305R	25	p. 163
PTP/3/10/B	PTP0310B	25	p. 163
PTP/3/10/R	PTP0310R	25	p. 163
PTP/3/30/B	PTP0330B	25	p. 163
PTP/3/30/R	PTP0330R	25	p. 163
PTP/4/02/B	PTP0402B	25	p. 163
PTP/4/02/R	PTP0402R	25	p. 163
PTP/4/03/B	PTP0403B	25	p. 163
PTP/4/03/R	PTP0403R	25	p. 163
PTP/4/05/B	PTP0405B	25	p. 163
PTP/4/05/R	PTP0405R	25	p. 163
PTP/4/10/B	PTP0410B	25	p. 163
PTP/4/10/R	PTP0410R	25	p. 163
PTP/4/30/B	PTP0430B	25	p. 163
PTP/4/30/R	PTP0430R	25	p. 163
PTP/5/02/B	PTP0502B	25	p. 163
PTP/5/02/R	PTP0502R	25	p. 163
PTP/5/03/B	PTP0503B	25	p. 163

TYPE	CODE	QTY. per pk.	PAGE
PTP/5/03/R	PTP0503R	25	p. 163
PTP/5/05/B	PTP0505B	25	p. 163
PTP/5/05/R	PTP0505R	25	p. 163
PTP/5/10/B	PTP0510B	25	p. 163
PTP/5/10/R	PTP0510R	25	p. 163
PTP/5/30/B	PTP0530B	25	p. 163
PTP/5/30/R	PTP0530R	25	p. 163
Q QBLOK.12/BLU	QBLOK1201	10	p. 137
QBLOK.12/GR	QBLOK1203	10	p. 137
QBLOK.12/TE	QBLOK1202	10	p. 137
QBLOK.7/BLU	QBLOK7001	10	p. 137
QBLOK.7/GR	QBLOK7003	10	p. 137
QBLOK.7/TE	QBLOK7002	10	p. 137
QBLOK1P080A07E	QBLOK1P080E		p. 145
QBLOK1P125A08E	QBLOK1P125E		p. 145
QBLOK1P160A08E	QBLOK1P160E		p. 145
QBLOK1P160A6	QBLOK1P160	1	p. 138
QBLOK1P250A10	QBLOK1P250	1	p. 138
QBLOK1P250A12E	QBLOK1P250E		p. 146
QBLOK1P400A10	QBLOK1P400	1	p. 138
QBLOK1P400A12E	QBLOK1P400E		p. 146
QBLOK1P500A12E	QBLOK1P500E		p. 146
QBLOK2P100A7	QBLOK2100	4	p. 141
QBLOK2P125A11	QBLOK2125	2	p. 141
QBLOK2P125A15	QBLOK2126	2	p. 141
QBLOK4P100A7	QBLOK4100	2	p. 142
QBLOK4P125A11	QBLOK4125	1	p. 142
QBLOK4P125A15	QBLOK4126	1	p. 142
QBLOK4P160A14	QBLOK4161N	1	p. 143
QBLOK4P160A9	QBLOK4160S	1	p. 143
R RFN/PT[Ex]i	RF201	25	p. 152
RFN/PT/GR	RF101GR	25	p. 152
RN.1 [EX]I	RN400	125	p. 129
RN.1/GR	RN300GR	125	p. 129
RN.2 [EX]I	RN510	110	p. 129
RN.2/GR	RN500GR	110	p. 129
RP.4 [EX]I	RP400	200	p. 129
RP.4/GR	RP300GR	200	p. 129
RP.4/PT[Ex]i	RP401	25	p. 152
S RP.4/PT/GR	RP301GR	25	p. 152
SCB.10	SB400	80	p. 111
SCB.10/CD	SB420	80	p. 111
SCB.10/CD/GR	SB420GR	80	p. 111
SCB.10/DD	SB410	80	p. 111
SCB.10/DD/GR	SB410GR	80	p. 111
SCB.10/GR	SB400GR	80	p. 111
SCB.4	SB300	75	p. 108
SCB.4/GR	SB300GR	75	p. 108

TYPE	CODE	QTY. per pk.	PAGE
SCB.6	SB200	100	p. 110
SCB.6/CD	SB220	80	p. 110
SCB.6/CD/GR	SB220GR	80	p. 110
SCB.6/DD	SB210	80	p. 110
SCB.6/DD/GR	SB210GR	80	p. 110
SCB.6/GR	SB200GR	100	p. 110
SCB/10/P/GR	SB401GR	25	p. 152
SCB/10/PT	SB401	25	p. 152
SCB/4/CPM	SB305	25	p. 172
SCB/4/PO/2	SB303	40	p. 172
SCB/4/PO/4	SB304	20	p. 172
SCB/4/PT	SB301	25	p. 152
SCB/4/PT/GR	SB301GR	25	p. 152
SCB/6/CPM	SB205	25	p. 172
SCB/6/PO/2	SB203	40	p. 172
SCB/6/PO/4	SB204	20	p. 172
SCB/6/PT	SB201	25	p. 152
SCB/6/PT/GR	SB201GR	25	p. 152
SCX/CPM	SC105	40	p. 172
SCX/PO/2	SC103	40	p. 172
SCX/PO/4	SC104	20	p. 172
SD5/PT	DD501	25	p. 169
SD6/PT	DD601	25	p. 169
SDC/5	DC005	25	p. 169
SDC/5P	DC05P	25	p. 169
SDC/6	DC006	25	p. 169
SDC/6P	DC06P	25	p. 169
SDD/1	DD001	50	p. 170
SDD/2	DD002	50	p. 170
SDD/5	DD005	25	p. 169
SDD/6	DD006	25	p. 169
SDH/4	DH004	25	p. 169
SDH/5	DH005	25	p. 169
SDH/6	DH006	25	p. 169
SDH/7	DH007	25	p. 169
SFC/CO	FC102	70	p. 172
SFO/PT	SF401	25	p. 152
SFO/PT [Ex]i	SF601	25	p. 152
SFO/PT/GR	SF401GR	25	p. 152
SFR.4	SF900	70	p. 97
SFR.4	SF900	70	p. 97
SFR.4	SF900	70	p. 97
SFR.4 [EX]I	SF850	70	p. 97
SFR.4 [EX]I	SF850	70	p. 97
SFR.4/C230	SF923	70	p. 103
SFR.4/C230/GR	SF923GR	70	p. 103
SFR.4/C48	SF948	70	p. 103
SFR.4/C48/GR	SF948GR	70	p. 103

TYPE	CODE	QTY. per pk.	PAGE
SFR.4/D1	SFR901	70	p. 112
SFR.4/D1/GR	SF901GR	70	p. 112
SFR.4/D3	SFR903	70	p. 112
SFR.4/D3/GR	SF903GR	70	p. 112
SFR.4/GR	SF900GR	70	p. 97
SFR.4/GR	SF900GR	70	p. 97
SFR.4/GR	SF900GR	70	p. 97
SFR.4/GR	SF900GR	70	p. 97
SFR.4/VS	SF910	50	p. 99
SFR.4/VS	SF910	50	p. 99
SFR.4/VS/GR	SF910GR	50	p. 99
SFR.4/VS/GR	SF910GR	50	p. 99
SFR.6	SR300	50	p. 98
SFR.6	SR300	50	p. 98
SFR.6 [EX]I	SR400	50	p. 98
SFR.6 [EX]I	SR400	50	p. 98
SFR.6/GR	SR300GR	50	p. 98
SFR.6/GR	SR300GR	50	p. 98
SFR.6/M	SR500	50	p. 98
SFR.6/M	SR500	50	p. 98
SFR.6/M [EX]I	SR600	50	p. 98
SFR.6/M [EX]I	SR600	50	p. 98
SFR.6/M/GR	SR500GR	50	p. 98
SFR.6/M/GR	SR500GR	50	p. 98
SFR.6/PT	SR301	25	p. 152
SFR.6/PT[Ex]i	SR401	25	p. 152
SFR/PT	SF701	25	p. 152
SFR/PT [Ex]i	SF801	25	p. 152
SH004SP	SH004SP	500	p. 189
SH2.1	SH004S	1500	p. 189
SH4/PT	DH401	25	p. 169
SH5/PT	DH501	25	p. 169
SH6/PT	DH601	25	p. 169
SH7/PT	DH701	25	p. 169
SNZ/4/00	SN008	60	p. 189
T SNZ/4/SP	SN004SP	60	p. 189
TC/PO	TC500	125	p. 127
TC/PO [EX]I	TC510	125	p. 127
TC/PO/GR	TC500GR	125	p. 127
TDE.2	TL500	125	p. 96
TDE.2/GR	TL500GR	125	p. 96
TE.10/D	TE500	35	p. 89
TE.10/O	T0500	35	p. 87
TE.16/D	TE210	30	p. 89
TE.16/O	T0210	30	p. 88
TE.50/D	TE310	15	p. 89
TE.50/O	T0310	15	p. 88
TE.6/D	TE110	50	p. 88
TE.6/O	T0110	45	p. 87

TYPE	CODE	QTY. per pk.	PAGE	TYPE	CODE	QTY. per pk.	PAGE
TEC.10/O	T0510	35	p. 62	WP100-28	WP30025	500	p. 180
TEC.16/O	T0220	30	p. 62	WP15-14	WP30013	500	p. 180
TEC.35/O	T0320	15	p. 63	WP15-18	WP30014	500	p. 180
TEC.6/O	T0120	45	p. 62	WP160-22	WP30026	100	p. 180
TEC.70/O	T0810	25	p. 63	WP160-28	WP30027	500	p. 180
TE0.4	TE400	65	p. 87	WP25-14	WP30016	500	p. 180
TE0.2	T0910	75	p. 86	WP25-19	WP30017	500	p. 180
TE0.2/PT	T0901	50	p. 152	WP250-29	WP30028	50	p. 180
TE0.4	T0430	50	p. 86	WP250-32	WP30029	500	p. 180
TE0.4/PT	T0431	25	p. 152	WP350-30	WP30030	50	p. 180
TH/2	TH02	50	p. 178	WP350-41	WP30031	500	p. 180
TH/3	TH03	50	p. 178	WP40-16	WP30019	500	p. 180
TLD.2	TL200	125	p. 96	WP40-20	WP30020	500	p. 180
TLD.2 (EX)I	TL300	125	p. 96	WP5-14	WP30002	500	p. 180
TLD.2/GR	TL200GR	125	p. 96	WP5-16	WP30003	500	p. 180
TLD/PT	TL201	25	p. 152	WP500-40	WP30032	50	p. 180
TLD/PT (Ex)I	TL301	25	p. 152	WP500-41	WP30033	500	p. 180
TLE.2	TL400	200	p. 96	WP60-20	WP30022	100	p. 180
TLE.2/GR	TL400GR	200	p. 96	WP60-26	WP30023	500	p. 180
TLS.2	TL100	200	p. 95	WP75-14	WP30005	500	p. 180
TLS.2/GR	TL100GR	200	p. 95	WP75-16	WP30006	500	p. 180
TLS/PT	TL101	25	p. 152	WPD01/15	WP90003	500	p. 181
TLS/PT/GR	TL201GR	25	p. 152	WPD04/23	WP90006	500	p. 181
TPL.4	TP100	40	p. 131	WPD05/15	WP90001	500	p. 181
TPL.4/PS	TP200	40	p. 132	WPD15/16	WP90004	500	p. 181
TR.2	TR110	100	p. 130	WPD25/18	WP90005	500	p. 181
TR.2/PT	TR111	25	p. 152	WPD75/15	WP90002	500	p. 181
TR.4	TR200	50	p. 130	WPN0508	WPN10508	1000	p. 181
TTM/04	TTM04	10	p. 177	WPN0758	WPN10758	1000	p. 181
TTM/12	TTM12	10	p. 177	WPN1010	WPN11010	1000	p. 181
TTM/15	TTM15	10	p. 177	WPN1015	WPN11015	500	p. 181
TUM/05	TUM05	10	p. 177	WPN1510	WPN11510	1000	p. 181
TUM/06	TUM06	10	p. 177	WPN1615	WPN11615	1000	p. 181
TUM/07	TUM07	10	p. 177	WPN2510	WPN12510	1000	p. 181
TUM/08	TUM08	10	p. 177	WPN2515	WPN12515	250	p. 181
TUM/16	TUM16	10	p. 177	WPN4012	WPN14012	1000	p. 181
VPC.2 (EX)I	VP310	120	p. 125	WPN6012	WPN16012	500	p. 181
VPC.2/GR	VP300GR	120	p. 125				
VPC/PT	VP101	25	p. 152				
VPC/PT (Ex)I	VP201	25	p. 152				
VPC/PT/GR	VP101GR	25	p. 152				
VPD.2 (EX)I	VP560	40	p. 126				
VPD.2/GR	VP500GR	40	p. 126				
VPD/PT(Ex)I	VP561	25	p. 152				
VPD/PT/GR	VP501GR	25	p. 152				
WP1-14	WP30009	500	p. 180				
WP1-18	WP30010	500	p. 180				
WP100-21	WP30024	100	p. 180				

15 horizontal grey bars for taking notes.

Blank lined area for notes.

Blank lined area for notes.



AUTOMATION
AND CONTROL
SOLUTIONS



INDUSTRIAL
CONNECTIVITY
SOLUTIONS



SOLUTIONS
FOR RENEWABLE
ENERGY



INDUSTRIAL
MARKING
SOLUTIONS



D011G22A - 0822

Cabur Srl

Headquarters (Italia)

17041 - Altare (SV)

Località Isola Grande, 45

T. +39 019 58999.1

F. +39 019 58999233

www.cabur.it

info@cabur.it

Cabur Romania Srl

Subsidiary

Strada Calea Plevnei nr. 139

Corp B camera 25,26 sector 6

Bucaresti

T. +40 (21)31.17.140

F. +40 (21)31.17.140

www.cabur.eu

info.romania@cabur.eu