

WIRELESS

2022

Wireless Index



Main features pag. 4



Wireless pushbuttons pag. 6

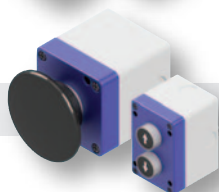

Wireless control stations pag. 7

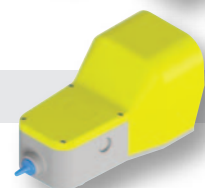

Wireless foot switches pag. 11



Wireless limit switches pag. 12



Wireless rope switches pag. 13



Receivers and accessories pag. 14



Instructions for use pag. 15

Wireless

Main features

APPROVALS:



DIRECTIVES AND REGULATIONS:

RED 2014/53/EU
FCC Part 15B
ICES-003

COMEPI wireless batteryless devices. The new series of wireless controls designed to be complete, flexible and sustainable. The modular wireless transmitter is adaptable to most COMEPI electromechanical devices. This guarantees product flexibility, also thanks to the wireless connection that makes life easier for operators and designers. The transmission technology, built on the ENOCEAN protocol, uses the kinetic energy of the implementation to create the energy needed to transmit information to the receiver. The absence of batteries makes the product sustainable and reduces maintenance costs.

SIMPLICITY

- Quick and easy installation
- Quick setup
- Absence of cables on transmitters
- Freedom of movement while using the device
- Reduced installation times and costs

SUSTAINABILITY

- No battery to replace, dispose or recharge
- Minimized energy consumption
- Environmental impact of the plant greatly reduced
- No maintenance required

RELIABILITY

- High degree of protection
- No risk of damage to cables
- High mechanical durability
- Efficient and certified transmission

FLEXIBILITY

- Suitable for multiple applications and work environments
- Modular construction allows to create customizations to the product
- Possibility to modify the configuration at any time in a short time
- Ideal in dynamic situations and in constant change

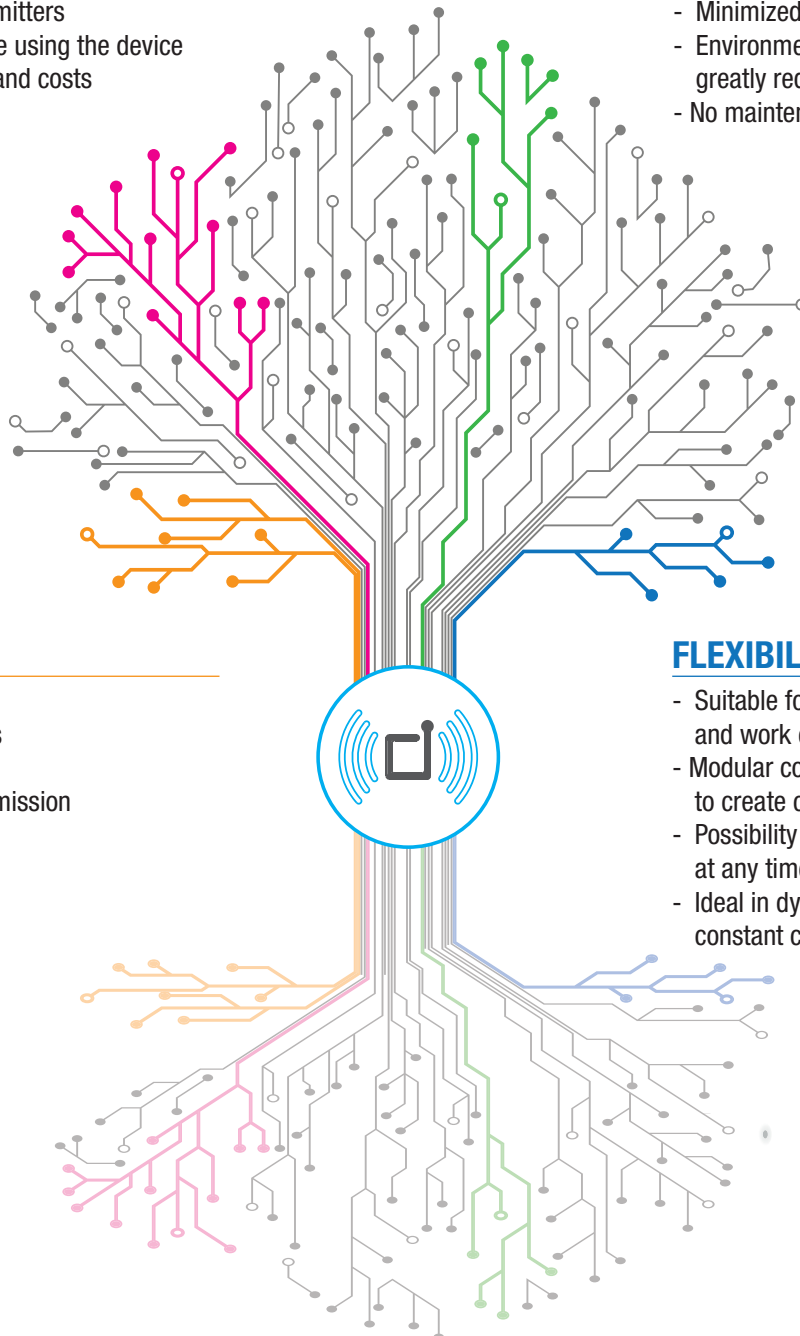

Wireless

Batteryless transmitters

APPROVALS:



DIRECTIVES AND REGULATIONS:

RED 2014/53/UE
FCC Part 15B
ICES-003

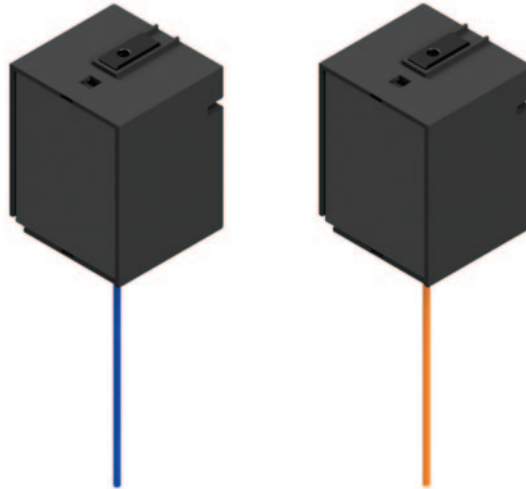

DESCRIPTION / MAIN FEATURES

Microswitches with wireless technology without battery, modular solution suitable for all wireless devices produced by COMEPI. ENOCEAN communication protocol - Operating frequency 868MHz and 902MHz.

SIMPLICITY:

- Reduced costs and installation times
- Quick set-up and configuration
- Absence of cables and wiring on transmitters
- Freedom of movement while using the device.

SUSTAINABILITY:

- No batteries to replace, dispose of or recycle
- Immediate availability of the necessary energy
- Minimized energy consumption.

FLEXIBILITY:

- Suitable for any type of application
- Modular construction
- Fully configurable
- Greater comfort for the operator

RELIABILITY:

- High degree of protection
- No risk of damage to cables
- Mechanical durability and level reliability

Code

RFH8 Modular transmitter for batteryless wireless devices - Operating frequency 868MHz
RFH9 Modular transmitter for batteryless wireless devices - Operating frequency 902MHz

Wireless

Wireless Batteryless Pushbuttons

APPROVALS:



DIRECTIVES AND REGULATIONS:

RED 2014/53/UE
FCC Part 15B
ICES-003

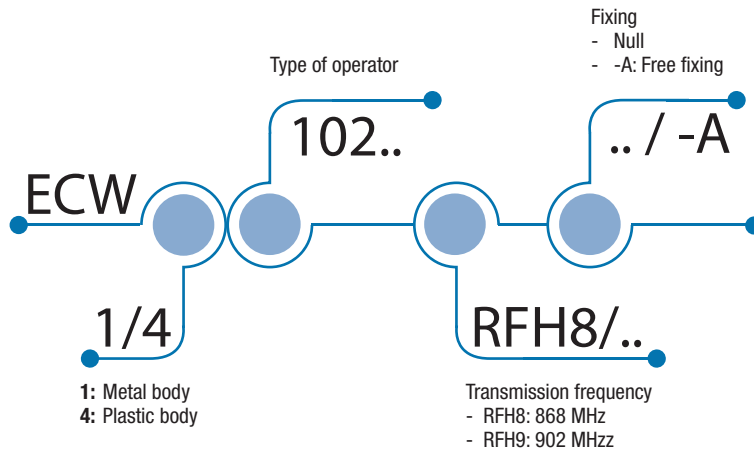

HOW IS IT MADE?

- 01 Plastic or metal body
- 02 Support base with integrated antenna
- 03 RFH8 or RFH9 transmitter
- 04 Version with flaps for free fixing without panel

APPLICATIONS:

- Logistics center sorting lines
- Start command for automated machines
- Start for AGV self-driving vehicles
- Automatic door opening
- Control of gates and automatic bars
- Automated production lines
- Lighting and control of lighting and devices
- Operator call button

DESCRIPTION / MAIN FEATURES

Simple and functional.

The absence of cables and the possibility of fixing on the surface make the product more flexible and make life easier for designers and operators.

COMPATIBLE OPERATORS:

- Impulsive pushbuttons
- Simple impulsive mushrooms
- Two positions selectors with return
- One position joystick with return
- Wooble joysticks and pushbutton

To choose the proper type of operator, consult our catalogue CAT139.

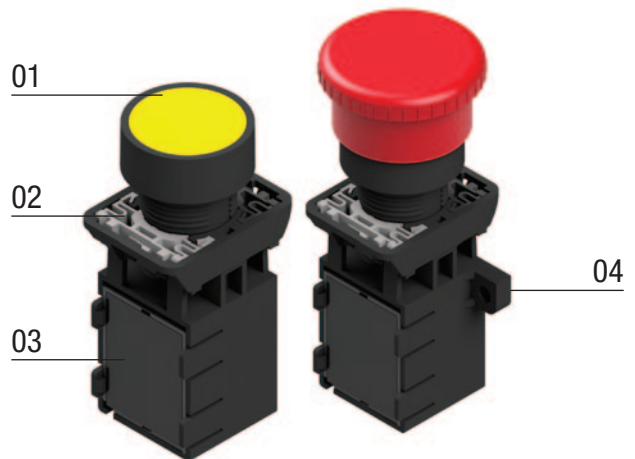

Wireless

Wireless Batteryless Control Stations

APPROVALS:



DIRECTIVES AND REGULATIONS:

RED 2014/53/UE
FCC Part 15B
ICES-003

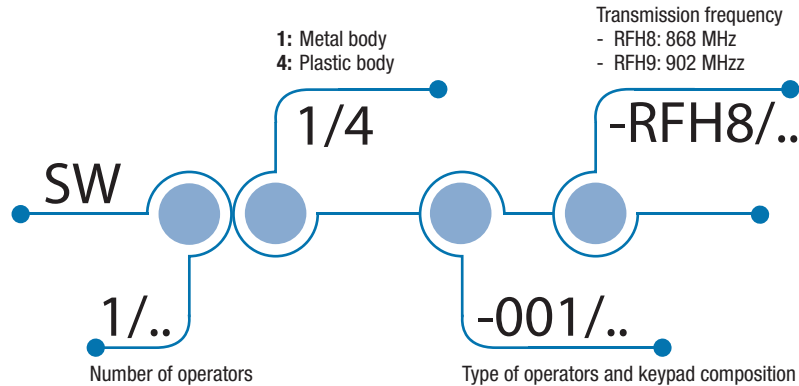

HOW IS IT MADE?

- 01 Plastic or metal operator body
- 02 Support base with integrated antenna
- 03 RFH8 or RFH9 transmitter
- 04 Shock-resistant ABS box

APPLICATIONS:

- Logistics center sorting lines
- Start command for automated machines
- Start for AGV self-driving vehicles
- Automatic door opening
- Control of gates and automatic bars
- Automated production lines
- Lighting and control of lighting and devices
- Operator call button

DESCRIPTION / MAIN FEATURES

Simple and functional.

The operator can carry the device with him, limiting movement and the associated risks. The push-button panels can be carried on forklifts to facilitate the opening of the automatic doors by the staff, speeding up loading and unloading operations.

COMPATIBLE OPERATORS:

- Impulsive pushbuttons
- Simple impulsive mushrooms
- Two positions selectors with return
- One position joystick with return
- Wooble joysticks and pushbutton

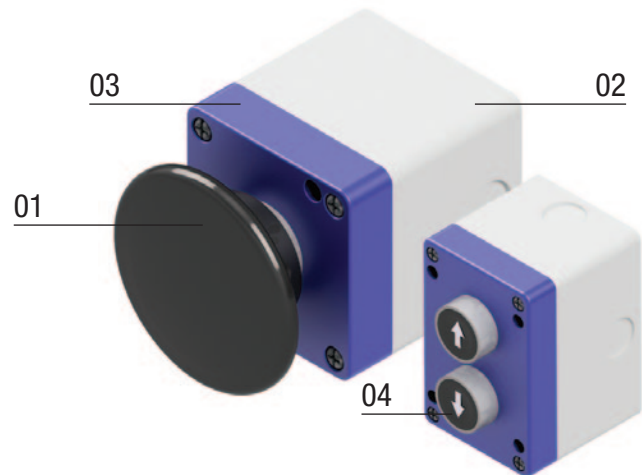

Wireless

Wireless Batteryless Control Stations

One operator - White ON pushbutton

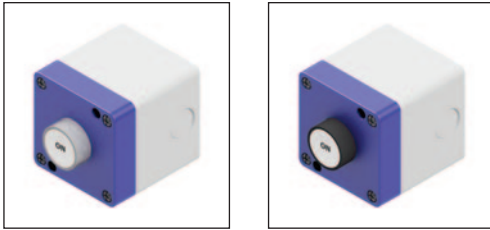

Code	Description	Frequency
SW11-001-RFH8	Chrome plated zamak body	868MHz
SW14-001-RFH8	Plastic body	868MHz
SW11-001-RFH9	Chrome plated zamak body	902MHz
SW14-001-RFH9	Plastic body	902MHz

One operator - Green START pushbutton

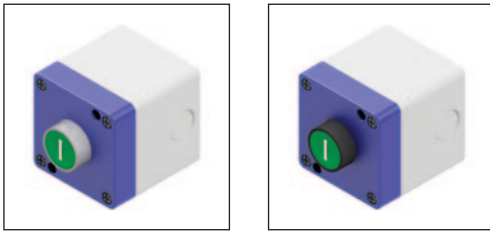

Code	Description	Frequency
SW11-002-RFH8	Chrome plated zamak body	868MHz
SW14-002-RFH8	Plastic body	868MHz
SW11-002-RFH9	Chrome plated zamak body	902MHz
SW14-002-RFH9	Plastic body	902MHz

One operator - Black 40mm mushroom pushbutton without latch

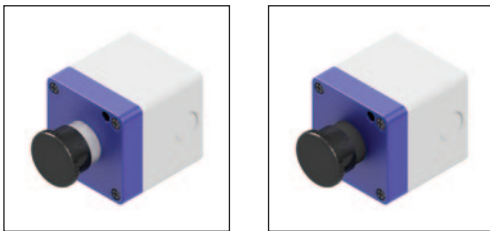

Code	Description	Frequency
SW11-003-RFH8	Chrome plated zamak body	868MHz
SW14-003-RFH8	Plastic body	868MHz
SW11-003-RFH9	Chrome plated zamak body	902MHz
SW14-003-RFH9	Plastic body	902MHz

One operator - Yellow 40mm mushroom pushbutton without latch

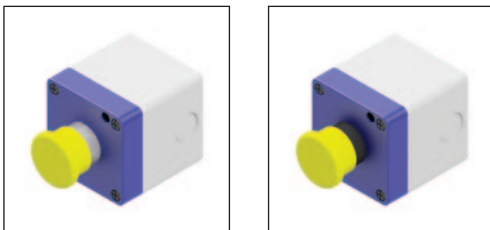

Code	Description	Frequency
SW11-004-RFH8	Chrome plated zamak body	868MHz
SW14-004-RFH8	Plastic body	868MHz
SW11-004-RFH9	Chrome plated zamak body	902MHz
SW14-004-RFH9	Plastic body	902MHz

One operator - Black 30mm mushroom pushbutton without latch

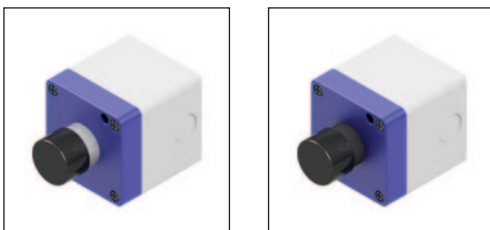

Code	Description	Frequency
SW11-005-RFH8	Chrome plated zamak body	868MHz
SW14-005-RFH8	Plastic body	868MHz
SW11-005-RFH9	Chrome plated zamak body	902MHz
SW14-005-RFH9	Plastic body	902MHz

One operator - Black 60mm mushroom pushbutton without latch

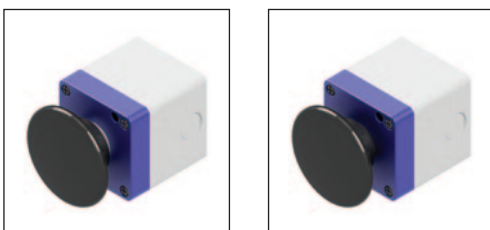

Code	Description	Frequency
SW11-006-RFH8	Chrome plated zamak body	868MHz
SW14-006-RFH8	Plastic body	868MHz
SW11-006-RFH9	Chrome plated zamak body	902MHz
SW14-006-RFH9	Plastic body	902MHz

Wireless

Wireless Batteryless Control Stations

One operator - Two positions selector switch 0-1 maintained

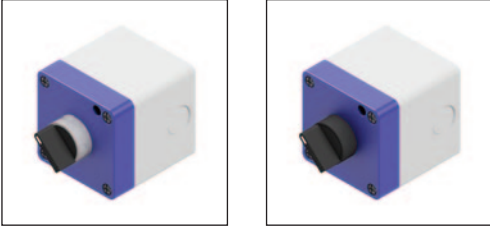

Code	Description	Frequency
SW11-007-RFH8	Chrome plated zamak body	868MHz
SW14-007-RFH8	Plastic body	868MHz
SW11-007-RFH9	Chrome plated zamak body	902MHz
SW14-007-RFH9	Plastic body	902MHz

One operator - Two positions selector switch with key 0-1 maintained

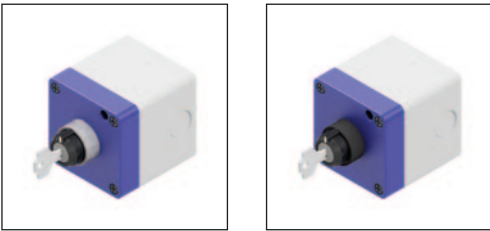

Code	Description	Frequency
SW11-008-RFH8	Chrome plated zamak body	868MHz
SW14-008-RFH8	Plastic body	868MHz
SW11-008-RFH9	Chrome plated zamak body	902MHz
SW14-008-RFH9	Plastic body	902MHz

One operator - Joystick one positions selector switch with return

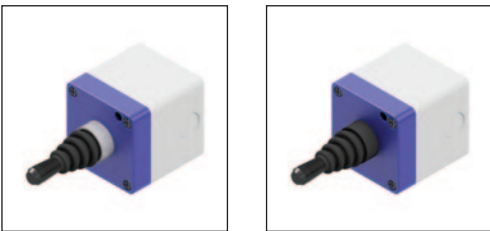

Code	Description	Frequency
SW11-009-RFH8	Chrome plated zamak body	868MHz
SW14-009-RFH8	Plastic body	868MHz
SW11-009-RFH9	Chrome plated zamak body	902MHz
SW14-009-RFH9	Plastic body	902MHz

One operator - Black extended pushbutton

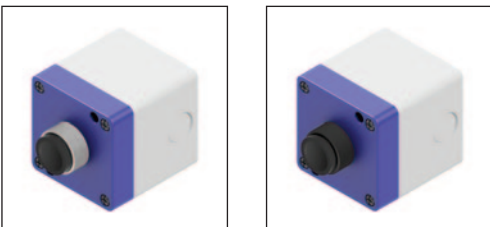

Code	Description	Frequency
SW11-010-RFH8	Chrome plated zamak body	868MHz
SW14-010-RFH8	Plastic body	868MHz
SW11-010-RFH9	Chrome plated zamak body	902MHz
SW14-010-RFH9	Plastic body	902MHz

One operator - Black 90mm wobble palm switch



Code	Description	Frequency
SW14-080-RFH8	Plastic body	868MHz
SW14-080-RFH9	Plastic body	902MHz

Wireless

Wireless Batteryless Control Stations

Two operators - UP & DOWN pushbuttons

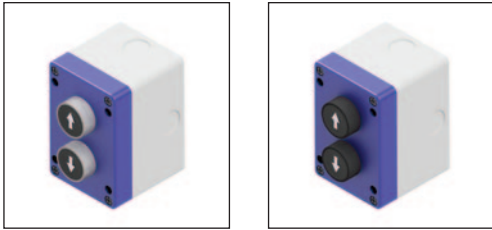

Code	Description	Frequency
SW21-001-RFH8	Chrome plated zamak body	868MHz
SW24-001-RFH8	Plastic body	868MHz
SW21-001-RFH9	Chrome plated zamak body	902MHz
SW24-001-RFH9	Plastic body	902MHz

Two operators - ON & OFF pushbuttons

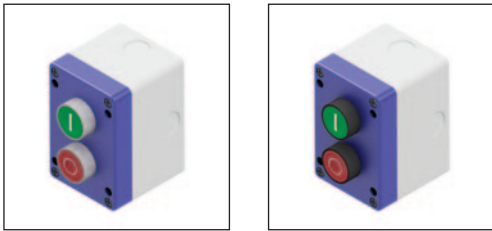

Code	Description	Frequency
SW21-002-RFH8	Chrome plated zamak body	868MHz
SW24-002-RFH8	Plastic body	868MHz
SW21-002-RFH9	Chrome plated zamak body	902MHz
SW24-002-RFH9	Plastic body	902MHz

Two operators - START & STOP pushbuttons

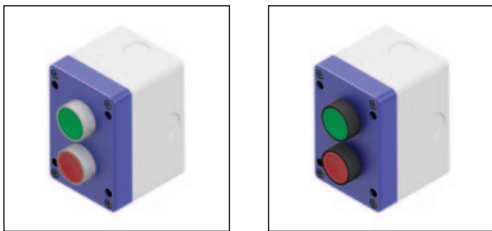

Code	Description	Frequency
SW21-003-RFH8	Chrome plated zamak body	868MHz
SW24-003-RFH8	Plastic body	868MHz
SW21-003-RFH9	Chrome plated zamak body	902MHz
SW24-003-RFH9	Plastic body	902MHz

Other control station configurations are available on request: contact our sales department.

Wireless

Wireless batteryless foot switches

APPROVALS:



DIRECTIVES AND REGULATIONS:

RED 2014/53/UE
FCC Part 15B
ICES-003

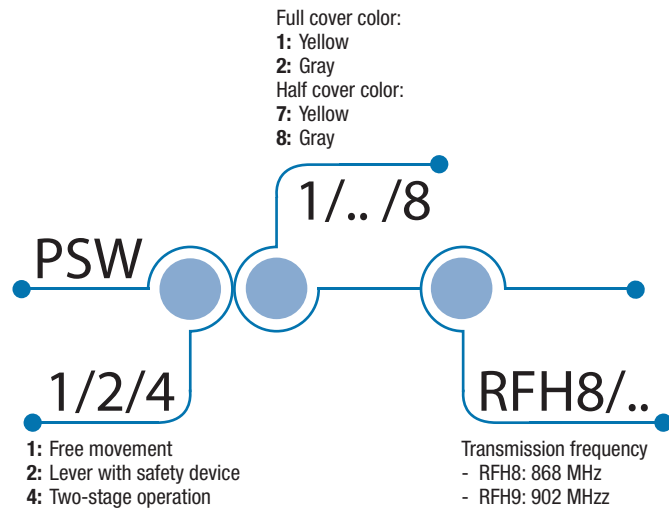

HOW IS IT MADE?

- 01 Plastic cover
- 02 Sturdy and robust construction
- 03 RFH8 or RFH9 transmitter inside
- 04 Different operating principles
- 05 Antenna

APPLICATIONS:

- Logistic plants and hubs
- Start command for automated machines
- Opening of automatic doors
- Remote command for gates and entrance barriers

DESCRIPTION / MAIN FEATURES

The foot switch can be easily moved and placed in the most comfortable position for the operator. The absence of cables and wirings minimizes the risk when moving within the working area.

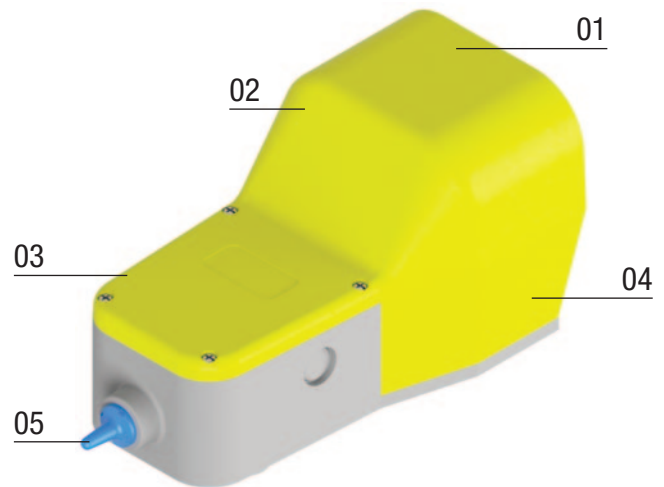

Wireless

Wireless Batteryless limit switches

APPROVALS:



DIRECTIVES AND REGULATIONS:

RED 2014/53/UE
FCC Part 15B
ICES-003

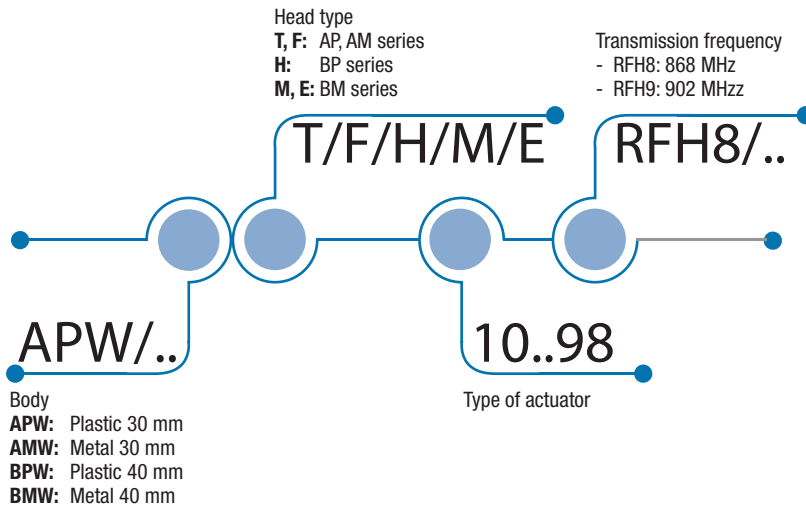

HOW IS IT MADE?

- 01 Actuating head in plastic or metal
- 02 Plastic or metal case, available in two sizes
- 03 RFH8 or RFH9 transmitter
- 04 Antenna

APPLICATIONS:

- Logistics center sorting lines
- Procurement of components in production lines
- Opening and signaling on automatic doors
- Signaling on automatic gates and doors
- Automated production lines
- Lighting and control of lighting and devices
- Count pieces or count shots

DESCRIPTION / MAIN FEATURES

Simple and functional.

The absence of wiring facilitates and makes installation operations more economical. The flexibility of the product allows unthinkable positioning in ordinary cable configurations. Can be used with all actuators available in the catalogue.

To choose the proper type of operator, consult our catalogue CAT142.

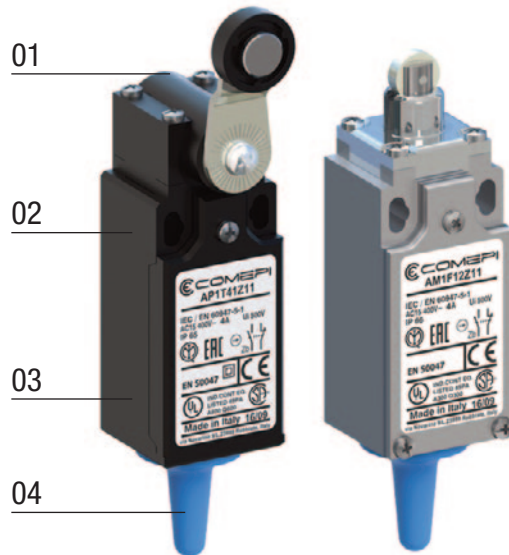

Wireless

Wireless Batteryless Rope Switches

APPROVALS:



DIRECTIVES AND REGULATIONS:

RED 2014/53/UE
FCC Part 15B
ICES-003

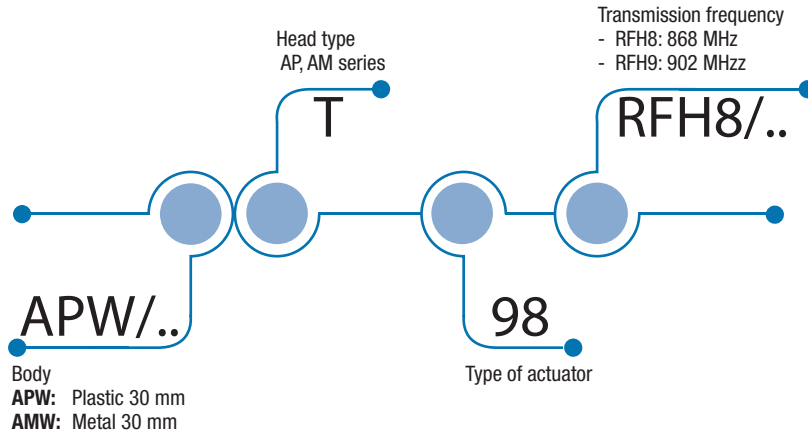

HOW IS IT MADE?

- 01 Pull action by rope
- 02 High resistance in case of strong tractions
- 03 Plastic or metal case, 30mm wide
- 04 RFH8 or RFH9 transmitter
- 05 Antenna

APPLICATIONS:

- Opening and signaling on automatic doors
- Opening of gates and automatic doors
- Start command for automated machines
- Automated production lines
- Lighting and control of lighting and devices
- Operator call device

DESCRIPTION / MAIN FEATURES

Simple and functional.

Degree of protection IP67 (plastic) or IP66 (metal).

The different modes of use available on the receiver make it possible, for example, to use the rope switch as turning on and off the lights in a production area, minimizing wiring and bypassing the use of bistable relays.

To let the switches work properly, choose the operating mode 3 or 4 on our RRH8 or RRH9 receiver.

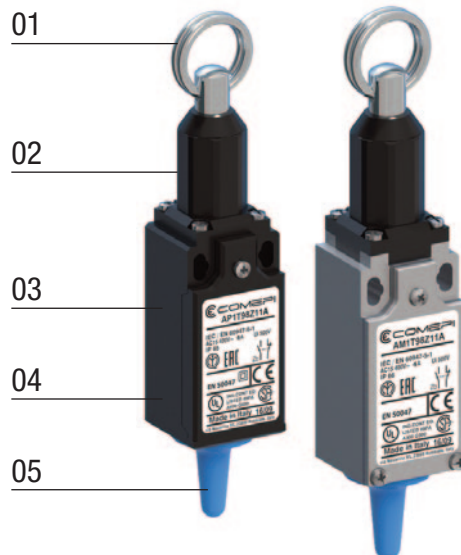

Wireless

Wireless receivers

APPROVALS:



DIRECTIVES AND REGULATIONS:

RRH8: RED 2014/53/U



DESCRIPTION / MAIN FEATURES

The RRH series receivers are suitable for managing batteryless wireless transmitters on four independent relay outputs and with five different operating modes. Reliability of transmission, simplicity of installation and flexibility of use are the elements that distinguish this product.

TWO TYPES OF RECEIVERS

- RRH8: Receiver for 868MHz devices
- RRH9: Receiver for 902MHz devices
- The fixing is carried out on a DIN bar, width two modules
- 24Vdc power supply
- Signal intensity led

DEVICE OUTPUTS

- Four independent relay outputs
- Up to 28 transmitters can be associated with each output
- Each relay can have a different control function

DEVICE PERFORMANCE:

Various types of connection:

- open field 80m
- free industrial environment 30m
- industrial environment with 20m obstacles

FIVE TYPES OF CONFIGURABLE MODES:

- 1 Impulsive mode
- 2 Maintained mode
- 3 Pulse mode in return
- 4 Mode maintained in return
- 5 Bistable mode

Code

RRH8 Receiver for COMEPI batteryless wireless devices - Operating frequency 868MHz
RRH9 Receiver for COMEPI batteryless wireless devices - Operating frequency 902MHz

Wireless

Instructions for use

(Firmware version: COMENOC 1.01)

AVAILABLE RECEIVER DEVICES

RRH8 → 868MHz receiver for wireless batteryless transmitters

RRH9 → 902MHz receiver for wireless batteryless transmitters



DEVICES IDENTIFICATION

RRH devices are equipped with a side label with all the identity information, including the device serial number. The RRH9 device is easily recognizable from the RRH8 one because of the RED color of the CONFIG button.

AVAILABLE TRANSMITTERS DEVICES

COMEPI transmitters are identified by different product series according to the complete product type and they contain one of the follow modular transmitters module:

RFH8 → 868MHz transmitters module for wireless batteryless devices

RFH9 → 902MHz transmitters module for wireless batteryless devices

TRANSMISSION PROTOCOL

The transmission between transmitter and receiver is performed with ENOCEAN communication protocol. The signal generation is made without batteries generating energy from motion during the device actuation. The transmission uses an operating frequency 868MHz for RFH8 and RRH8 devices and 902MHz for RFH9 and RRH9 devices.



DIRETTIVE E REGOLAMENTI DI RIFERIMENTO

RED Directive 2014/53/EU (RRH8) – FCC Regulation PART 15B (RRH9) – ICES-003 Regulation (RRH9) – RoHS2 Directive 2011/65/CE + UE 2015/863 Delegate Directive – REACH Regulation

VALIDATIONS AND APPROVALS

CE according to RED 2014/53/EU Directive (RRH8) → DDC25 download on www.comepi.eu

CE according to RED 2014/53/EU Directive (RFH8) → DDC24 download on www.comepi.eu

UL according to UL 508 (RRH8 and RRH9) → cULus LISTED – NKCR – E189258

FCC SDoC (RRH9) → SDoCFCC01 download on www.comepi.eu

IC SDoC (RRH9) → SDoCIC01 download on www.comepi.eu

FCC (RFH9) → Contains FCC ID SZV-PTM330U

IC (RFH9) → Contains IC ID 5713A-PTM330U

LIMIT OF USE

⚠ Do not use the device in safety applications preventing dangerous situations for people and equipment. Do not use in environment where continuous changes of temperature take place, where it is possible that condensation inside the device can be formed. Do not use in working area non compatible with the IP protection degree of the device. Do not install in presence of flammable dust or gas. Do not use up or down to the allowed operating temperature limits. Do not use in presence of corrosive chemical agents that can damage the hardware of the device. Use the device in full respect of the standards in forces. following the installation instructions and stay within the limit of use. In case of not compliant use, no respect of the instruction of use, installation and maintenance provided by unqualified people and functional tests omission, the producer is excluded from any responsibility.

ENVIRONMENTAL RATINGS

The device is design for application inside the electrical panel

EN 60529 protection degree is IP20

Air room temperature limits during operations 0°C ... +55°C

The upper temperature limit expected from UL requirements according to UL508 is +40°C

DEVICE INTERFACE AND WIRING

The device is equipped with six signaling LEDs. The PWR LED indicates the proper connection to supply voltage 24Vdc. The CH1 – CH2 – CH3 – CH4 LEDs show the current state of the relay outputs: they light up when the corresponding relay is closed. The SIGN LED gives a feedback on the received signal intensity. The device is equipped with a CONFIG button to set the operating modes and configure properly the device. The device is equipped with screw terminals to perform the conductor connections.

Min. and max. allowed conductor sections: 0,14mm² ... 2.5mm²

Conductor stripping or cable terminal length: 7mm

⚠ Before the wiring operations be sure that the supply voltage is off on the device. At the end of wiring verify that the terminals are free from external contaminating objects and that all the connected wires are firmly fixed to the terminals. During and after installation be sure to don't pull down the wired conductors. If improper tractions are applied on the device some dangerous damages can happen.

⚠ Before putting the device on service verify that the supply values are suitable with the ones here reported: 24Vdc (-15%...+10%) – Max 0,5A

DEVICE OUTPUTS

RRH8 and RRH9 receivers are equipped with four independent relay outputs. A single transmitter can be associated to more outputs and the same output can manage more than one associated transmitter. The output contact is an electromechanical relay in NO configurations, with following electrical rated values: $U_i = 250V$ – $U_e/I_e = 250Vac/3A$ – $U_{imp} = 2,5kV$ – Utilization Categories AC-15 DC-13 according to EN 60947-5-1

Category of use according to UL508 = CLASS II – Overvoltage Category III

POWER-ON PROCEDURE

Power up the device, when the supply voltage is correctly give CH1 – CH2 – CH3 – CH4 LEDs light up. Their shutdown signal that the device is ready to be used in operating mode.

Supply voltage: 24Vdc (-15%...+10%)

Use only a supply voltage given by a 24Vdc power supply conform to the reference Directives. Do not connect directly to the main power supply.

DEVICE PRE-SET

To be used at first device use and in case of complete reset needed

1. Perform the power-on procedure.
2. Press and hold the CONFIG button for a time higher than 15s.
3. Three simultaneous flashes of CH1 – CH2 – CH3 – CH4 LEDS signal that the pre-set procedure was correctly done and the device is reset.
4. Switch off and on again the device to enter in operating mode.

NOTE: The PRESET delete from the device memory all the associated wireless transmitters and the relative association with relay outputs. The PRESET also set all the relays in impulsive operating mode.

WIRELESS TRANSMITTERS PAIRING

(How to associate the wireless batteryless transmitters to the independent relays)

⚠ During the transmitters pairing phase, be sure that no batteryless transmitters with the same EnOcean transmission protocol are working near the area. Otherwise the receiver will not work properly during phase 4 of this pairing procedure.

1. Perform the power-on procedure.
2. Press and hold the CONFIG button for a time between 5s and 10s.
3. After releasing the button a simultaneous flash of CH1 – CH2 – CH3 – CH4 LEDs indicates the entrance inside the Pairing Menu.
4. Actuate the wireless transmitter that has to be associated to the receiver: when the signal is correctly received and identified CH1 and CH4 LEDs flash simultaneously one time.
5. By 2s press the CONFIG button as many time as the number of relay output you want to associate to the previously actuated transmitter.

Wireless

Instructions for use

6. After 2s without actions one flash of the selected LED indicates that the transmitter has been properly associated with the selected relay output.
7. Repeat this procedure from point 3 for all the transmitters you need to associate.
8. To each channel is possible to associate up to 28 transmitters. All the transmitters associated to the same relay will have the same assigned command function.
9. When all the needed transmitters are paired, turn the receiver off and than on again to enter in operating mode.

NOTE: per to delete a transmitter previously associated, at point 4 of this pairing procedure press the CONFIG button while all the relay will light off. After 2s without actions on simultaneous flash of CH1 – CH2 – CH3 – CH4 LEDs signal that the transmitter has been deleted from the receiver memory.

RELAY OPERATING MODE SETTING

1. Perform the power-on procedure.
2. Press and hold the CONFIG button for a time between 10s and 15s.
3. After releasing the button two simultaneous flash of CH1 – CH2 – CH3 – CH4 LEDs indicates the entrance inside the Operating Mode Setting Menu.
4. Press the CONFIG button as many time as needed to light up the desired LED (the number of the LED indicates the relay for witch you need to set the operating mode)
5. After 2s without actions the CH4 LED will start flash quickly: it is now possible to select the operating mode for the selected relay.
6. Press the CONFIG button for a number of times corresponding to the operating mode you need to select:
Press CONFIG button one time: Impulsive mode
Press CONFIG button two times: Maintained mode
Press CONFIG button three times: Reverse impulsive mode
Press CONFIG button four times: Reverse maintained mode
Press CONFIG button five times: Two-stage mode
7. After 2s without actions a double flash of CH1 – CH2 – CH3 – CH4 LEDs indicate the set of the selected operating mode.
8. Repeat this procedure from point 4 for all the relay you need to configure.
9. When all the needed relays are set, turn the receiver off and on again to enter in operating mode.

AVAILABLE RELAY OPERATING MODES

IMPULSIVE MODE: each transmitter actuation corresponds to a signal from the paired relay. The output signal has durability of 1s and is not maintained.

MAINTAINED MODE: each transmitter actuation corresponds to a change of status of the paired relay. The signal is maintained until a new incoming signal form one of the paired transmitters.

REVERSE IMPULSIVE MODE: each traction/release of the transmitter corresponds to a signal from the paired relay. The output signal has durability of 1s and is not maintained.

REVERSE MAINTAINED MODE: each transmitter traction/release corresponds to a change of status of the paired relay. The signal is maintained until a new incoming signal form one of the paired transmitters, generated by a traction or a release.

TWO_STAGE MODE: each transmitter actuation closes the associated relay output, until a subsequent release of the transmitter. The relay status replicates the real position of the actuator. In case one of the release signal will lost a new release signal will occur to restore the proper operating loop. Let 5s between consecutive actuation and release in order to guarantee maximum reliability of the transmission. In this operating mode each relay must have only in paired transmitter.

USAGE TIPS FOR THE DIFFERENT OPERATING MODES

The impulsive modes (1 and 3) were designed to give a start or power signal to a control unit, for example to start a machinery or open an automated door. The maintained modes (2 and 4) were designed to maintain the signal active for a certain time, commanding for example the illumination of an area or the start of a production line until an incoming off signal. The reverse operating modes (3 and 4) were designed to receive signals from batteryless rope switches. The two-stage operating mode (5) was designed to reply the real position of the actuator on the transmitter, with signaling function for a certain event, for example the opening of a door or a window. Pay attention to the limit of use of the device: these switches must not substitute safety signals expected on machinery or on the plant for emergency situations or to guarantee the functional safety of the system.

MANAGE OF THE INCOMING TRANSMISSIONS

To each relay output it is possible to pair up to 28 transmitters, each paired transmitter will have the same functionality of the others with whom shares the destination output channel.

If the receiver manages only a single output the max. operating frequency of the transmitter can be up to 3600 operations per hour (10p/s). Higher operating frequency can wear and break the transmitter, as well as a loss of transmission reliability. If the receiver simultaneously manages more than one output the operating frequency have to be decreased down to 1800 operations per hour on the single output (0,5op/s). This operating slowdown allows to maintain the same transmission reliability also when the receiver have to manage simultaneous transmissions that have to be sort to the four available output relays. In case of two simultaneous transmissions ($\Delta < 1s$) directed to the same output relay they would overlap using impulsive operating modes, while they would collide using the maintained operating modes. When using the two-stage operative mode, it is necessary to foresee a –minimum time of 5s between the actuation and release signal of the transmitter, this will allow to maintain high transmission reliability and minimize loss of signal and consequently the necessity to restore the proper transmission loop. In general, with the target to obtain a perfect wireless experience, it is recommended to think well about the operating mode to be used and design well the number of receiver and transmitters to be used on the working area. COMEPI technical support is available to give assistance and find the best solution for any application where it is necessary: tecnico@comepi.it

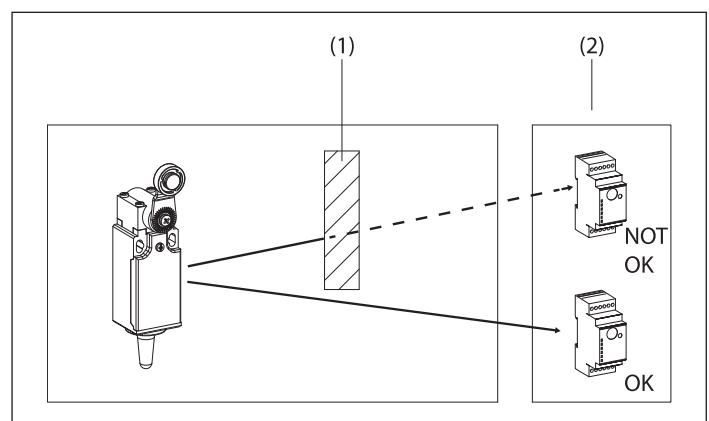

MOUNTING AND WIRING

Mount the fixed transmitter on a plain surface. Be sure that the portable device will be always available inside the working area. The wireless batteryless transmitter have to be paired and configured following the instruction contained inside this manual. The operating range depends a lot from the environmental conditions of the working area. The radio signal can be obscured and attenuated by conductive materials. This is valid also for thin foils like the aluminum coatings on insulating materials. It is necessary to design as well as possible the working area in order to maximize the performances of the devices using the installation tips reported inside the technical documentation.

Wireless

Instructions for use

OPERATING RANGE CONSIDERATIONS

Since they are radio signals there are electromagnetic waves and the signal intensity can be lowered along the path from transmitter to receiver. This means that the signal goes lowered both in electrical and magnetic fields intensity, inversely proportional to the square of the distance ($E, H \sim 1/r^2$). In addition to the distance, other sources of disturbances can be metallic parts, for example wall armors, metal foils for thermal insulation, metallized safety glasses. All of them can reflect the wireless signal, lowering its range. Behind these a shaded area may form: however much the waves can penetrate these obstacles, they will have an impact on operating range. Following an example of signal lowering power of various materials:

Material	Attenuation of signal through the material
Metal parts	Between 50 and 100%
Concrete walls	Between 70 and 80%
Brick walls	Between 50 and 70%
Drywall	Between 30 and 45%
FinestraGlass window or wood panel	Between 10 and 20%

NOTE: The values inside this table are purely indicative. Real values can change according to thickness and specific composition of the material to be penetrated by the signal.

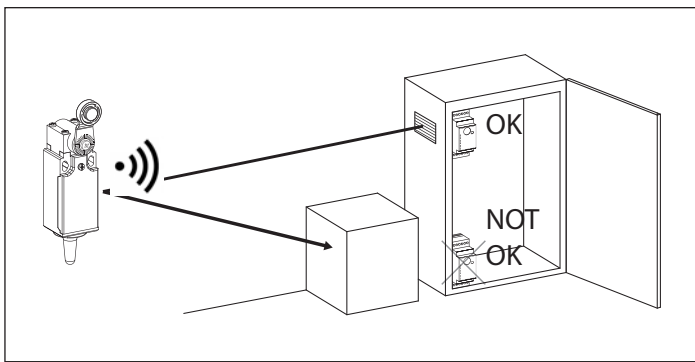

The radio signal generated by transmitter develops with elliptical shape, where receiver and transmitter are located at the focal points. Because of this the working area shape near the device can condition the operating distance. E.g. the installation in narrow corridors with shielding walls reduces the operating range.

TYPICAL OPERATING DISTANCES

Open fields operation without obstacles: about 80 meters
 Industrial environment operations: About 30 meters
 Industrial environmental operations, with concrete obstacles on the way (drywalls, metal shelves): about 20 meters if the receiver is properly installed with antenna
 Industrial environmental operations, with concrete obstacles on the way (drywalls, metal shelves): less than 10 meters if the receiver is mounted behind a shielding wall, if the receiver is mounted on a corner of the room, if a suitable antenna is not properly installed.

ANTENNAS ORIENTATION



SIGNAL LED USE

The SIGNAL LED can be used as diagnostic tool in order to verify the proper installation conditions for the involved devices. The LED lights up green when the signal has an intensity over the 50% of its rated value. When the SIGNAL LED lights up yellow the signal has an intensity under the 50% of its rated value. When the SIGNAL LED lights up yellow the signal is anyway received and processed by the receiver, but is suggested to better set the working area in order to maximize the performance of the involved devices.

MAINTENANCE

Do not disassemble or try to repair the device. In case of damages or faults replace the all device. The sequence of functional tests to whom the device will be submitted is responsibility of the installer. Installation must be performed according to the standard in forces and performed exclusively by qualified operators. Be sure to install the device in places difficult to reach for unauthorized people.

DEVICE INSTALLATION

The receiver must be installed in a proper environment according to its declared IP protection degree. The receiver has to be fixed in a solid and plain way on the DIN rail. The device has 2M width on DIN rail. It is suggested to install the RRH8/RRH9 receiver with a distance at least of 50cm from any high frequency disturbance source (pc, audio or video equipment, etc.) or other transmission sources (GSM, WI-FI, etc.). Transmitter RFH8/RFH9 could be installed at any distance between these sources. Use only installation wires with length down to 3m to connect the receiver.

ANTENNA

The receiver must be equipped, during its normal operations, with a radio frequency antenna, approved according to the referent Directives and suitable to receiving 868MHz (RRH8) or 902MHz (RRH9) signals. The antenna must be screwed on the SMA connector located on the receiver. The connector on the receiver is a female SMA type. The connector on the antenna is a male SMA type. The antenna must be fixed without exceed in screwing torque and not forced in its place. In case of breakages due to a higher torque using to fix the antenna, the warranty condition expire and COMEPI will not substitute the device in warranty. The use of the antenna is necessary to guarantee the rated performances of the device. For a proper use, COMEPI makes it available the following accessories that can be bought separately:

- ANT86801 → Orientable antenna for RRH8
- ANT86802 → Antenna with cable for RRH8
- ANT90201 → Orientable antenna for RRH9
- ANT90202 → Antenna with cable for RRH9



More details available on website www.comepi.eu and technical catalogue.

ADDITIONAL PRECAUTIONS FOR USE

Verify periodically the proper operations of the device as reported in maintenance section – The installation must be performed only by qualified operators – The use of this device must be conform to the limit of use specified and allowed by the standard in forces - The installation of the device must be performed only by people who knows well the reference standard in forces – Installation of the device must be performed according the standard in forces – This product is not designed to be integrated in a safety system, it have to be used in applications without scope of protection for people or equipment – In case of any doubt or particular applications contact the COMEPI's technical assistance – Make this instruction sheet available on the technical documentation of the machinery where this device is mounted – Make this instruction sheet always available for the operators who are going to use the machine where this device is mounted – Before eventual painting or similar works protect the label of the device – Do not remove the label of the device, the absence of label makes the CE mark of the device expire – Do not install in presence of strong vibrations and shocks, these conditions can damage the device and don't let it work properly – Do not modify the device in its construction – Do not dismantle and re-assemble the device – Substitute the device after passing the mechanical durability limit (1M

Notes

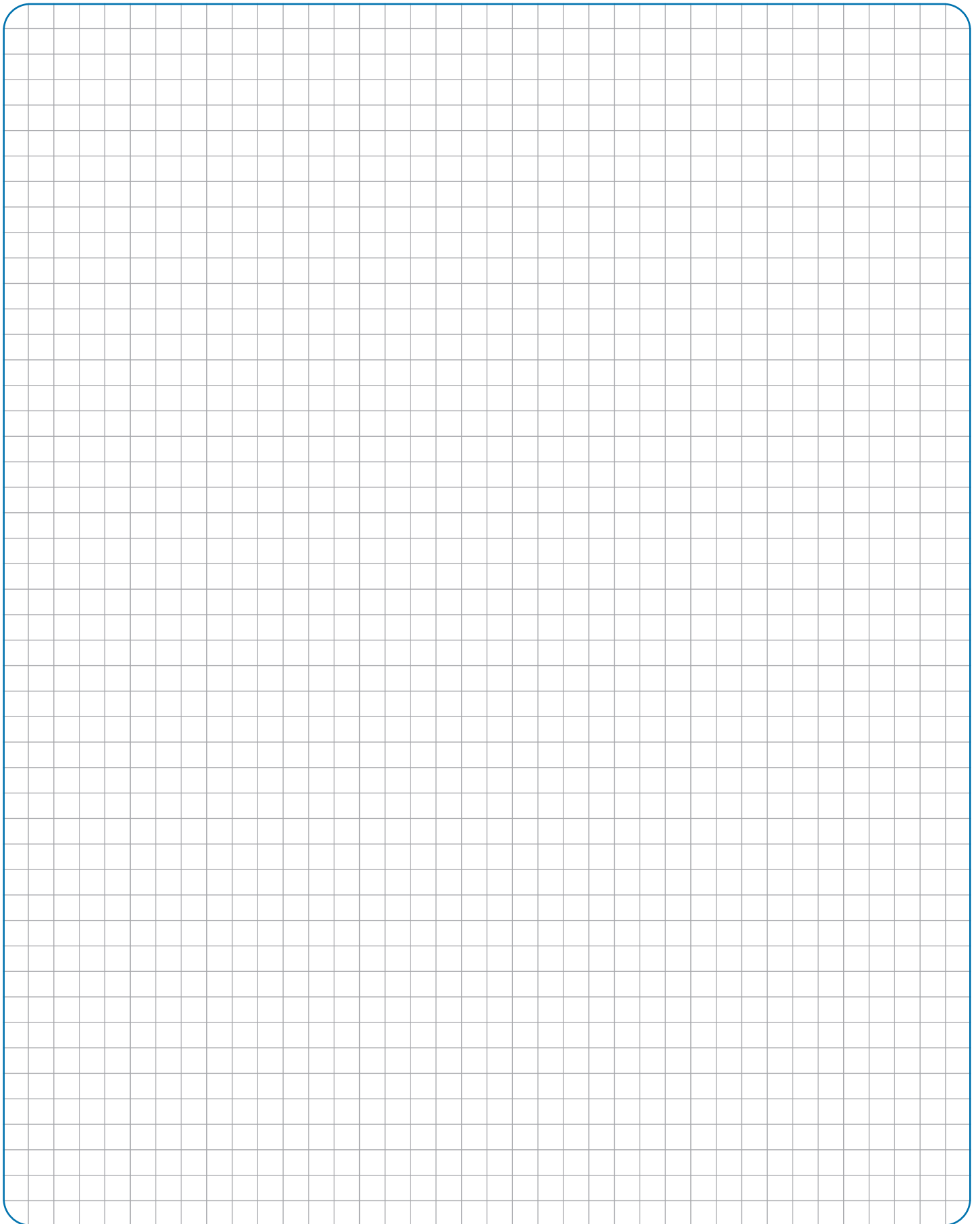

Notes

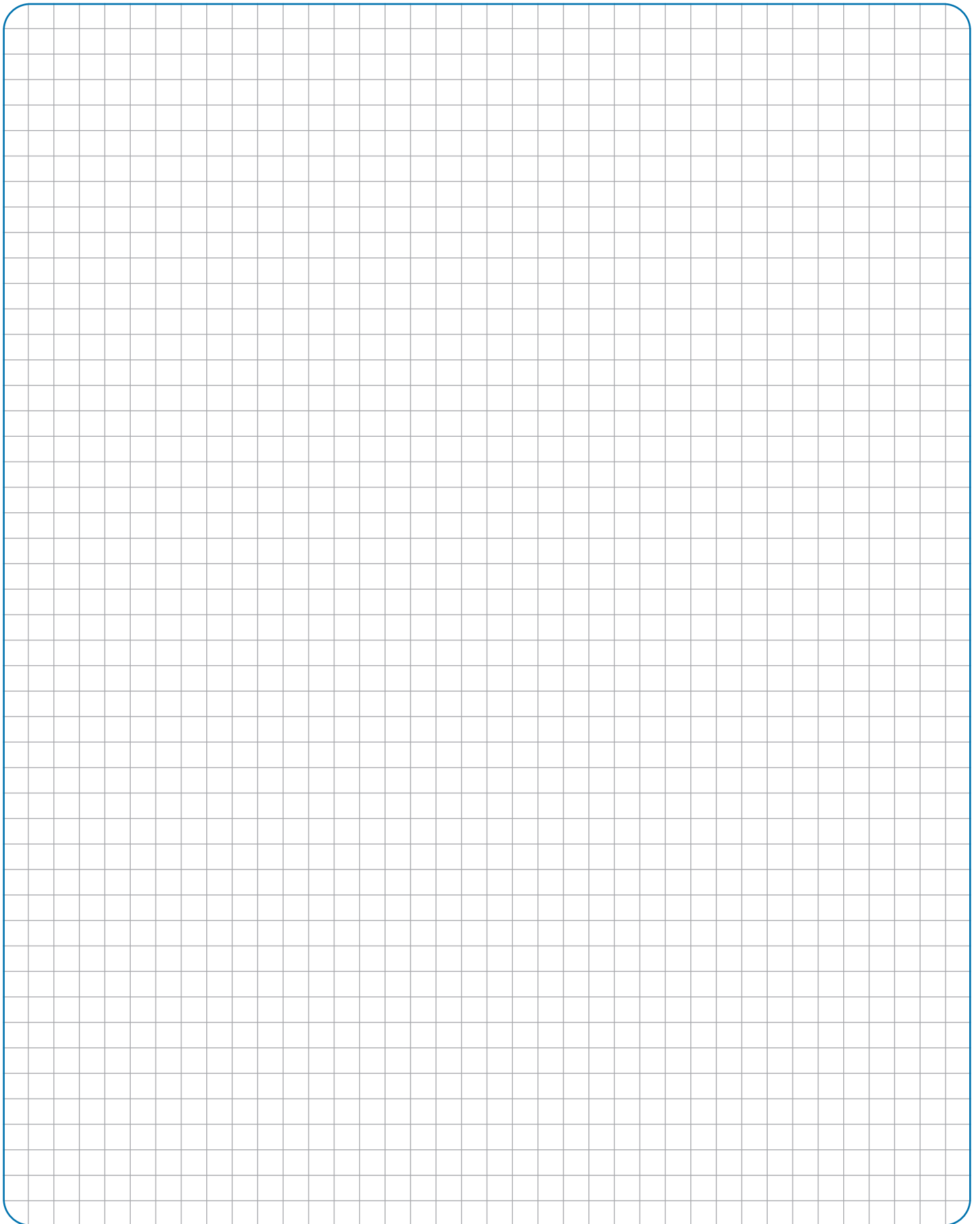

Notes

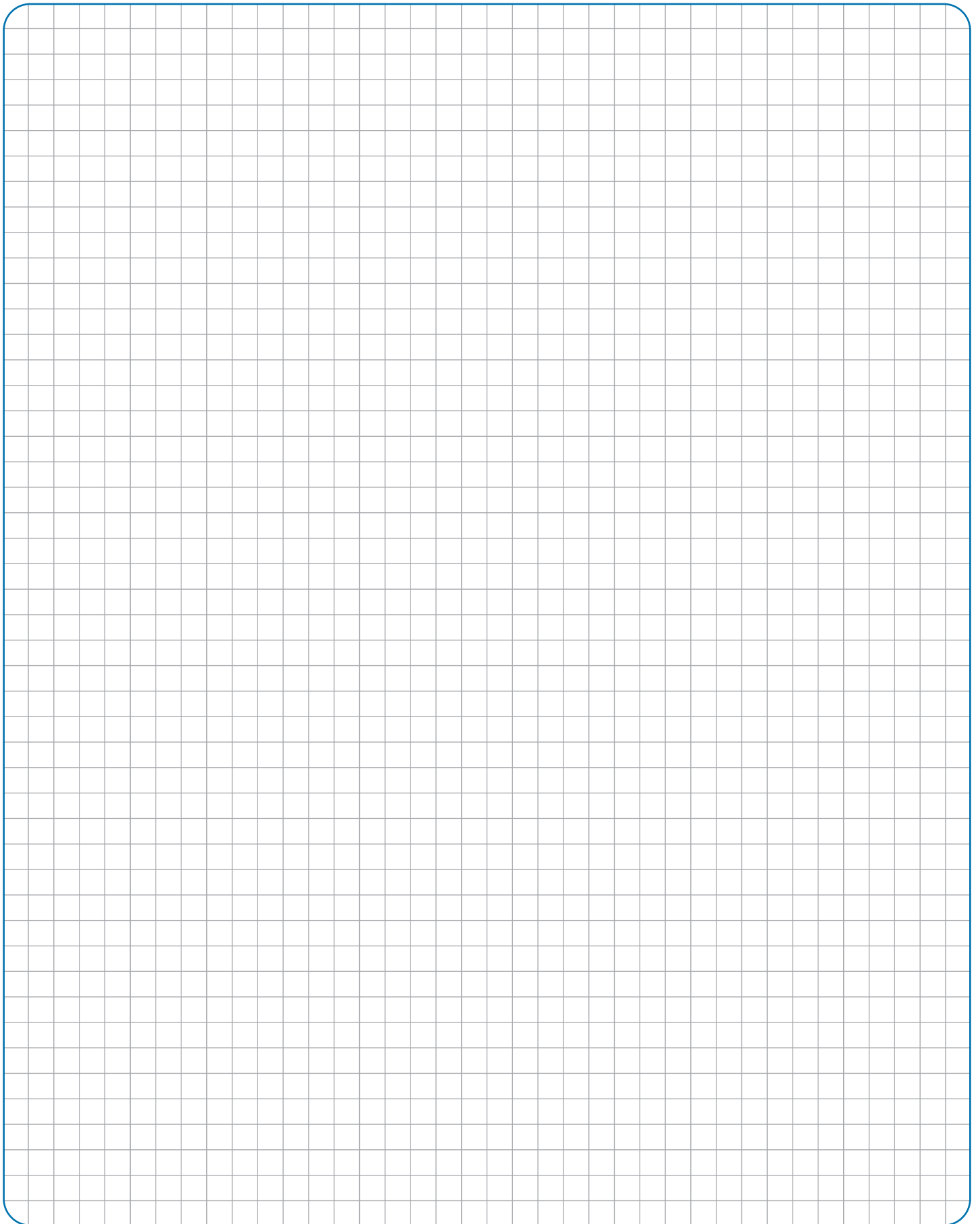

Notes

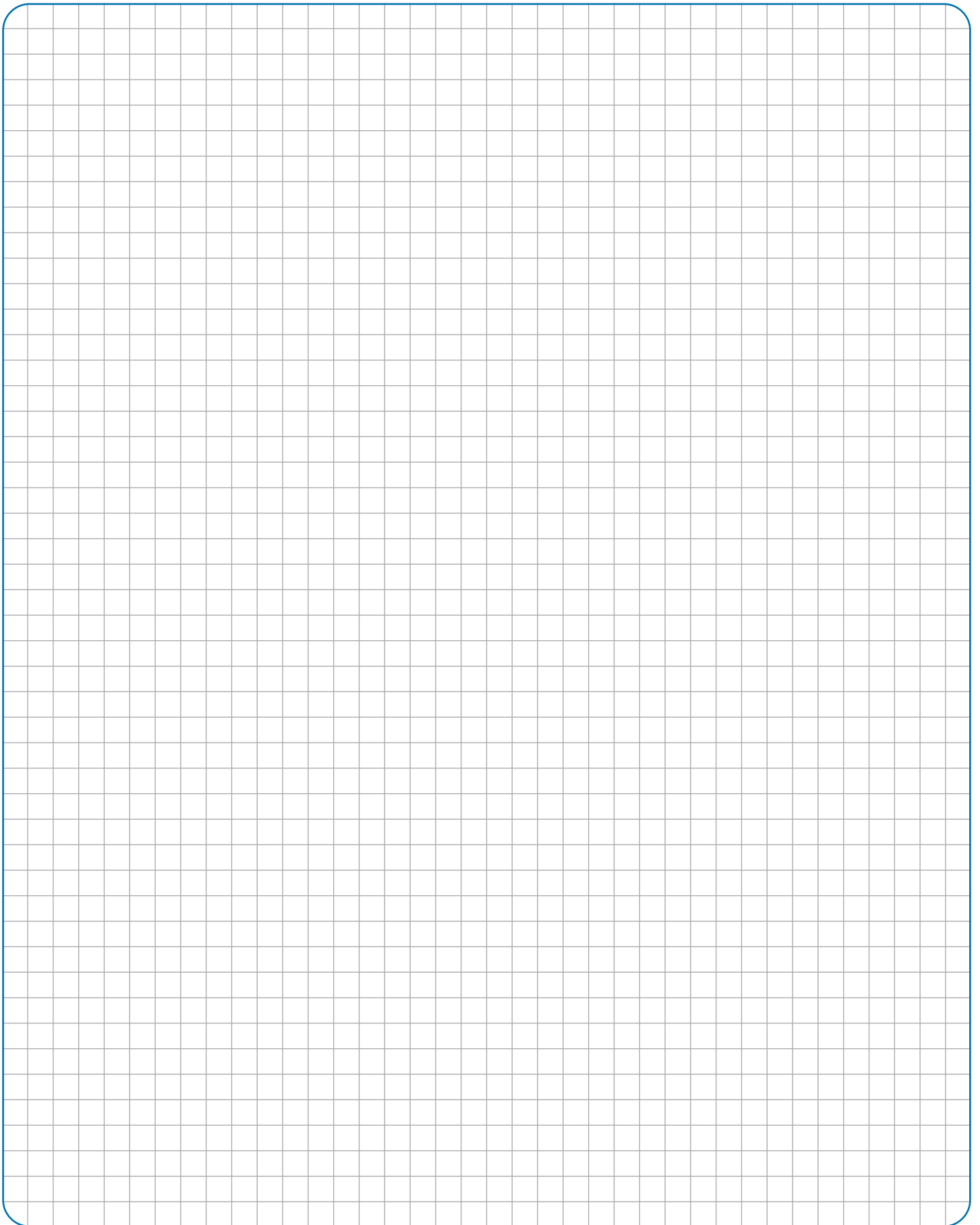

COMEPI AROUND THE WORLD

Comepi products are available all over the world, the company supplies 76 countries in 5 continents. Our focus on flexibility translates into the ability to create solutions where the market requires new application needs. Comepi has a network of agents and importers, supported by local distributors. This organization ensures global presence and support.



23899 Robbiate
(Lecco) Italy
Via Novarino 9/L
tel. +039 990 6408
+039 990 6203
comepi@comepi.it
comepi.eu

 **COMEPI**



CAT141-SC1022-PX