

LIMIT SWITCHES

2022

Limit Switches

Index

	Limit Switches - AP series	page 2
	Limit Switches - DP series	page 12
	Limit Switches - AM series	page 22
	Limit Switches - DM series	page 32
	Limit Switches - BP series	page 42
	Limit Switches - BM series	page 50
	Limit Switches - CM series	page 62
	Limit Switches - EP series	page 74
	Limit Switches - EM series	page 88
	Limit Switches - GP series	page 102
	Control Cabinet Devices	page 108
	Special Applications	page 112

Limit Switches AP series

Summary

APPROVALS: UL 508 / CSA C22-2 N. 14 / IEC 60947-5-1



CB-SCHEME certification according to IEC 60947-5-1

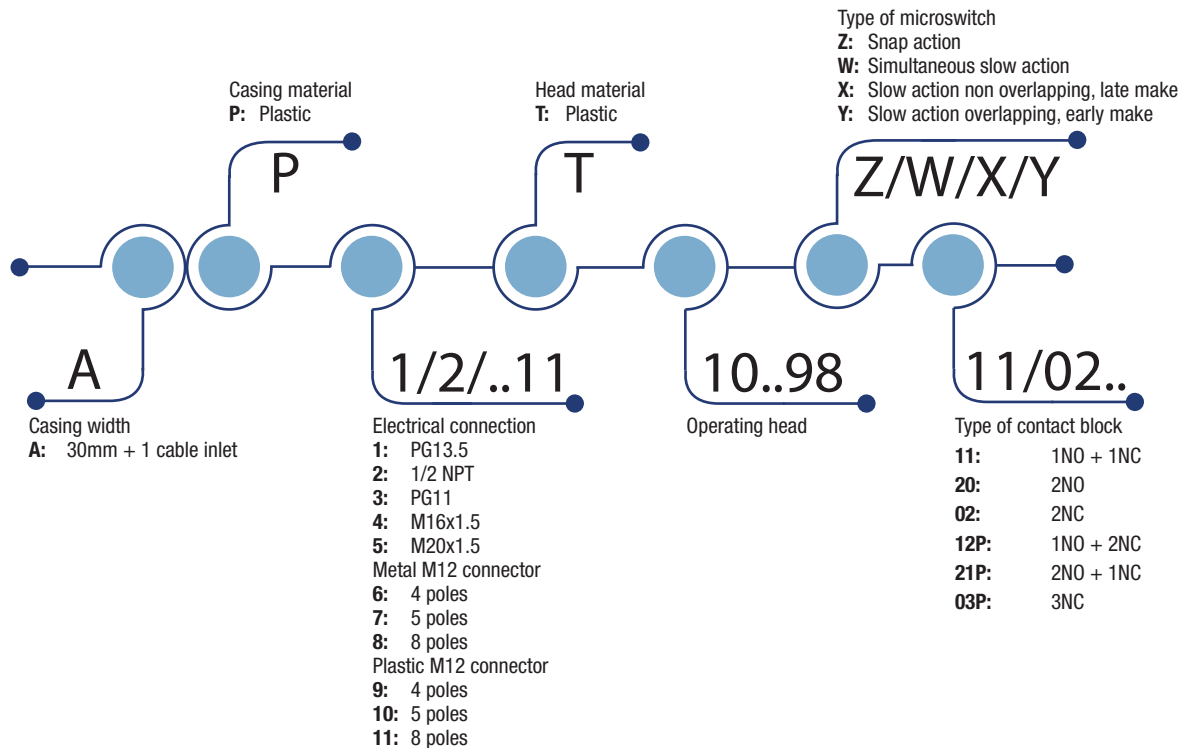

HOW IS IT MADE?

01 A variety of actuators

- Plain plunger
- Roller plunger
- Roller lever, adjustable or not, etc.

02 Wide range of heads

- Assembled using 4 x Ø3 screws

03 Casing:

- 30 mm. width with standardized dimensions acc. to EN 50047

04 Mounting screws

- 2 x M4 screws on top part

05 Cover

- 1 screw Ø3 pozidriv 1

06 Contact Block

- Positive opening operation
- Snap action or slow action
- Electrically separated contacts

07 Connecting terminals

- Block of 2 contacts: M3.5 (+, -) pozidriv 2 screw
- Block of 3 contacts: M3 (+, -) screw
- Screw head with captive cable clamp
- Markings conform with IEC 60947-1, IEC 60947-5-1 standards

08 Electrical connection

- 1 x threaded cable entry suitable for cable gland, M12 connector or DEUTSCH connector

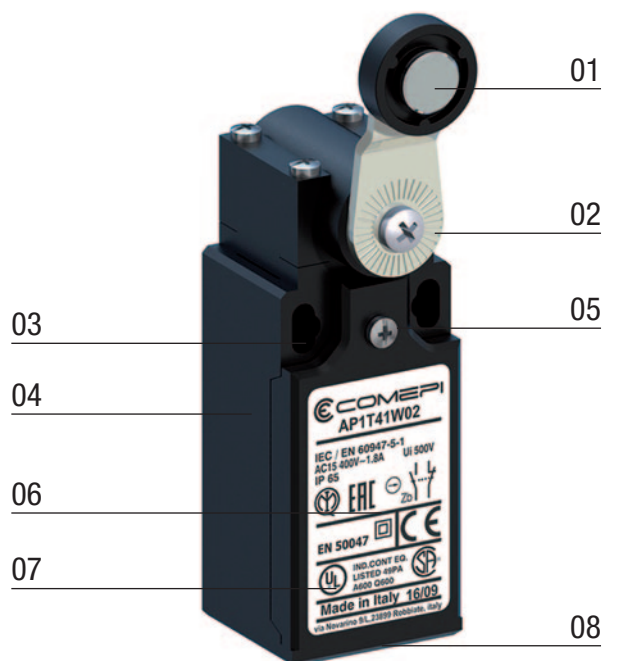

Limit Switches **AP series**

Description

APPLICATIONS

Easy to use, electromechanical limit switches offer specific qualities:

- Visible operation.
- Able to switch strong currents (10 A conventional thermal current).
- Electrically separated contacts.
- Precise operating points (consistency).
- Immune to electromagnetic disturbances.

They are purpose-built detection devices thanks to these characteristics:

- Presence/absence.
- Positioning and travel limit.
- Objects passing/counting.

DESCRIPTION

Limit switches, which are made of reinforced UL-VO thermoplastic fiber-glass, offer double insulation  and a degree of protection of IP65.

They comply with the requirements of European Directives (Low Voltage and RoHS) and are conform to European and International Standards.

The CE declaration of these products are available in the download section of website www.comepi.it or by writing to the following email address: tecnico@comepi.it
DDC02 - Limit Switches.

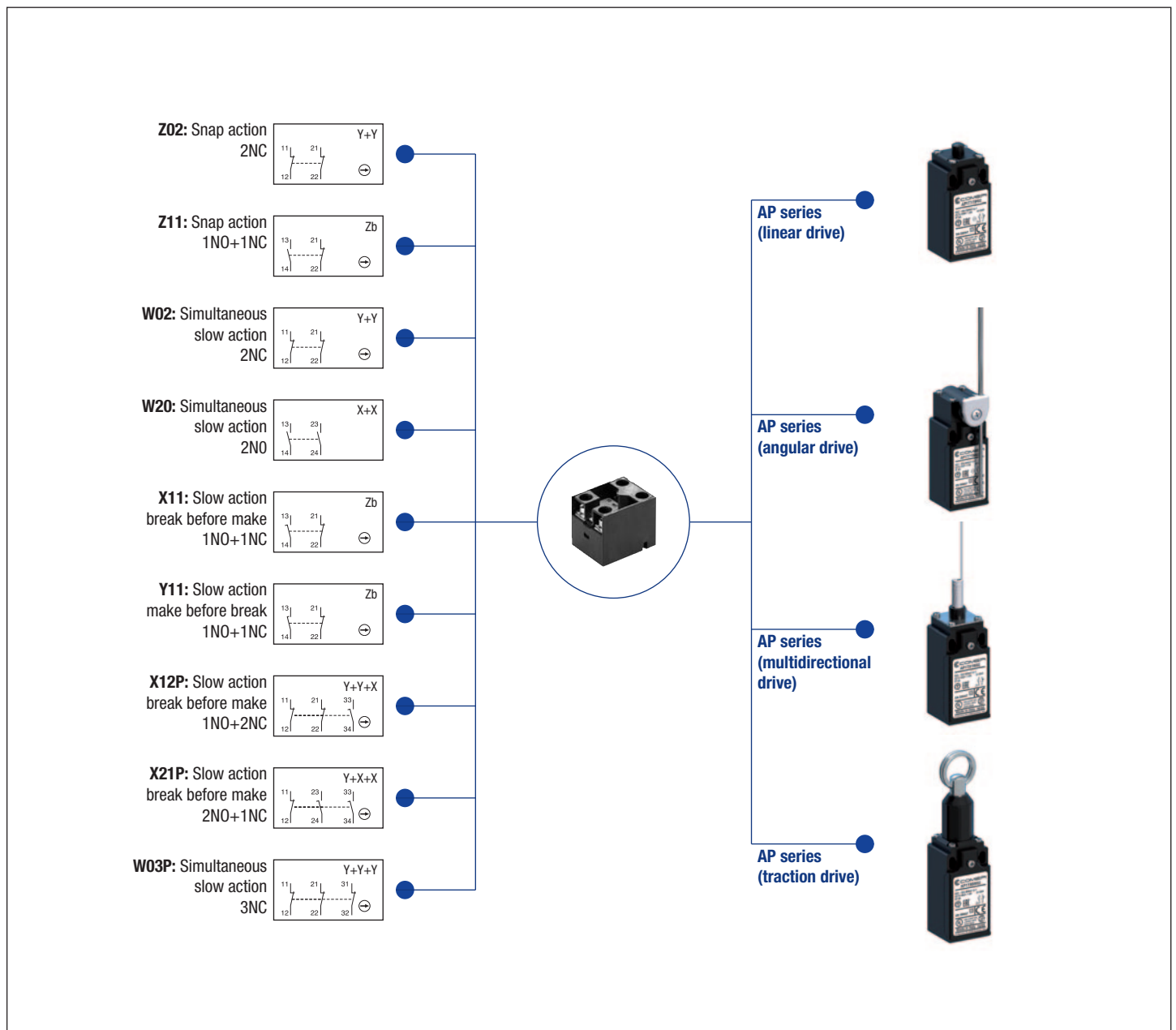

Limit Switches **AP series**

Technical Data

	AP Series	
Standards	IEC 60947-5-1 EN 60947-5-1	
Certifications - Approvals	UL - CSA - IMQ - EAC - CCC - UKCA	
Air temperature near the device		
– during operation	°C	– 25 ... + 70
– for storage	°C	– 30 ... + 80
Mounting positions	All positions are authorised	
Protection against electrical shocks (acc. to IEC 61140)	Class II	
Degree of protection (according to IEC 60529 and EN 60529)	IP65 (for all models) - IP67 (only for operating heads from 10 to 39)	

Electrical Data

Rated insulation voltage U_i - according to IEC 60947-1 and EN 60947-1 - according to UL 508 and CSA C22-2 n° 14	500 V (degree of pollution 3) (400 V for contacts type Z02, X12P, X21P, W03P) A 600, Q 600 (A 300, Q 300 for contacts type X12P, X21P, W03P)	
Rated impulse withstand voltage U_{imp} (according to IEC 60947-1 and EN 60947-1)	kV	6
Conventional free air thermal current I_{th} (according to IEC 60947-5-1) $\theta < 40$ °C	A	10
Short-circuit protection $U_e < 500$ V a.c. - gG (gl) type fuses	A	10
Rated operational current I_e / AC-15 (according to IEC 60947-5-1)	24 V - 50/60 Hz A 120 V - 50/60 Hz A 400 V - 50/60 Hz A	10 6 4
I_e / DC-13 (according to IEC 60947-5-1)	24 V - d.c. A 125 V - d.c. A 250 V - d.c. A	6 0.55 0.4
Switching frequency	Cycles/h	3600
Load factor		0.5
Resistance between contacts	m Ω	25
Connecting terminals	M3.5 (+, -) pozidriv 2 screw with cable clamp (M3 for 3 poles contacts type)	
Terminal for protective conductor	-	
Recommended tightening torque	Plastic	
Cover	0,5Nm, max 0,8	
Head	0,5Nm, max 0,8	
Microswitch	0,8Nm, max 0,9	
Connecting capacity	1 or 2 x mm ²	0.34 ... 2.5 (0.34... 1.5 for 3 poles contacts type)
Terminal marking	According to IEC 60947-5-1	
Mechanical durability	15 millions of operations 10 millions of operations >5 millions of operations	T10...12; T21; T2101; T30...34; T38 T13; T41...48; T51...55; T61...75 T14; T35; T36; T39; T91...93; T98
Electrical durability (according to IEC 60947-5-1)	Utilization categories AC-15 and DC-13 (Load factor of 0.5 according to curves below)	

AC-15 - Snap action

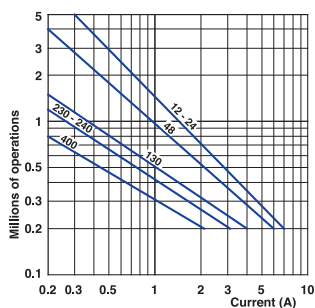

AC-15 - Slow action

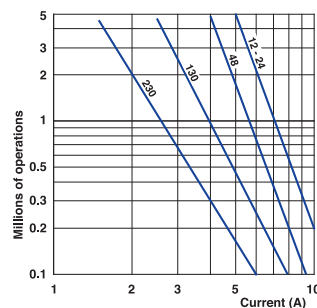

DC-13	Snap action	Slow action
		Power breaking for a durability of 5 million operating cycles
Voltage 24 V	9.5 W	12 W
Voltage 48 V	6.8 W	9 W
Voltage 110 V	3.6 W	6 W

Limit Switches AP series

Technical Data

Technical data approved by IMQ

Standards	Devices conform with international IEC 60947-5-1 and European EN 60947-5-1 standards	
Degree of protection	IP 65	
Rated insulation voltage U_i	500 V (degree of pollution 3) (400V for type Z02, X12P, X21P, W03P)	
Rated impulse withstand voltage U_{imp}	6 kV	
Conventional free air thermal current I_{th}	10 A	
Short-circuit protection - gG (gl) type fuses	10 A	
Rated operational current		
I_e / AC-15	24 V - 50/60 Hz	10 A
	400 V - 50/60 Hz	4 A
I_e / DC-13	24 V - d.c.	6 A
	125 V - d.c.	0.55 A
	250 V - d.c.	0.4 A

IMPLEMENTATION

Operating head orientation

The head can be rotated each 90°. Recommended tightening torque 0,5 Nm (max 0,8 Nm).

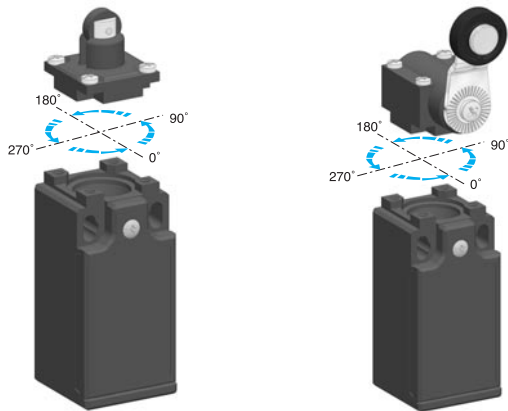

Technical data approved by UL

Standards	Devices conform with UL 508
Contact blocks type Z11, X11, Y11, W02 and Z02	
Utilization categories	A600, Q600
Contact blocks type X12P, X21P and W03P	
Utilization categories	A300, Q300

Use 60/75°C copper (Cu) conductor only. Wire rages 14-18 AWG stranded or solid. The terminal tightening torque of 7 lbs-in / 0.78 Nm. Suitable for conduit connection only with use of adapter sleeve optionally provided or recommended by the manufacturer.

For the complete list of approved products, contact our technical department

Lever adjustment

The lever of the angular actuators can be adjusted every 10° and round turned in order to obtain the maximum flexibility on the working plan. Recommended tightening torque 0,5 Nm (max 0,8 Nm).

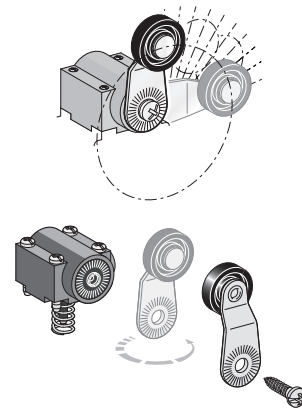

Special Versions

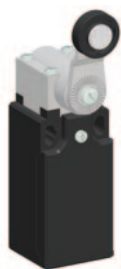

Metal actuators

The operating heads used in plastic limit switches AP and DP series have the same dimensions of the ones used in the corresponding metal AM and DM series. It is therefore possible to supply "mixed" versions, that is:

- plastic operating head on metal casing
- metal operating head on plastic casing

Manual reset operating head

Limit switches equipped with special operating head with manual reset button.

For more information:



For further informations, please contact our technical department.

Low Temperature

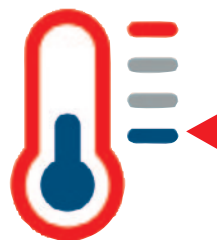

The limit switches for low temperature applications are useful for refrigerated cells or equipments where the air operational temperature is very low. These devices, made in special materials, are able to extend the operational temperature range down to -40°C, maintaining mechanical performances intact.

To order add the digits "40" following the operating head indication in part number.

For example: AP1T10Z11 → AP1T1040Z11

Limit Switches AP_T series

Double insulation - Plastic casing IP65 - 30 mm. width

Electrical connection:

- AP1: one cable inlet for PG 13,5 Cable Gland
- AP2: one cable inlet by 1/2" NPT Plastic Adapter
- AP3: one cable inlet for PG11 Cable Gland
- AP4: one cable inlet for M16 x 1,5 Cable Gland
- AP5: one cable inlet for M20 x 1,5 Cable Gland
- AP6: 4 poles M12 metal connector
- AP7: 5 poles M12 metal connector
- AP8: 8 poles M12 metal connector
- AP9: 4 poles M12 plastic connector
- AP10: 5 poles M12 plastic connector
- AP11: 8 poles M12 plastic connector

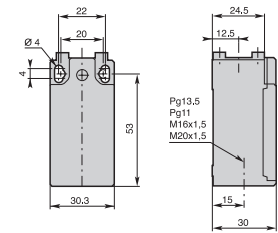

Contact Blocks

Z11 (1NO + 1NC)	AP•T10Z11	AP•T11Z11	AP•T12Z11	AP•T13Z11	AP•T14Z11
X11 (1NO + 1NC)	AP•T10X11	AP•T11X11	AP•T12X11	AP•T13X11	AP•T14X11
Y11 (1NO + 1NC)	AP•T10Y11	AP•T11Y11	AP•T12Y11	AP•T13Y11	AP•T14Y11
W02 (2NC)	AP•T10W02	AP•T11W02	AP•T12W02	AP•T13W02	AP•T14W02
W20 (2NO)	AP•T10W20	AP•T11W20	AP•T12W20	AP•T13W20	AP•T14W20
Z02 (2NC)	AP•T10Z02	AP•T11Z02	AP•T12Z02	AP•T13Z02	AP•T14Z02
X12P (1NO + 2NC)	AP•T10X12P	AP•T11X12P	AP•T12X12P	AP•T13X12P	AP•T14X12P
X21P (2NO + 1NC)	AP•T10X21P	AP•T11X21P	AP•T12X21P	AP•T13X21P	AP•T14X21P
W03P (3NC)	AP•T10W03P	AP•T11W03P	AP•T12W03P	AP•T13W03P	AP•T14W03P

T1 - Plain plunger

T10: nylon plunger T11: metal plunger

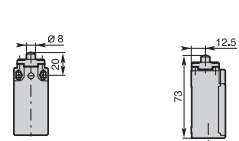

Conformity EN50047
Min. actuating force
Weight

15N (30N ⇄)
70 g

T1 - Roller plunger

T12: metal roller T13: nylon roller

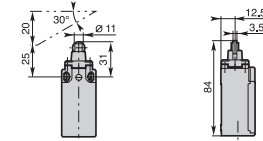

Conformity EN50047
Min. actuating force
Weight

12N (30N ⇄)
75 g

T14 - Metal plunger with dust protection cup

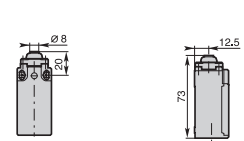

Conformity EN50047
Min. actuating force
Weight

15N (30N ⇄)
70 g

T21 - Plain plunger with M18x1 fixing nuts

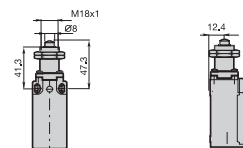

Min. actuating force
Weight

15N (30N ⇄)
80 g

T2101 - Plain plunger with M12x1 fixing nuts

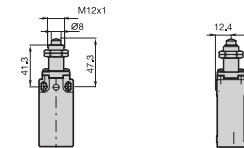

Min. actuating force
Weight

15N (30N ⇄)
80 g

T3 - Plastic roller lever

T30: on plastic plunger T31: on metal plunger

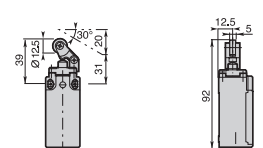

Conformity EN50047
Min. actuating force
Weight

7N (24N ⇄)
75 g

Contact Blocks

Z11 (1NO + 1NC)	AP•T21Z11	AP•T2101Z11	AP•T30Z11	AP•T31Z11
X11 (1NO + 1NC)	AP•T21X11	AP•T2101X11	AP•T30X11	AP•T31X11
Y11 (1NO + 1NC)	AP•T21Y11	AP•T2101Y11	AP•T30Y11	AP•T31Y11
W02 (2NC)	AP•T21W02	AP•T2101W02	AP•T30W02	AP•T31W02
W20 (2NO)	AP•T21W20	AP•T2101W20	AP•T30W20	AP•T31W20
Z02 (2NC)	AP•T21Z02	AP•T2101Z02	AP•T30Z02	AP•T31Z02
X12P (1NO + 2NC)	AP•T21X12P	AP•T2101X12P	AP•T30X12P	AP•T31X12P
X21P (2NO + 1NC)	AP•T21X21P	AP•T2101X21P	AP•T30X21P	AP•T31X21P
W03P (3NC)	AP•T21W03P	AP•T2101W03P	AP•T30W03P	AP•T31W03

Operation diagrams: page 123 - All dimensions are in mm

Limit Switches AP_T series

Double insulation - Plastic casing IP65 - 30 mm. width

Electrical connection:

- AP1: one cable inlet for PG 13,5 Cable Gland
- AP2: one cable inlet by 1/2" NPT Plastic Adapter
- AP3: one cable inlet for PG11 Cable Gland
- AP4: one cable inlet for M16 x 1,5 Cable Gland
- AP5: one cable inlet for M20 x 1,5 Cable Gland
- AP6: 4 poles M12 metal connector
- AP7: 5 poles M12 metal connector
- AP8: 8 poles M12 metal connector
- AP9: 4 poles M12 plastic connector
- AP10: 5 poles M12 plastic connector
- AP11: 8 poles M12 plastic connector

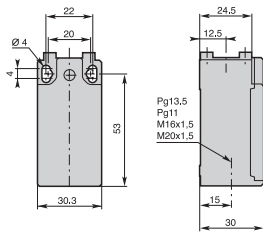

Contact Blocks

Z11 (1NO + 1NC)	AP•T32Z11	AP•T34Z11	AP•T35Z11	AP•T36Z11
X11 (1NO + 1NC)	AP•T32X11	AP•T34X11	AP•T35X11	AP•T36X11
Y11 (1NO + 1NC)	AP•T32Y11	AP•T34Y11	AP•T35Y11	AP•T36Y11
W02 (2NC)	AP•T32W02	AP•T34W02	AP•T35W02	AP•T36W02
W20 (2NO)	AP•T32W20	AP•T34W20	AP•T35W20	AP•T36W20
Z02 (2NC)	AP•T32Z02	AP•T34Z02	AP•T35Z02	AP•T36Z02
X12P (1NO + 2NC)	AP•T32X12P	AP•T34X12P	AP•T35X12P	AP•T36X12P
X21P (2NO + 1NC)	AP•T32X21P	AP•T34X21P	AP•T35X21P	AP•T36X21P
W03P (3NC)	AP•T32W03P	AP•T34W03P	AP•T35W03P	AP•T36W03P

T3 - Plastic roller lever

T32: on metal plunger T34: on plastic plunger

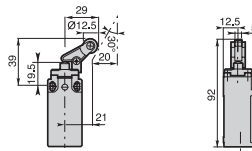

Min. actuating force
Weight

7N (24N ⇄)
80 g

T35 - Plastic roller lever on metal plunger with dust protection cup

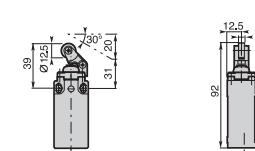

Conformity EN50047
Min. actuating force
Weight

7N (24N ⇄)
75 g

T36 - Plastic roller lever on metal plunger with dust protection cup

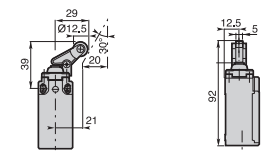

Min. actuating force
Weight

7N (24N ⇄)
80 g

T38 - Adjustable plastic roller lever on metal plunger

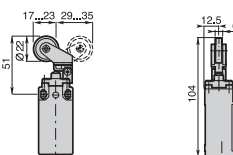

Conformity EN50047
Min. actuating force
Weight

7N (24N ⇄)
80 g

T39 - Adjustable plastic roller lever on metal plunger with dust protection cup

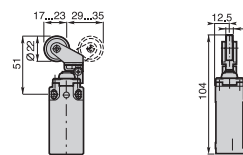

Conformity EN50047
Min. actuating force
Weight

7N (24N ⇄)
80 g

T41 - Ø 18 nylon roller lever

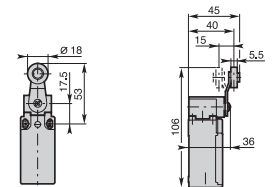

Conformity EN50047
Min. actuating torque
Weight

0,10Nm (0,32Nm ⇄)
95 g

Contact Blocks

Z11 (1NO + 1NC)	AP•T38Z11	AP•T39Z11	AP•T41Z11
X11 (1NO + 1NC)	AP•T38X11	AP•T39X11	AP•T41X11
Y11 (1NO + 1NC)	AP•T38Y11	AP•T39Y11	AP•T41Y11
W02 (2NC)	AP•T38W02	AP•T39W02	AP•T41W02
W20 (2NO)	AP•T38W20	AP•T39W20	AP•T41W20
Z02 (2NC)	AP•T38Z02	AP•T39Z02	AP•T41Z02
X12P (1NO + 2NC)	AP•T38X12P	AP•T39X12P	AP•T41X12P
X21P (2NO + 1NC)	AP•T38X21P	AP•T39X21P	AP•T41X21P
W03P (3NC)	AP•T38W03P	AP•T39W03P	AP•T41W03P

Operation diagrams: page 123 - All dimensions are in mm

Limit Switches AP_T series

Double insulation - Plastic casing IP65 - 30 mm. width

Electrical connection:

- AP1: one cable inlet for PG 13,5 Cable Gland
- AP2: one cable inlet by 1/2" NPT Plastic Adapter
- AP3: one cable inlet for PG11 Cable Gland
- AP4: one cable inlet for M16 x 1,5 Cable Gland
- AP5: one cable inlet for M20 x 1,5 Cable Gland
- AP6: 4 poles M12 metal connector
- AP7: 5 poles M12 metal connector
- AP8: 8 poles M12 metal connector
- AP9: 4 poles M12 plastic connector
- AP10: 5 poles M12 plastic connector
- AP11: 8 poles M12 plastic connector

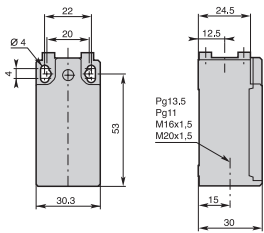

Contact Blocks

- Z11 (1NO + 1NC)
- X11 (1NO + 1NC)
- Y11 (1NO + 1NC)
- W02 (2NC)
- W20 (2NO)
- Z02 (2NC)
- X12P (1NO + 2NC)
- X21P (2NO + 1NC)
- W03P (3NC)

T42 - Ø 50 rubber roller lever

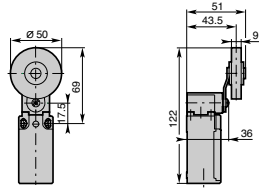

Min. actuating torque 0,10Nm (0,32Nm ⊖)
Weight 115 g

T43 - Ø 18 metal roller lever

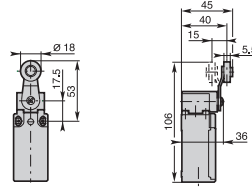

Conformity EN50047

Min. actuating torque 0,10Nm (0,32Nm ⊖)
Weight 100 g

T45 - Ø 18 nylon roller lever

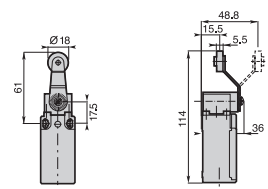

Min. actuating torque 0,10Nm (0,32Nm ⊖)
Weight 95 g

T46 - Ø 18 metal roller lever

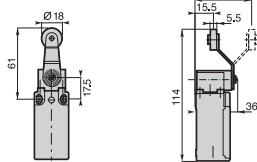

Min. actuating torque 0,10Nm (0,32Nm ⊖)
Weight 100 g

T48 - Ceramic rod lever

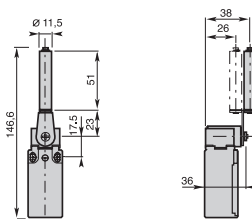

Min. actuating torque 0,10Nm (0,32Nm ⊖)
Weight 100 g

T51 - Adjustable lever with Ø 18 nylon roller

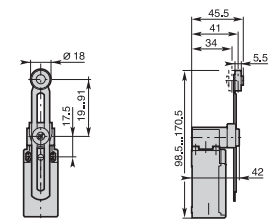

Min. actuating torque 0,10Nm (0,32Nm ⊖)
Weight 100 g

Contact Blocks

- Z11 (1NO + 1NC)
- X11 (1NO + 1NC)
- Y11 (1NO + 1NC)
- W02 (2NC)
- W20 (2NO)
- Z02 (2NC)
- X12P (1NO + 2NC)
- X21P (2NO + 1NC)
- W03P (3NC)

- AP•T46Z11
- AP•T46X11
- AP•T46Y11
- AP•T46W02
- AP•T46W20
- AP•T46Z02
- AP•T46X12P
- AP•T46X21P
- AP•T46W03P

- AP•T48Z11
- AP•T48X11
- AP•T48Y11
- AP•T48W02
- AP•T48W20
- AP•T48Z02
- AP•T48X12P
- AP•T48X21P
- AP•T48W03P

- AP•T51Z11
- AP•T51X11
- AP•T51Y11
- AP•T51W02
- AP•T51W20
- AP•T51Z02
- AP•T51X12P
- AP•T51X21P
- AP•T51W03P

Limit Switches AP_T series

Double insulation - Plastic casing IP65 - 30 mm. width

Electrical connection:

- AP1:** one cable inlet for PG 13,5 Cable Gland
- AP2:** one cable inlet by 1/2" NPT Plastic Adapter
- AP3:** one cable inlet for PG11 Cable Gland
- AP4:** one cable inlet for M16 x 1,5 Cable Gland
- AP5:** one cable inlet for M20 x 1,5 Cable Gland
- AP6:** 4 poles M12 metal connector
- AP7:** 5 poles M12 metal connector
- AP8:** 8 poles M12 metal connector
- AP9:** 4 poles M12 plastic connector
- AP10:** 5 poles M12 plastic connector
- AP11:** 8 poles M12 plastic connector

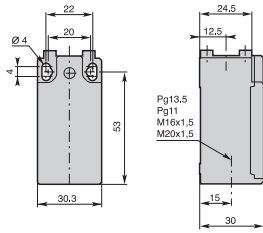

Contact Blocks

Z11 (1NO + 1NC)	AP•T5100Z11	AP•T52Z11	AP•T5200Z11
X11 (1NO + 1NC)	AP•T5100X11	AP•T52X11	AP•T5200X11
Y11 (1NO + 1NC)	AP•T5100Y11	AP•T52Y11	AP•T5200Y11
W02 (2NC)	AP•T5100W02	AP•T52W02	AP•T5200W02
W20 (2NO)	AP•T5100W20	AP•T52W20	AP•T5200W20
Z02 (2NC)	AP•T5100Z02	AP•T52Z02	AP•T5200Z02
X12P (1NO + 2NC)	AP•T5100X12P	AP•T52X12P	AP•T5200X12P
X21P (2NO + 1NC)	AP•T5100X21P	AP•T52X21P	AP•T5200X21P
W03P (3NC)	AP•T5100W03P	AP•T52W03P	AP•T5200W03P

T5100 - Adjustable toothed lever (step 2 mm) with Ø 18 nylon roller

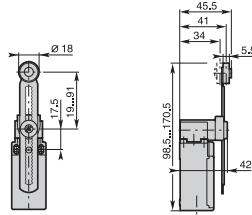

Min. actuating torque **0,10Nm (0,32Nm ⊖)**
Weight **105 g**

T52 - Adjustable lever with Ø 50 rubber roller

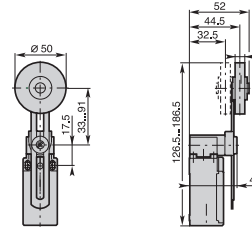

Min. actuating torque **0,10Nm (0,32Nm ⊖)**
Weight **125 g**

T5200 - Adjustable toothed lever (step 2 mm) with Ø 50 rubber roller

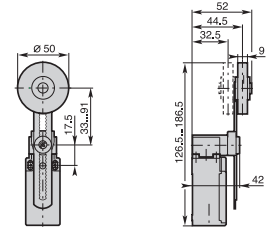

Min. actuating torque **0,10Nm (0,32Nm ⊖)**
Weight **125 g**

T53 - Adjustable lever with Ø 18 metal roller

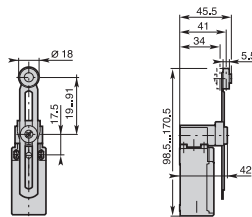

Min. actuating torque **0,10Nm (0,32Nm ⊖)**
Weight **110 g**

T55 - Adjustable lever with adjustable Ø 50 rubber roller

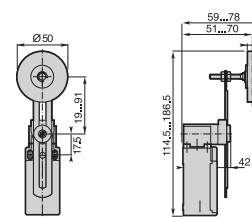

Min. actuating torque **0,10Nm (0,32Nm ⊖)**
Weight **130 g**

T5500 - Adjustable toothed lever (step 2 mm) with adjustable Ø 50 rubber roller

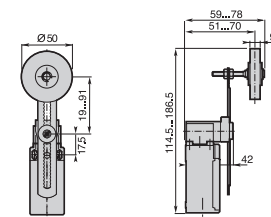

Min. actuating torque **0,10Nm (0,32Nm ⊖)**
Weight **130 g**

Contact Blocks

Z11 (1NO + 1NC)	AP•T53Z11	AP•T55Z11	AP•T5500Z11
X11 (1NO + 1NC)	AP•T53X11	AP•T55X11	AP•T5500X11
Y11 (1NO + 1NC)	AP•T53Y11	AP•T55Y11	AP•T5500Y11
W02 (2NC)	AP•T53W02	AP•T55W02	AP•T5500W02
W20 (2NO)	AP•T53W20	AP•T55W20	AP•T5500W20
Z02 (2NC)	AP•T53Z02	AP•T55Z02	AP•T5500Z02
X12P (1NO + 2NC)	AP•T53X12P	AP•T55X12P	AP•T5500X12P
X21P (2NO + 1NC)	AP•T53X21P	AP•T55X21P	AP•T5500X21P
W03P (3NC)	AP•T53W03P	AP•T55W03P	AP•T5500W03P

Operation diagrams: page 123 - All dimensions are in mm

Limit Switches AP_T series

Double insulation - Plastic casing IP65 - 30 mm. width

Electrical connection:

- AP1: one cable inlet for PG 13,5 Cable Gland
- AP2: one cable inlet by 1/2" NPT Plastic Adapter
- AP3: one cable inlet for PG11 Cable Gland
- AP4: one cable inlet for M16 x 1,5 Cable Gland
- AP5: one cable inlet for M20 x 1,5 Cable Gland
- AP6: 4 poles M12 metal connector
- AP7: 5 poles M12 metal connector
- AP8: 8 poles M12 metal connector
- AP9: 4 poles M12 plastic connector
- AP10: 5 poles M12 plastic connector
- AP11: 8 poles M12 plastic connector

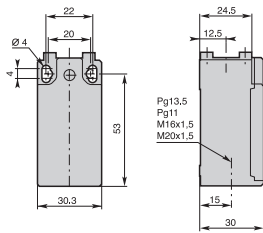

Contact Blocks

- Z11 (1NO + 1NC)
- X11 (1NO + 1NC)
- Y11 (1NO + 1NC)
- W02 (2NC)
- W20 (2NO)
- Z02 (2NC)
- X12P (1NO + 2NC)
- X21P (2NO + 1NC)
- W03P (3NC)

T75 - Adjustable 3x3 square steel rod lever

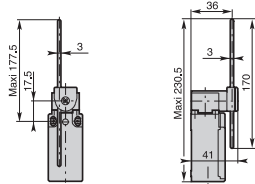

Min. actuating torque 0,10Nm (0,32Nm ⊖)
Weight 105 g

T91 - Stainless steel spring multidirectional actuator

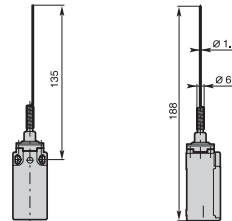

Min. actuating torque 0,12Nm
Weight 80 g

T92 - Multidirectional nylon actuator with stainless steel spring

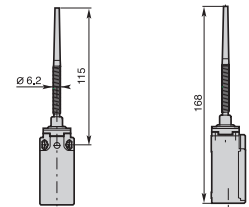

Min. actuating torque 0,12Nm
Weight 85 g

T93 - Stainless steel spring multidirectional actuator

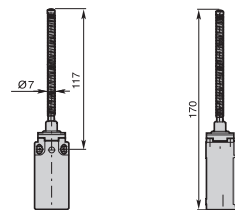

Min. actuating torque 0,12Nm
Weight 90 g

T98 - Pull action with ring

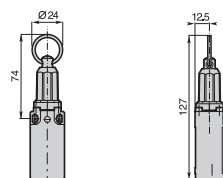

Min. actuating force 15N
Weight 115 g

Contact Blocks

- Z11 (1NO + 1NC)
- X11 (1NO + 1NC)
- Y11 (1NO + 1NC)
- W02 (2NC)
- W20 (2NO)
- Z02 (2NC)
- X12P (1NO + 2NC)
- X21P (2NO + 1NC)
- W03P (3NC)

- AP•T93Z11
- AP•T93X11
- AP•T93Y11
- AP•T93W02
- AP•T93W20
- AP•T93Z02
- AP•T93X12P
- AP•T93X21P
- AP•T93W03P

- AP•T98Z11A
- AP•T98X11A
- AP•T98Y11A
- AP•T98W02A
- AP•T98W20A

Operation diagrams: page 123 - All dimensions are in mm

Limit Switches DP series

Summary

APPROVALS: UL 508 / CSA C22-2 N. 14 / IEC 60947-5-1



CB-SCHEME certification according to IEC 60947-5-1

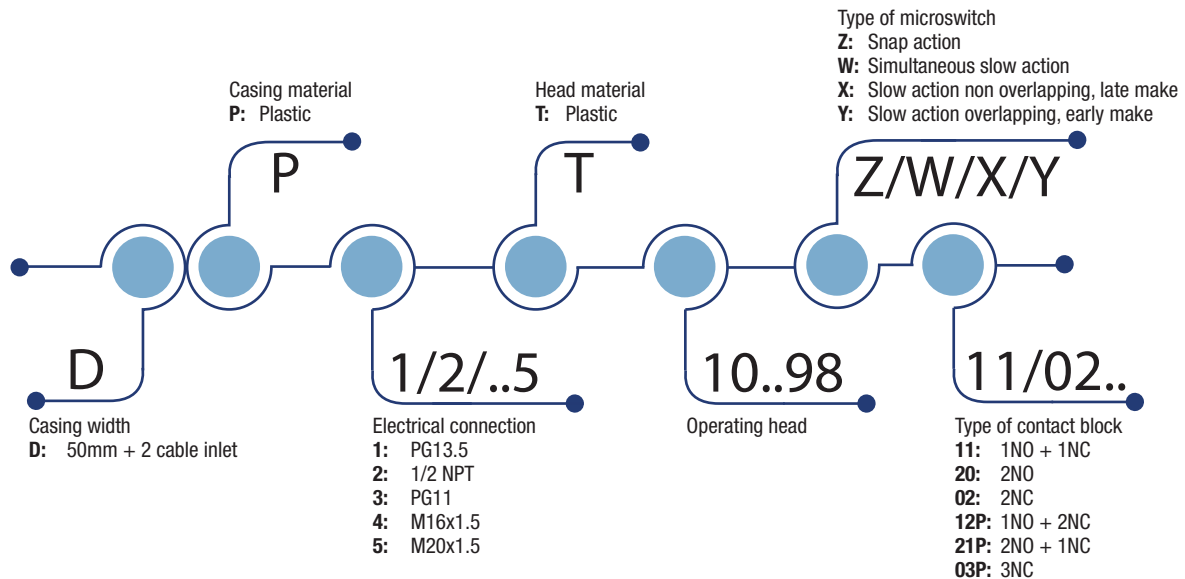

HOW IS IT MADE?

01 A variety of actuators

- Plain plunger
- Roller plunger
- Roller lever, adjustable or not, etc.

02 Wide range of heads

- Assembled using 4 x Ø3 screws

03 Casing:

- 50 mm. width

04 Mounting screws

- 2 or 4 x M4 screws on top part

05 Cover

- 1 screw Ø3 pozidriv 1

06 Contact Block

- Positive opening operation
- Snap action or slow action
- Electrically separated contacts

07 Connecting terminals

- Block of 2 contacts: M3.5 (+, -) pozidriv 2 screw
- Block of 3 contacts: M3 (+, -) screw
- Screw head with captive cable clamp
- Markings conform with IEC 60947-1, IEC 60947-5-1 standards

08 Electrical connection

- 2 x threaded cable inlets suitable for cable gland

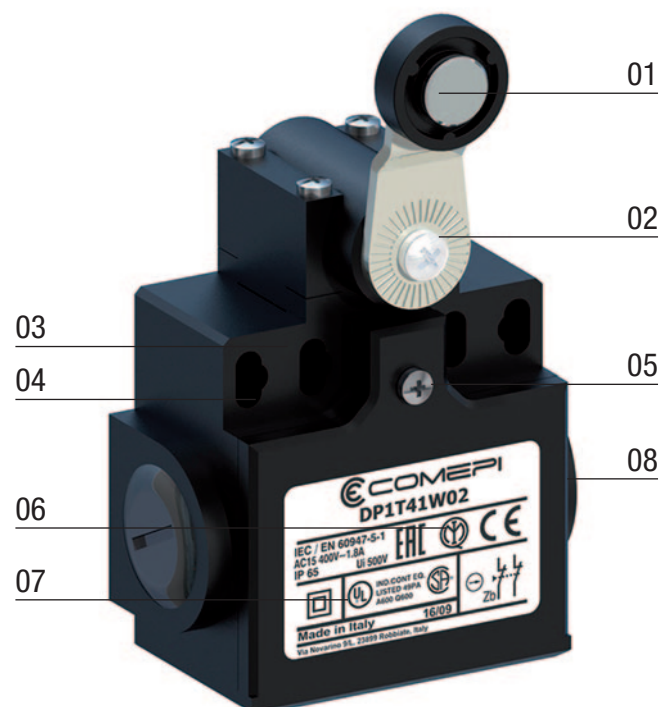

Limit Switches **DP series**

Description

APPLICATIONS

Easy to use, electromechanical limit switches offer specific qualities:

- Visible operation.
- Able to switch strong currents (10 A conventional thermal current).
- Electrically separated contacts.
- Precise operating points (consistency).
- Immune to electromagnetic disturbances.

They are purpose-built detection devices thanks to these characteristics:

- Presence/absence.
- Positioning and travel limit.
- Objects passing/counting.

DESCRIPTION

Limit switches, which are made of reinforced UL-VO thermoplastic fiber-glass, offer double insulation  and a degree of protection of IP65.

They comply with the requirements of European Directives (Low Voltage and RoHS) and are conform to European and International Standards.

The CE declaration of these products are available in the download section of website www.comepi.it or by writing to the following email address: tecnico@comepi.it
DDC02 - Limit Switches.

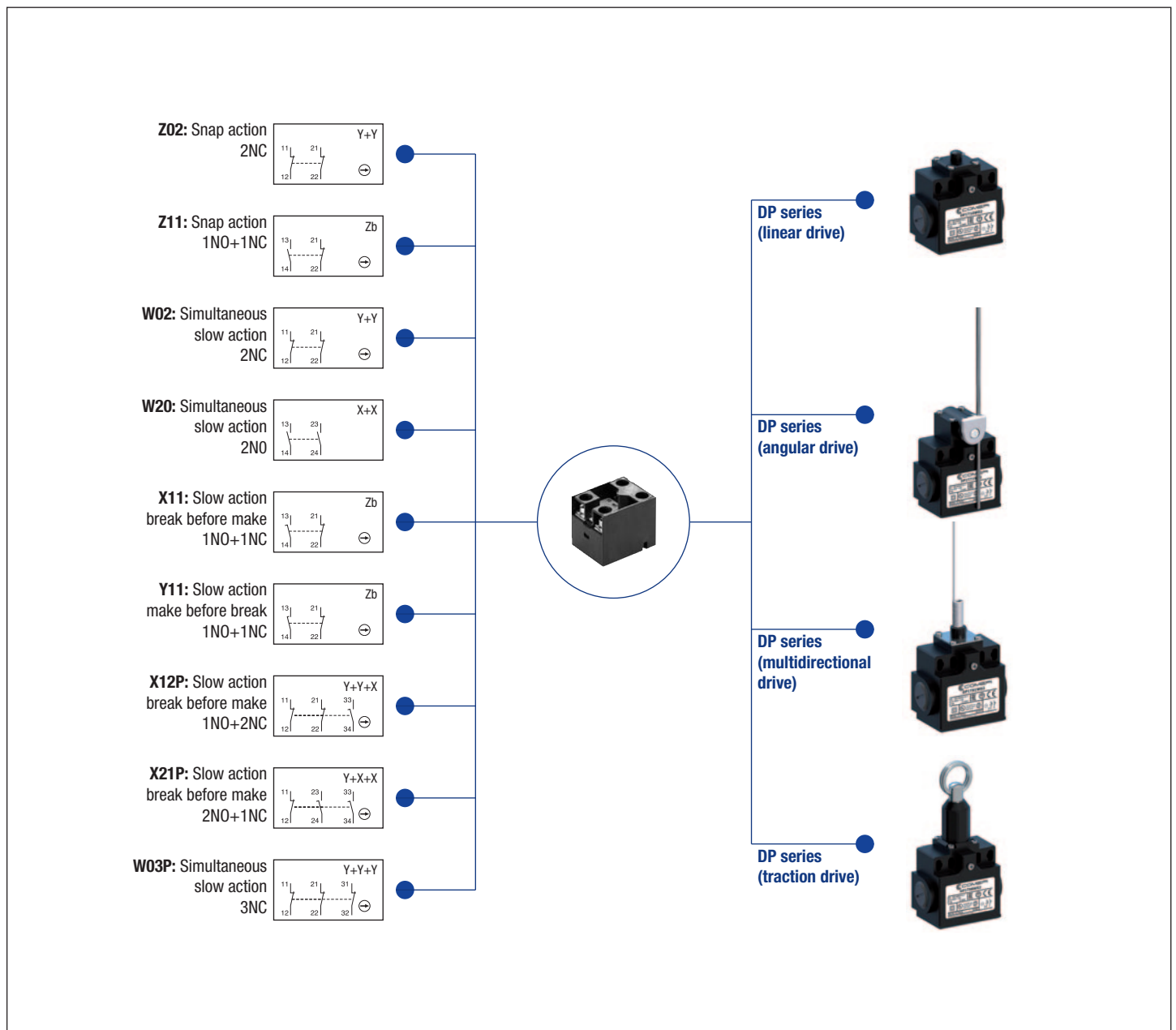

Limit Switches **DP series**

Technical Data

	DP_T Series	
Standards	IEC 60947-5-1 EN 60947-5-1	
Certifications - Approvals	UL - CSA - IMQ - EAC - CCC - UKCA	
Air temperature near the device		
– during operation	°C	– 25 ... + 70
– for storage	°C	– 30 ... + 80
Mounting positions	All positions are authorised	
Protection against electrical shocks (acc. to IEC 61140)	Class II	
Degree of protection (according to IEC 60529 and EN 60529)	IP65 (for all models) - IP67 (only for operating heads from 10 to 39)	

Electrical Data

Rated insulation voltage U_i - according to IEC 60947-1 and EN 60947-1 - according to UL 508 and CSA C22-2 n° 14	500 V (degree of pollution 3) (400 V for contacts type Z02, X12P, X21P, W03P) A 600, Q 600 (A 300, Q 300 for contacts type X12P, X21P, W03P)	
Rated impulse withstand voltage U_{imp} (according to IEC 60947-1 and EN 60947-1)	kV	6
Conventional free air thermal current I_{th} (according to IEC 60947-5-1) $\theta < 40$ °C	A	10
Short-circuit protection $U_e < 500$ V a.c. - gG (gl) type fuses	A	10
Rated operational current I_e / AC-15 (according to IEC 60947-5-1)	24 V - 50/60 Hz A 120 V - 50/60 Hz A 400 V - 50/60 Hz A	10 6 4
I_e / DC-13 (according to IEC 60947-5-1)	24 V - d.c. A 125 V - d.c. A 250 V - d.c. A	6 0.55 0.4
Switching frequency	Cycles/h	3600
Load factor		0.5
Resistance between contacts	m Ω	25
Connecting terminals	M3.5 (+, -) pozidriv 2 screw with cable clamp (M3 for 3 poles contacts type)	
Terminal for protective conductor	-	
Recommended tightening torque	Plastic	
Cover	0,5Nm, max 0,8	
Head	0,5Nm, max 0,8	
Microswitch	0,8Nm, max 0,9	
Connecting capacity	1 or 2 x mm ²	0.34 ... 2.5 (0.34... 1.5 for 3 poles contacts type)
Terminal marking	According to IEC 60947-5-1	
Mechanical durability	15 millions of operations 10 millions of operations >5 millions of operations	T10...12; T21; T2101; T30...34; T38 T13; T41...48; T51...55; T61...75 T14; T35; T36; T39; T91...93; T98
Electrical durability (according to IEC 60947-5-1)	Utilization categories AC-15 and DC-13 (Load factor of 0.5 according to curves below)	

AC-15 - Snap action

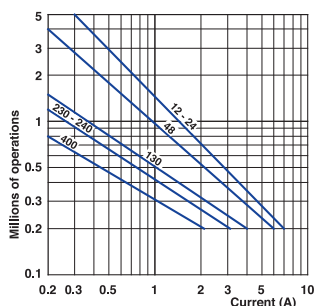

AC-15 - Slow action

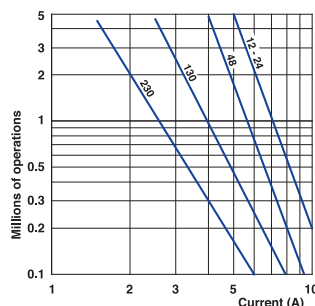

DC-13	Snap action	Slow action
	Power breaking for a durability of 5 million operating cycles	
Voltage 24 V	9.5 W	12 W
Voltage 48 V	6.8 W	9 W
Voltage 110 V	3.6 W	6 W

Limit Switches DP series

Technical Data

Technical data approved by IMQ

Standards	Devices conform with international IEC 60947-5-1 and European EN 60947-5-1 standards	
Degree of protection	IP 65	
Rated insulation voltage U_i	500 V (degree of pollution 3) (400V for type Z02, X12P, X21P, W03P)	
Rated impulse withstand voltage U_{imp}	6 kV	
Conventional free air thermal current I_{th}	10 A	
Short-circuit protection - gG (gl) type fuses	10 A	
Rated operational current		
I_e / AC-15	24 V - 50/60 Hz	10 A
	400 V - 50/60 Hz	4 A
I_e / DC-13	24 V - d.c.	6 A
	125 V - d.c.	0.55 A
	250 V - d.c.	0.4 A

IMPLEMENTATION

Operating head orientation

The head can be rotated each 90°. Recommended tightening torque 0,5 Nm (max 0,8 Nm).

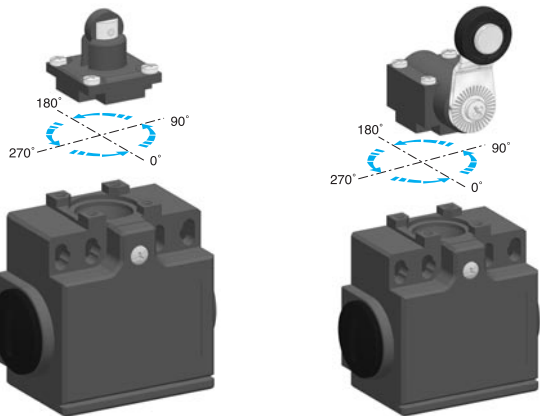

Technical data approved by UL

Standards	Devices conform with UL 508
Contact blocks type Z11, X11, Y11, W02 and Z02	
Utilization categories	A600, Q600
Contact blocks type X12P, X21P and W03P	
Utilization categories	A300, Q300

Use 60/75°C copper (Cu) conductor only. Wire rages 14-18 AWG stranded or solid. The terminal tightening torque of 7 lbs-in / 0.78 Nm. Suitable for conduit connection only with use of adapter sleeve optionally provided or recommended by the manufacturer.

For the complete list of approved products, contact our technical department

Lever adjustment

The lever of the angular actuators can be adjusted every 10° and round turned in order to obtain the maximum flexibility on the working plan. Recommended tightening torque 0,5 Nm (max 0,8 Nm).

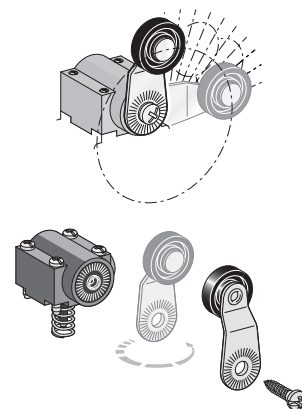

Special Versions

Metal actuators

The operating heads used in plastic limit switches AP and DP series have the same dimensions of the ones used in the corresponding metal AM and DM series. It is therefore possible to supply "mixed" versions, that is:

- plastic operating head on metal casing
- metal operating head on plastic casing

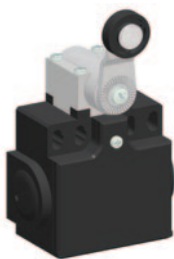

Low Temperature

The limit switches for low temperature applications are useful for refrigerated cells or equipments where the air operational temperature is very low. These devices, made in special materials, are able to extend the operational temperature range down to -40°C, maintaining mechanical performances intact.

To order add the digits "40" following the operating head indication in part number.

For example: DP1T10Z11 → DP1T1040Z11

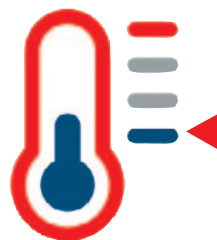

Manual reset operating head

Limit switches equipped with special operating head with manual reset button.

For more information:



For further informations, please contact our technical department.

Limit Switches DP_T series

Double insulation - Plastic casing IP65 - 50 mm. width

Electrical connection:

- DP1:** two cable inlets for PG 13,5 Cable Gland
- DP2:** two cable inlets for PG11 Cable Gland with one plastic adapter PG11 - 1/2" NPT
- DP3:** two cable inlets for PG11 Cable Gland
- DP4:** two cable inlets for M16 x 1,5 Cable Gland
- DP5:** two cable inlets for M20 x 1,5 Cable Gland

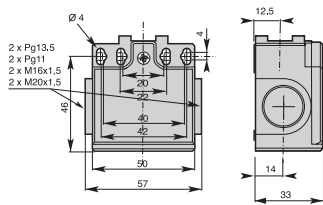

T10 - Plain nylon plunger

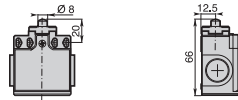

Min. actuating force
Weight 15N (30N ⊖)
100 g

T11 - Plain metal plunger

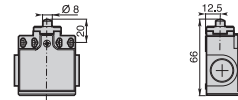

Min. actuating force
Weight 15N (30N ⊖)
100 g

T12 - Metal roller plunger

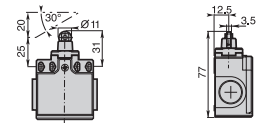

Min. actuating force
Weight 12N (30N ⊖)
105 g

Contact Blocks

Z11 (1NO + 1NC)	DP•T10Z11	DP•T11Z11	DP•T12Z11
X11 (1NO + 1NC)	DP•T10X11	DP•T11X11	DP•T12X11
Y11 (1NO + 1NC)	DP•T10Y11	DP•T11Y11	DP•T12Y11
W02 (2NC)	DP•T10W02	DP•T11W02	DP•T12W02
W20 (2NO)	DP•T10W20	DP•T11W20	DP•T12W20
Z02 (2NC)	DP•T10Z02	DP•T11Z02	DP•T12Z02
X12P (1NO + 2NC)	DP•T10X12P	DP•T11X12P	DP•T12X12P
X21P (2NO + 1NC)	DP•T10X21P	DP•T11X21P	DP•T12X21P
W03P (3NC)	DP•T10W03P	DP•T11W03P	DP•T12W03P

T13 - Nylon roller plunger

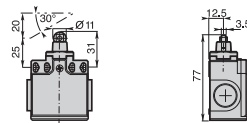

Min. actuating force
Weight 12N (30N ⊖)
105 g

T14 - Metal plunger with dust protection cup

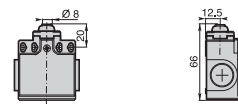

Min. actuating force
Weight 15N (30N ⊖)
100 g

T21 - Plain plunger with M18x fixing nuts

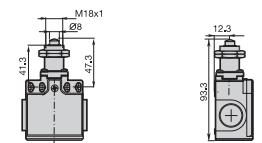

Min. actuating force
Weight 15N (30N ⊖)
110 g

Contact Blocks

Z11 (1NO + 1NC)	DP•T13Z11	DP•T14Z11	DP•T21Z11
X11 (1NO + 1NC)	DP•T13X11	DP•T14X11	DP•T21X11
Y11 (1NO + 1NC)	DP•T13Y11	DP•T14Y11	DP•T21Y11
W02 (2NC)	DP•T13W02	DP•T14W02	DP•T21W02
W20 (2NO)	DP•T13W20	DP•T14W20	DP•T21W20
Z02 (2NC)	DP•T13Z02	DP•T14Z02	DP•T21Z02
X12P (1NO + 2NC)	DP•T13X12P	DP•T14X12P	DP•T21X12P
X21P (2NO + 1NC)	DP•T13X21P	DP•T14X21P	DP•T21X21P
W03P (3NC)	DP•T13W03P	DP•T14W03P	DP•T21W03P

Operation diagrams: page 123 - All dimensions are in mm

Limit Switches DP_T series

Double insulation - Plastic casing IP65 - 50 mm. width

Electrical connection:

- DP1:** two cable inlets for PG 13,5 Cable Gland
- DP2:** two cable inlets for PG11 Cable Gland with one plastic adapter PG11 - 1/2" NPT
- DP3:** two cable inlets for PG11 Cable Gland
- DP4:** two cable inlets for M16 x 1,5 Cable Gland
- DP5:** two cable inlets for M20 x 1,5 Cable Gland

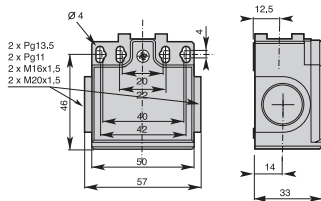

Contact Blocks

Z11 (1NO + 1NC)	DP•T2101Z11	DP•T30Z11	DP•T31Z11
X11 (1NO + 1NC)	DP•T2101X11	DP•T30X11	DP•T31X11
Y11 (1NO + 1NC)	DP•T2101Y11	DP•T30Y11	DP•T31Y11
W02 (2NC)	DP•T2101W02	DP•T30W02	DP•T31W02
W20 (2NO)	DP•T2101W20	DP•T30W20	DP•T31W20
Z02 (2NC)	DP•T2101Z02	DP•T30Z02	DP•T31Z02
X12P (1NO + 2NC)	DP•T2101X12P	DP•T30X12P	DP•T31X12P
X21P (2NO + 1NC)	DP•T2101X21P	DP•T30X21P	DP•T31X21P
W03P (3NC)	DP•T2101W03P	DP•T30W03P	DP•T31W03P

T2101 - Plain plunger with M12x1 fixing nuts

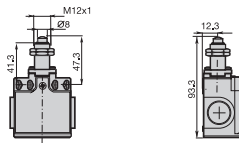

Min. actuating force
Weight

15N (30N ⇄)
110 g

T30 - Plastic roller lever on plastic plunger

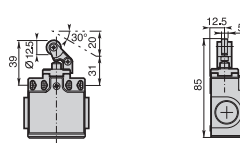

Min. actuating force
Weight

7N (24N ⇄)
105 g

T31 - Plastic roller lever on metal plunger

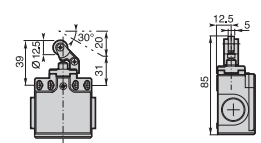

Min. actuating force
Weight

7N (24N ⇄)
105 g

T35 - Plastic roller lever on metal plunger with dust protection cup

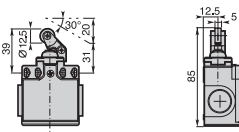

Min. actuating force
Weight

7N (24N ⇄)
105 g

T38 - Adjustable plastic roller lever on metal plunger

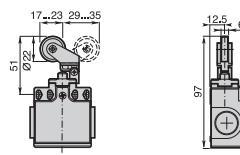

Min. actuating force
Weight

7N (24N ⇄)
110 g

T39 - Adjustable plastic roller lever on metal plunger with dust protection cup

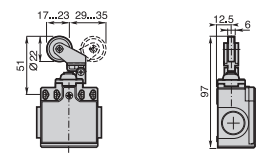

Min. actuating force
Weight

7N (24N ⇄)
110 g

Contact Blocks

Z11 (1NO + 1NC)	DP•T35Z11	DP•T38Z11	DP•T39Z11
X11 (1NO + 1NC)	DP•T35X11	DP•T38X11	DP•T39X11
Y11 (1NO + 1NC)	DP•T35Y11	DP•T38Y11	DP•T39Y11
W02 (2NC)	DP•T35W02	DP•T38W02	DP•T39W02
W20 (2NO)	DP•T35W20	DP•T38W20	DP•T39W20
Z02 (2NC)	DP•T35Z02	DP•T38Z02	DP•T39Z02
X12P (1NO + 2NC)	DP•T35X12P	DP•T38X12P	DP•T39X12P
X21P (2NO + 1NC)	DP•T35X21P	DP•T38X21P	DP•T39X21P
W03P (3NC)	DP•T35W03P	DP•T38W03P	DP•T39W03P

Operation diagrams: page 123 - All dimensions are in mm

Limit Switches DP_T series

Double insulation - Plastic casing IP65 - 50 mm. width

Electrical connection:

- DP1:** two cable inlets for PG 13,5 Cable Gland
DP2: two cable inlets for PG11 Cable Gland with one plastic adapter PG11 - 1/2" NPT
DP3: two cable inlets for PG11 Cable Gland
DP4: two cable inlets for M16 x 1,5 Cable Gland
DP5: two cable inlets for M20 x 1,5 Cable Gland

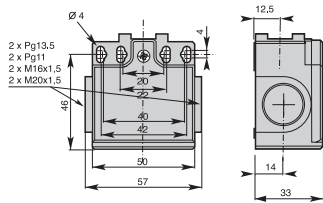

T41 - Ø 18 nylon roller lever

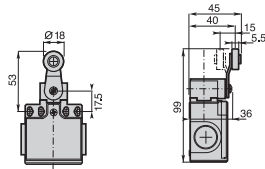

Min. actuating torque 0,10Nm (0,32Nm ⊖)
 Weight 125 g

T42 - Ø 50 rubber roller lever

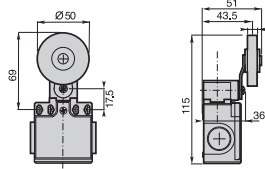

Min. actuating torque 0,10Nm (0,32Nm ⊖)
 Weight 145 g

T43 - Ø 18 metal roller lever

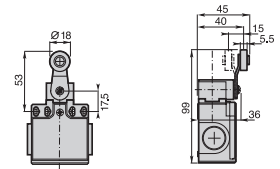

Min. actuating torque 0,10Nm (0,32Nm ⊖)
 Weight 130 g

Contact Blocks

Z11 (1NO + 1NC)	DP•T41Z11	DP•T42Z11	DP•T43Z11
X11 (1NO + 1NC)	DP•T41X11	DP•T42X11	DP•T43X11
Y11 (1NO + 1NC)	DP•T41Y11	DP•T42Y11	DP•T43Y11
W02 (2NC)	DP•T41W02	DP•T42W02	DP•T43W02
W20 (2NO)	DP•T41W20	DP•T42W20	DP•T43W20
Z02 (2NC)	DP•T41Z02	DP•T42Z02	DP•T43Z02
X12P (1NO + 2NC)	DP•T41X12P	DP•T42X12P	DP•T43X12P
X21P (2NO + 1NC)	DP•T41X21P	DP•T42X21P	DP•T43X21P
W03P (3NC)	DP•T41W03P	DP•T42W03P	DP•T43W03P

T45 - Ø 18 nylon roller lever

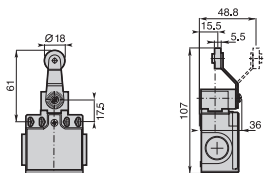

Min. actuating torque 0,10Nm (0,32Nm ⊖)
 Weight 125 g

T46 - Ø 18 metal roller lever

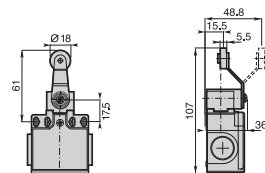

Min. actuating torque 0,10Nm (0,32Nm ⊖)
 Weight 130 g

T48 - Ceramic rod lever

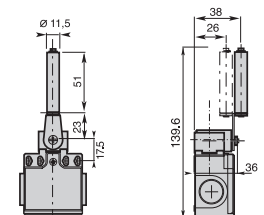

Min. actuating torque 0,10Nm (0,32Nm ⊖)
 Weight 130 g

Contact Blocks

Z11 (1NO + 1NC)	DP•T45Z11	DP•T46Z11	DP•T48Z11
X11 (1NO + 1NC)	DP•T45X11	DP•T46X11	DP•T48X11
Y11 (1NO + 1NC)	DP•T45Y11	DP•T46Y11	DP•T48Y11
W02 (2NC)	DP•T45W02	DP•T46W02	DP•T48W02
W20 (2NO)	DP•T45W20	DP•T46W20	DP•T48W20
Z02 (2NC)	DP•T45Z02	DP•T46Z02	DP•T48Z02
X12P (1NO + 2NC)	DP•T45X12P	DP•T46X12P	DP•T48X12P
X21P (2NO + 1NC)	DP•T45X21P	DP•T46X21P	DP•T48X21P
W03P (3NC)	DP•T45W03P	DP•T46W03P	DP•T48W03P

Operation diagrams: page 123 - All dimensions are in mm

Limit Switches DP_T series

Double insulation - Plastic casing IP65 - 50 mm. width

Electrical connection:

- DP1:** two cable inlets for PG 13,5 Cable Gland
- DP2:** two cable inlets for PG11 Cable Gland with one plastic adapter PG11 - 1/2" NPT
- DP3:** two cable inlets for PG11 Cable Gland
- DP4:** two cable inlets for M16 x 1,5 Cable Gland
- DP5:** two cable inlets for M20 x 1,5 Cable Gland

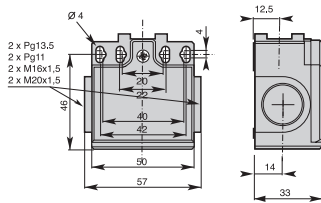

Contact Blocks

- Z11** (1NO + 1NC)
- X11** (1NO + 1NC)
- Y11** (1NO + 1NC)
- W02** (2NC)
- W20** (2NO)
- Z02** (2NC)
- X12P** (1NO + 2NC)
- X21P** (2NO + 1NC)
- W03P** (3NC)

T51 - Adjustable lever with Ø 18 nylon roller

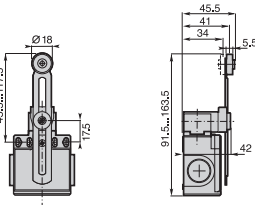

Min. actuating torque **0,10Nm (0,32Nm ⊖)**
Weight **135 g**

T5100 - Adjustable toothed lever (step 2 mm) with Ø 18 nylon roller

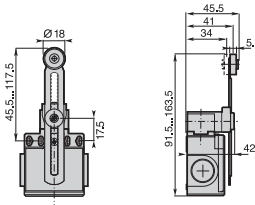

Min. actuating torque **0,10Nm (0,32Nm ⊖)**
Weight **135 g**

T52 - Adjustable lever with Ø 50 rubber roller

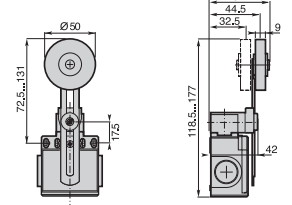

Min. actuating torque **0,10Nm (0,32Nm ⊖)**
Weight **155 g**

T5200 - Adjustable toothed lever (step 2 mm) with Ø 50 rubber roller

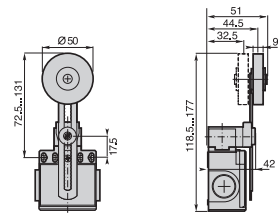

Min. actuating torque **0,10Nm (0,32Nm ⊖)**
Weight **155 g**

T53 - Adjustable lever with Ø 18 metal roller

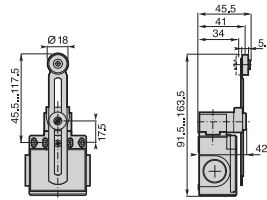

Min. actuating torque **0,10Nm (0,32Nm ⊖)**
Weight **140 g**

T55 - Adjustable lever with adjustable Ø 50 rubber roller

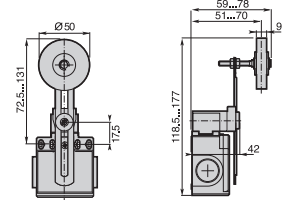

Min. actuating torque **0,10Nm (0,32Nm ⊖)**
Weight **155 g**

Contact Blocks

- Z11** (1NO + 1NC)
- X11** (1NO + 1NC)
- Y11** (1NO + 1NC)
- W02** (2NC)
- W20** (2NO)
- Z02** (2NC)
- X12P** (1NO + 2NC)
- X21P** (2NO + 1NC)
- W03P** (3NC)

- DP•T51Z11**
- DP•T51X11**
- DP•T51Y11**
- DP•T51W02**
- DP•T51W20**
- DP•T51Z02**
- DP•T51X12P**
- DP•T51X21P**
- DP•T51W03P**

- DP•T5100Z11**
- DP•T5100X11**
- DP•T5100Y11**
- DP•T5100W02**
- DP•T5100W20**
- DP•T5100Z02**
- DP•T5100X12P**
- DP•T5100X21P**
- DP•T5100W03P**

- DP•T52Z11**
- DP•T52X11**
- DP•T52Y11**
- DP•T52W02**
- DP•T52W20**
- DP•T52Z02**
- DP•T52X12P**
- DP•T52X21P**
- DP•T52W03P**

Operation diagrams: page 123 - All dimensions are in mm

Limit Switches DP_T series

Double insulation - Plastic casing IP65 - 50 mm. width

Electrical connection:

- DP1:** two cable inlets for PG 13,5 Cable Gland
DP2: two cable inlets for PG11 Cable Gland with one plastic adapter PG11 - 1/2" NPT
DP3: two cable inlets for PG11 Cable Gland
DP4: two cable inlets for M16 x 1,5 Cable Gland
DP5: two cable inlets for M20 x 1,5 Cable Gland

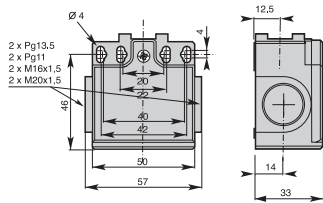

T5500 - Adjustable toothed lever (step 2 mm) with adjustable Ø 50 rubber roller

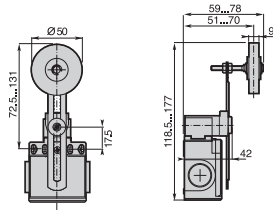

Min. actuating torque **0,10Nm (0,32Nm)**
 Weight **155 g**

T61 - Nylon actuator with stainless steel spring

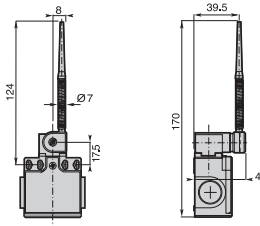

Min. actuating torque **0,10Nm**
 Weight **135 g**

T62 - Stainless steel spring actuator

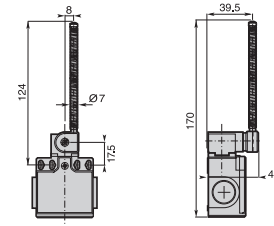

Min. actuating torque **0,10Nm**
 Weight **135 g**

Contact Blocks

Z11 (1NO + 1NC)	DP•T5500Z11	DP•T61Z11	DP•T62Z11
X11 (1NO + 1NC)	DP•T5500X11	DP•T61X11	DP•T62X11
Y11 (1NO + 1NC)	DP•T5500Y11	DP•T61Y11	DP•T62Y11
W02 (2NC)	DP•T5500W02	DP•T61W02	DP•T62W02
W20 (2NO)	DP•T5500W20	DP•T61W20	DP•T62W20
Z02 (2NC)	DP•T5500Z02	DP•T61Z02	DP•T62Z02
X12P (1NO + 2NC)	DP•T5500X12P	DP•T61X12P	DP•T62X12P
X21P (2NO + 1NC)	DP•T5500X21P	DP•T61X21P	DP•T62X21P
W03P (3NC)	DP•T5500W03P	DP•T61W03P	DP•T62W03P

T71 - Adjustable Ø 3 rod lever with stainless steel rod

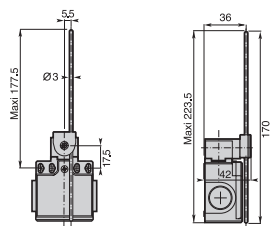

Min. actuating torque **0,10Nm (0,32Nm)**
 Weight **130 g**

T72 - Adjustable Ø 3 rod lever with fiberglass rod

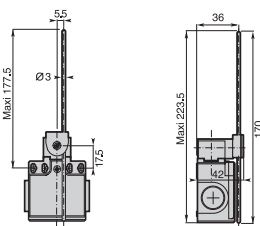

Min. actuating torque **0,10Nm (0,32Nm)**
 Weight **130 g**

T73 - Adjustable Ø 6 rod lever with nylon rod

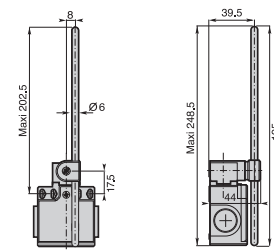

Min. actuating torque **0,10Nm (0,32Nm)**
 Weight **145 g**

Contact Blocks

Z11 (1NO + 1NC)	DP•T71Z11	DP•T72Z11	DP•T73Z11
X11 (1NO + 1NC)	DP•T71X11	DP•T72X11	DP•T73X11
Y11 (1NO + 1NC)	DP•T71Y11	DP•T72Y11	DP•T73Y11
W02 (2NC)	DP•T71W02	DP•T72W02	DP•T73W02
W20 (2NO)	DP•T71W20	DP•T72W20	DP•T73W20
Z02 (2NC)	DP•T71Z02	DP•T72Z02	DP•T73Z02
X12P (1NO + 2NC)	DP•T71X12P	DP•T72X12P	DP•T73X12P
X21P (2NO + 1NC)	DP•T71X21P	DP•T72X21P	DP•T73X21P
W03P (3NC)	DP•T71W03P	DP•T72W03P	DP•T73W03P

Operation diagrams: page 123 - All dimensions are in mm

Limit Switches **AM series**

Summary

APPROVALS: UL 508 / CSA C22-2 N. 14 / IEC 60947-5-1



CB-SCHEME certification according to IEC 60947-5-1

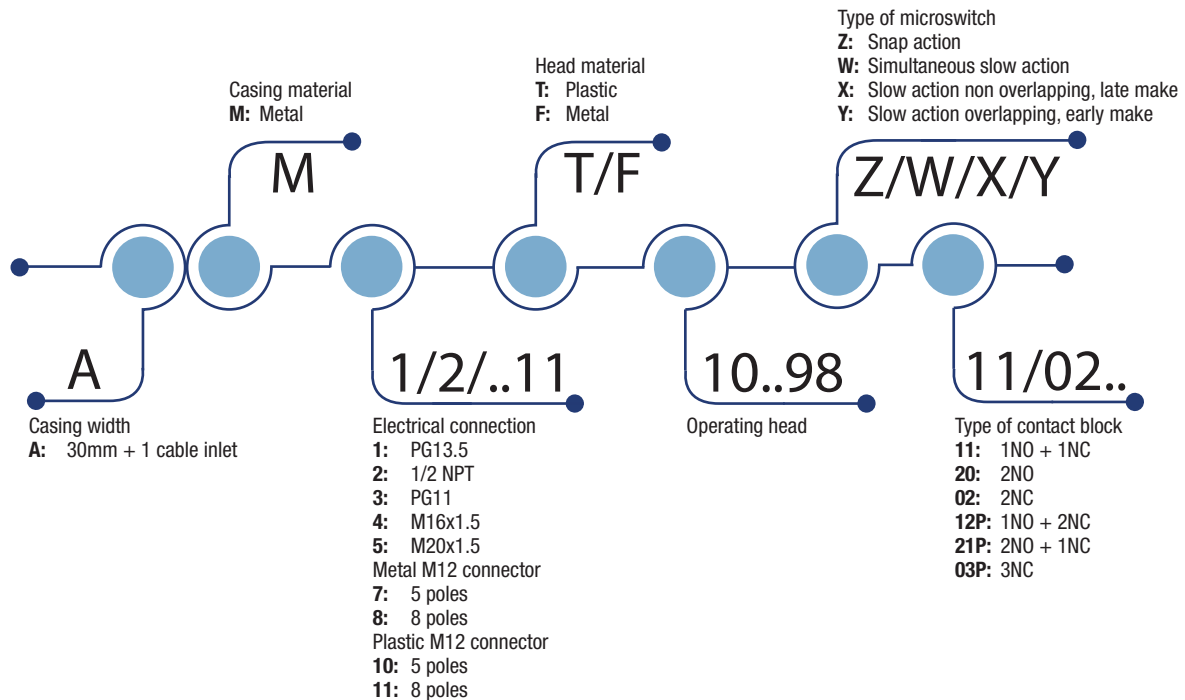

HOW IS IT MADE?

01 A variety of actuators

- Plain plunger
- Roller plunger
- Roller lever, adjustable or not, etc.

02 Wide range of heads

- Assembled using 4 x Ø3 screws

03 Casing:

- 30 mm. width with standardized dimensions acc. to EN 50047

04 Mounting screws

- 2 or 4 x M4 screws on top part

05 Cover

- 3 screws Ø3 pozidriv 1

06 Contact Block

- Positive opening operation
- Snap action or slow action
- Electrically separated contacts

07 Connecting terminals

- Block of 2 contacts: M3.5 (+, -) pozidriv 2 screw
- Block of 3 contacts: M3 (+, -) screw
- Screw head with captive cable clamp
- Markings conform with IEC 60947-1, IEC 60947-5-1 standards

08 Electrical connection

- 1 x threaded cable entry suitable for cable gland, M12 connector or DEUTSCH connector

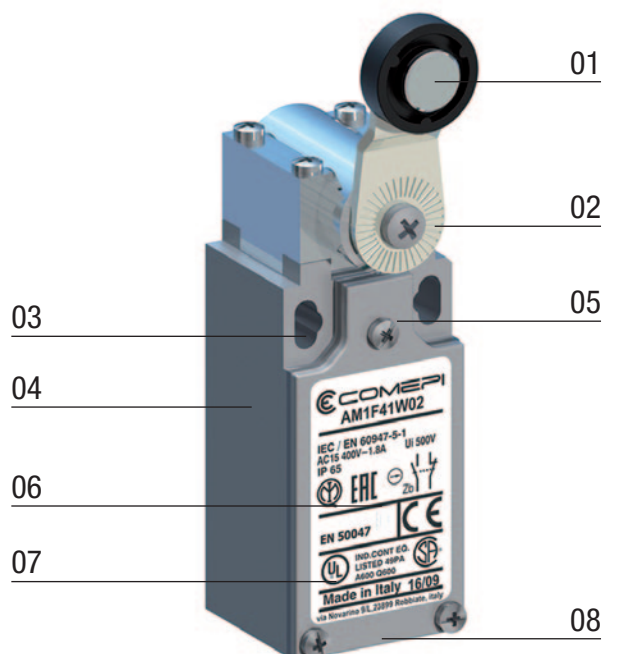

Limit Switches **AM series**

Description

APPLICATIONS

Easy to use, electromechanical limit switches offer specific qualities:

- Visible operation.
- Able to switch strong currents (10 A conventional thermal current).
- Electrically separated contacts.
- Precise operating points (consistency).
- Immune to electromagnetic disturbances.

They are purpose-built detection devices thanks to these characteristics:

- Presence/absence.
- Positioning and travel limit.
- Objects passing/counting.

DESCRIPTION

Limit switches, which are made of zinc alloy (Zamak), offer a degree of protection of IP66.

They comply with the requirements of European Directives (Low Voltage and RoHS) and are conform to European and International Standards.

The CE declaration of these products are available in the download section of website www.comepi.it or by writing to the following email address: tecnico@comepi.it
DDC02 - Limit Switches.

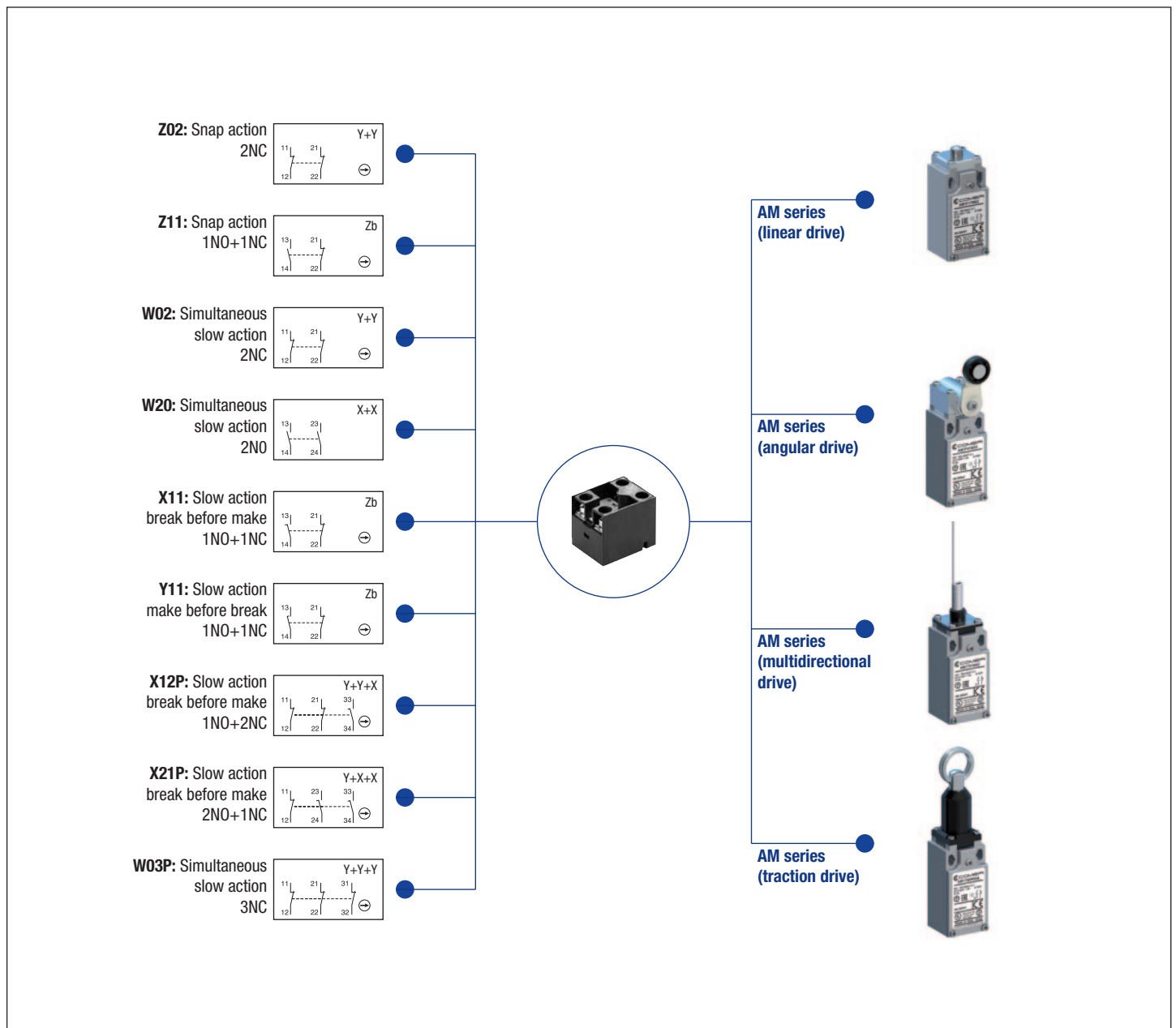

Limit Switches **AM series**

Technical Data

	AM Series	
Standards	IEC 60947-5-1 EN 60947-5-1	
Certifications - Approvals	UL - CSA - IMQ - EAC - CCC - UKCA	
Air temperature near the device		
– during operation	°C	– 25 ... + 70
– for storage	°C	– 30 ... + 80
Mounting positions	All positions are authorised	
Protection against electrical shocks (acc. to IEC 61140)	Class I	
Degree of protection (according to IEC 60529 and EN 60529)	IP 66*	

Electrical Data

Rated insulation voltage U_i - according to IEC 60947-1 and EN 60947-1 - according to UL 508 and CSA C22-2 n° 14	500 V (degree of pollution 3) (400 V for contacts type Z02, X12P, X21P, W03P) A 300, Q 300	
Rated impulse withstand voltage U_{imp} (according to IEC 60947-1 and EN 60947-1)	kV	6
Conventional free air thermal current I_{th} (according to IEC 60947-5-1) $\theta < 40$ °C	A	10
Short-circuit protection $U_e < 500$ V a.c. - gG (gl) type fuses	A	10
Rated operational current I_e / AC-15 (according to IEC 60947-5-1)	24 V - 50/60 Hz A 120 V - 50/60 Hz A 400 V - 50/60 Hz A	10 6 4
I_e / DC-13 (according to IEC 60947-5-1)	24 V - d.c. A 125 V - d.c. A 250 V - d.c. A	6 0.55 0.4
Switching frequency	Cycles/h	3600
Load factor		0.5
Resistance between contacts	m Ω	25
Connecting terminals	M3.5 (+, -) pozidriv 2 screw with cable clamp (M3 for 3 poles contacts type)	
Terminal for protective conductor	M3.5 (+, -) pozidriv 2 screw with cable clamp	
Recommended tightening torque	Metal	
Cover	0,8Nm, max 0,9	
Head	0,8Nm, max 0,9	
Microswitch	0,8Nm, max 0,9	
Connecting capacity	1 or 2 x mm ²	0.34 ... 2.5 (0.34... 1.5 for 3 poles contacts type)
Terminal marking	According to IEC 60947-5-1	
Mechanical durability	15 millions of operations F11; F12; T21; T2101; T30...34; T38 10 millions of operations F41...46; F51...56; F61...75 >5 millions of operations T14; T35; T36; T39; T91...93; T98	
Electrical durability (according to IEC 60947-5-1)	Utilization categories AC-15 and DC-13 (Load factor of 0.5 according to curves below)	

* except for F52, F5200, F55, F5500, F73, F74, T92, T93: the degree of protection is IP65

AC-15 - Snap action

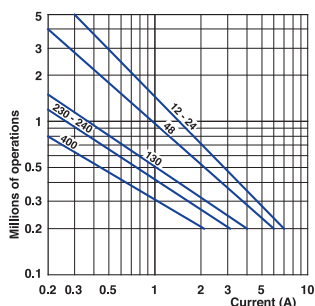

AC-15 - Slow action

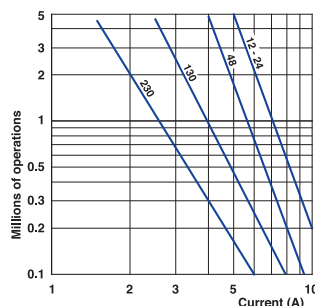

DC-13	Snap action	Slow action
	Power breaking for a durability of 5 million operating cycles	
Voltage 24 V	9.5 W	12 W
Voltage 48 V	6.8 W	9 W
Voltage 110 V	3.6 W	6 W

Limit Switches **AM series**

Technical Data

Technical data approved by IMQ

Standards	Devices conform with international IEC 60947-5-1 and European EN 60947-5-1 standards	
Degree of protection	IP 66*	
Rated insulation voltage U_i	500 V (degree of pollution 3) (400V for type Z02, X12P, X21P, W03P)	
Rated impulse withstand voltage U_{imp}	6 kV	
Conventional free air thermal current I_{th}	10 A	
Short-circuit protection - gG (gI) type fuses	10 A	
Rated operational current		
I_e / AC-15	24 V - 50/60 Hz	10 A
	400 V - 50/60 Hz	4 A
I_e / DC-13	24 V - d.c.	6 A
	125 V - d.c.	0.55 A
	250 V - d.c.	0.4 A

* except for F52, F5200, F55, F5500, F73, F74, T92, T93: the degree of protection is IP65

Technical data approved by UL

Standards	Devices conform with UL 508
Contact blocks type Z11, X11, Y11, W02 and Z02	
Utilization categories	A300, Q300
Contact blocks type X12P, X21P and W03P	
Utilization categories	A300, Q300

Use 60/75°C copper (Cu) conductor only. Wire rages 14-18 AWG stranded or solid. The terminal tightening torque of 7 lbs-in / 0.78 Nm. Suitable for conduit connection only with use of adapter sleeve optionally provided or recommended by the manufacturer.

For the complete list of approved products, contact our technical department

IMPLEMENTATION

Operating head orientation

The head can be rotated each 90°. Recommended tightening torque 0,5 Nm (max 0,8 Nm).

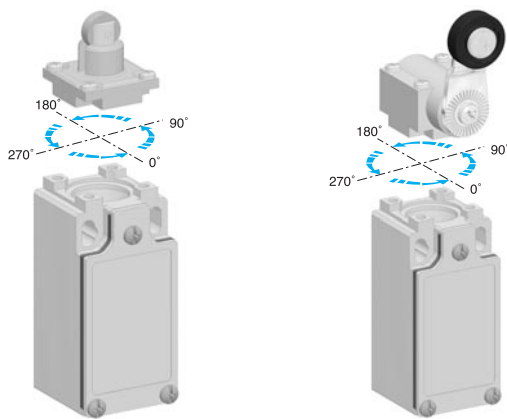

Lever adjustment

The lever of the angular actuators can be adjusted every 10° and round turned in order to obtain the maximum flexibility on the working plan. Recommended tightening torque 0,5 Nm (max 0,8 Nm).

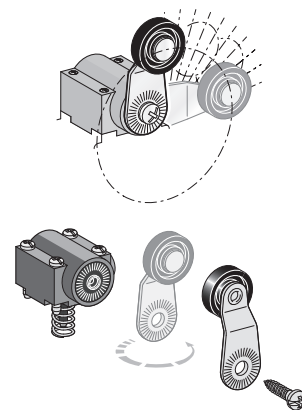

Special Versions

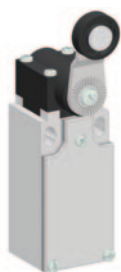

Plastic actuators

The operating heads used in plastic limit switches AP and DP series have the same dimensions of the ones used in the corresponding metal AM and DM series. It is therefore possible to supply "mixed" versions, that is:

- plastic operating head on metal casing
- metal operating head on plastic casing

Manual reset operating head

Limit switches equipped with special operating head with manual reset button.

For more information:

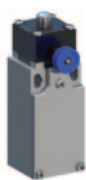

For further informations, please contact our technical department.

Low Temperature

The limit switches for low temperature applications are useful for refrigerated cells or equipments where the air operational temperature is very low. These devices, made in special materials, are able to extend the operational temperature range down to -40°C, maintaining mechanical performances intact.

To order add the digits "40" following the operating head indication in part number.

For example: AM1F11Z11 → AM1F1140Z11

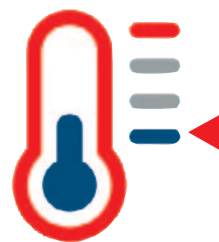

Limit Switches **AM_F/AM_T** series

Metal casing IP66 - 30 mm. width

Electrical connection:

- AM1:** one cable inlet for PG 13,5 Cable Gland
- AM2:** one cable inlet by 1/2" NPT Plastic Adapter
- AM3:** one cable inlet for PG11 Cable Gland
- AM4:** one cable inlet for M16 x 1,5 Cable Gland
- AM5:** one cable inlet for M20 x 1,5 Cable Gland
- AM7:** 5 poles M12 metal connector
- AM8:** 8 poles M12 metal connector
- AM10:** 5 poles M12 plastic connector
- AM11:** 8 poles M12 plastic connector

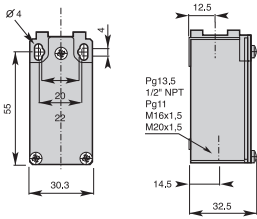

Contact Blocks

- Z11** (1NO + 1NC)
- X11** (1NO + 1NC)
- Y11** (1NO + 1NC)
- W02** (2NC)
- W20** (2NO)
- Z02** (2NC)
- X12P** (1NO + 2NC)
- X21P** (2NO + 1NC)
- W03P** (3NC)

F11 - Plain Metal plunger



Conformity EN50047
Min. actuating force
Weight

15N (30N ⇄)
180 g

F12 - Metal roller plunger

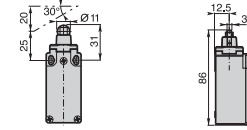

Conformity EN50047
Min. actuating force
Weight

12N (30N ⇄)
190 g

T14 - Metal plunger with dust protection cup

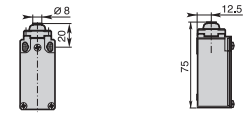

Conformity EN50047
Min. actuating force
Weight

15N (30N ⇄)
165 g

T21 - Plain plunger with M18x1 fixing nuts

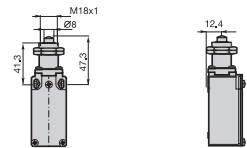

Min. actuating force
Weight

15N (30N ⇄)
175 g

T2101 - Plain plunger with M12x1 fixing nuts

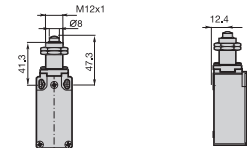

Min. actuating force
Weight

15N (30N ⇄)
175 g

T3 - Plastic roller lever

T30: on plastic plunger T31: on metal plunger

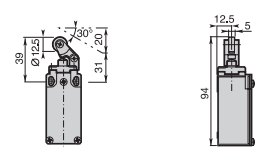
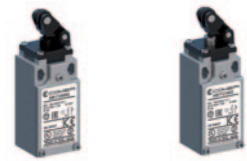

Conformity EN50047
Min. actuating force
Weight

7N (24N ⇄)
170 g

Contact Blocks

- Z11** (1NO + 1NC)
- X11** (1NO + 1NC)
- Y11** (1NO + 1NC)
- W02** (2NC)
- W20** (2NO)
- Z02** (2NC)
- X12P** (1NO + 2NC)
- X21P** (2NO + 1NC)
- W03P** (3NC)

- AM•T21Z11
- AM•T21X11
- AM•T21Y11
- AM•T21W02
- AM•T21W20
- AM•T21Z02
- AM•T21X12P
- AM•T21X21P
- AM•T21W03P

- AM•T2101Z11
- AM•T2101X11
- AM•T2101Y11
- AM•T2101W02
- AM•T2101W20
- AM•T2101Z02
- AM•T2101X12P
- AM•T2101X21P
- AM•T2101W03P

- AM•T30Z11
- AM•T30X11
- AM•T30Y11
- AM•T30W02
- AM•T30W20
- AM•T30Z02
- AM•T30X12P
- AM•T30X21P
- AM•T30W03P

- AM•T31Z11
- AM•T31X11
- AM•T31Y11
- AM•T31W02
- AM•T31W20
- AM•T31Z02
- AM•T31X12P
- AM•T31X21P
- AM•T31W03P

Limit Switches **AM_F/AM_T** series

Metal casing IP66 - 30 mm. width

Electrical connection:

- AM1:** one cable inlet for PG 13,5 Cable Gland
- AM2:** one cable inlet by 1/2" NPT Plastic Adapter
- AM3:** one cable inlet for PG11 Cable Gland
- AM4:** one cable inlet for M16 x 1,5 Cable Gland
- AM5:** one cable inlet for M20 x 1,5 Cable Gland
- AM7:** 5 poles M12 metal connector
- AM8:** 8 poles M12 metal connector
- AM10:** 5 poles M12 plastic connector
- AM11:** 8 poles M12 plastic connector

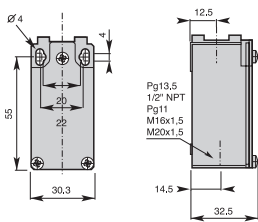

Contact Blocks

Z11 (1NO + 1NC)	AM•T32Z11	AM•T34Z11	AM•T35Z11	AM•T36Z11
X11 (1NO + 1NC)	AM•T32X11	AM•T34X11	AM•T35X11	AM•T36X11
Y11 (1NO + 1NC)	AM•T32Y11	AM•T34Y11	AM•T35Y11	AM•T36Y11
W02 (2NC)	AM•T32W02	AM•T34W02	AM•T35W02	AM•T36W02
W20 (2NO)	AM•T32W20	AM•T34W20	AM•T35W20	AM•T36W20
Z02 (2NC)	AM•T32Z02	AM•T34Z02	AM•T35Z02	AM•T36Z02
X12P (1NO + 2NC)	AM•T32X12P	AM•T34X12P	AM•T35X12P	AM•T36X12P
X21P (2NO + 1NC)	AM•T32X21P	AM•T34X21P	AM•T35X21P	AM•T36X21P
W03P (3NC)	AM•T32W03P	AM•T34W03P	AM•T35W03P	AM•T36W03P

T3• - Plastic roller lever

T32: on metal plunger T34: on plastic plunger

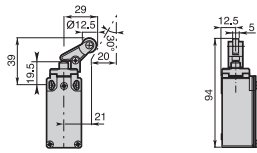

Min. actuating force
Weight

7N (24N ⇄)
175 g

T35 - Plastic roller lever on metal plunger with dust protection cup

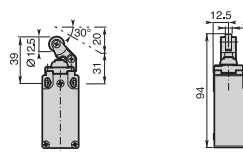

Conformity EN50047
Min. actuating force
Weight

7N (24N ⇄)
170 g

T36 - Plastic roller lever on metal plunger with dust protection cup

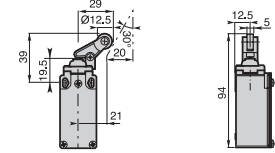

Min. actuating force
Weight

7N (24N ⇄)
175 g

T3• Adjustable plastic roller lever

T38: on metal plunger T39: with dust protection cup

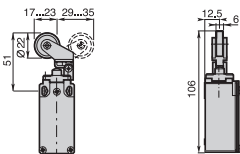

Conformity EN50047
Min. actuating force
Weight

7N (24N ⇄)
175 g

F41 - Ø 18 nylon roller lever

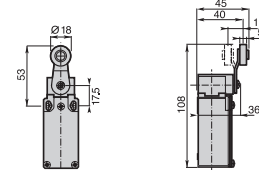

Conformity EN50047
Min. actuating torque
Weight

0,10Nm (0,32Nm ⇄)
235 g

F42 - Ø 50 rubber roller lever

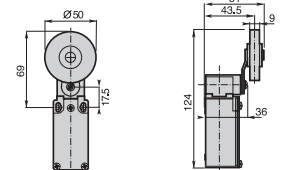

Min. actuating torque
Weight

0,10Nm (0,32Nm ⇄)
255 g

Contact Blocks

Z11 (1NO + 1NC)	AM•T38Z11	AM•T39Z11	AM•F41Z11	AM•F42Z11
X11 (1NO + 1NC)	AM•T38X11	AM•T39X11	AM•F41X11	AM•F42X11
Y11 (1NO + 1NC)	AM•T38Y11	AM•T39Y11	AM•F41Y11	AM•F42Y11
W02 (2NC)	AM•T38W02	AM•T39W02	AM•F41W02	AM•F42W02
W20 (2NO)	AM•T38W20	AM•T39W20	AM•F41W20	AM•F42W20
Z02 (2NC)	AM•T38Z02	AM•T39Z02	AM•F41Z02	AM•F42Z02
X12P (1NO + 2NC)	AM•T38X12P	AM•T39X12P	AM•F41X12P	AM•F42X12P
X21P (2NO + 1NC)	AM•T38X21P	AM•T39X21P	AM•F41X21P	AM•F42X21P
W03P (3NC)	AM•T38W03P	AM•T39W03P	AM•F41W03P	AM•F42W03P

Operation diagrams: page 123 - All dimensions are in mm

Limit Switches **AM_F/AM_T** series

Metal casing IP66 - 30 mm. width

Electrical connection:

- AM1:** one cable inlet for PG 13,5 Cable Gland
- AM2:** one cable inlet by 1/2" NPT Plastic Adapter
- AM3:** one cable inlet for PG11 Cable Gland
- AM4:** one cable inlet for M16 x 1,5 Cable Gland
- AM5:** one cable inlet for M20 x 1,5 Cable Gland
- AM7:** 5 poles M12 metal connector
- AM8:** 8 poles M12 metal connector
- AM10:** 5 poles M12 plastic connector
- AM11:** 8 poles M12 plastic connector

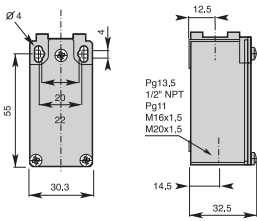

Contact Blocks

- Z11** (1NO + 1NC)
- X11** (1NO + 1NC)
- Y11** (1NO + 1NC)
- W02** (2NC)
- W20** (2NO)
- Z02** (2NC)
- X12P** (1NO + 2NC)
- X21P** (2NO + 1NC)
- W03P** (3NC)

F43 - Ø 18 metal roller lever

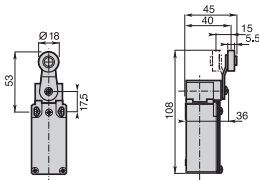

Conformity EN50047

Min. actuating torque 0,10Nm (0,32Nm ⇄)
Weight 240 g

F44 - Ø 19 steel ball bearing roller lever

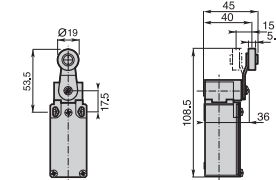

Conformity EN50047

Min. actuating torque 0,10Nm (0,32Nm ⇄)
Weight 240 g

F45 - Ø 18 nylon roller lever

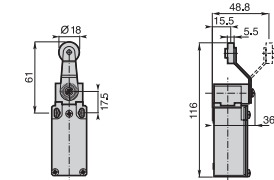

Min. actuating torque 0,10Nm (0,32Nm ⇄)
Weight 250 g

F46 - Ø 18 metal roller lever

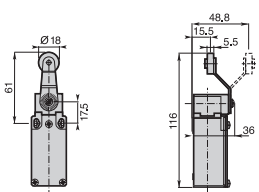

Min. actuating torque 0,10Nm (0,32Nm ⇄)
Weight 255 g

F47 - Ø 19 steel ball bearing roller lever

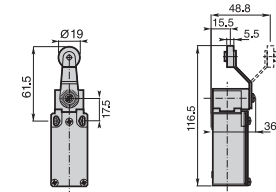

Min. actuating torque 0,10Nm (0,32Nm ⇄)
Weight 255 g

F51- Adjustable lever with Ø 18 nylon roller

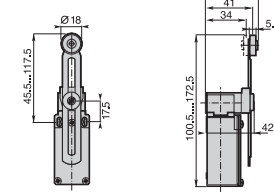

Min. actuating torque 0,10Nm (0,32Nm ⇄)
Weight 250 g

Contact Blocks

- Z11** (1NO + 1NC)
- X11** (1NO + 1NC)
- Y11** (1NO + 1NC)
- W02** (2NC)
- W20** (2NO)
- Z02** (2NC)
- X12P** (1NO + 2NC)
- X21P** (2NO + 1NC)
- W03P** (3NC)

- AM•F46Z11
- AM•F46X11
- AM•F46Y11
- AM•F46W02
- AM•F46W20
- AM•F46Z02
- AM•F46X12P
- AM•F46X21P
- AM•F46W03P

- AM•F47Z11
- AM•F47X11
- AM•F47Y11
- AM•F47W02
- AM•F47W20
- AM•F47Z02
- AM•F47X12P
- AM•F47X21P
- AM•F47W03P

- AM•F51Z11
- AM•F51X11
- AM•F51Y11
- AM•F51W02
- AM•F51W20
- AM•F51Z02
- AM•F51X12P
- AM•F51X21P
- AM•F51W03P

Limit Switches **AM_F/AM_T** series

Metal casing IP66 - 30 mm. width

Electrical connection:

- AM1:** one cable inlet for PG 13,5 Cable Gland
- AM2:** one cable inlet by 1/2" NPT Plastic Adapter
- AM3:** one cable inlet for PG11 Cable Gland
- AM4:** one cable inlet for M16 x 1,5 Cable Gland
- AM5:** one cable inlet for M20 x 1,5 Cable Gland
- AM7:** 5 poles M12 metal connector
- AM8:** 8 poles M12 metal connector
- AM10:** 5 poles M12 plastic connector
- AM11:** 8 poles M12 plastic connector

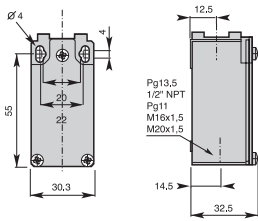

Contact Blocks

Z11 (1NO + 1NC)	AM•F5100Z11	AM•F52Z11	AM•F5200Z11
X11 (1NO + 1NC)	AM•F5100X11	AM•F52X11	AM•F5200X11
Y11 (1NO + 1NC)	AM•F5100Y11	AM•F52Y11	AM•F5200Y11
W02 (2NC)	AM•F5100W02	AM•F52W02	AM•F5200W02
W20 (2NO)	AM•F5100W20	AM•F52W20	AM•F5200W20
Z02 (2NC)	AM•F5100Z02	AM•F52Z02	AM•F5200Z02
X12P (1NO + 2NC)	AM•F5100X12P	AM•F52X12P	AM•F5200X12P
X21P (2NO + 1NC)	AM•F5100X21P	AM•F52X21P	AM•F5200X21P
W03P (3NC)	AM•F5100W03P	AM•F52W03P	AM•F5200W03P

F5100 - Adjustable toothed lever (step 2 mm) with Ø 18 nylon roller

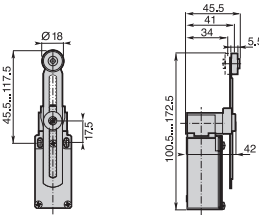

Min. actuating torque **0,10Nm (0,32Nm ⊖)**
Weight **250 g**

F52 - Adjustable lever with Ø 50 rubber roller

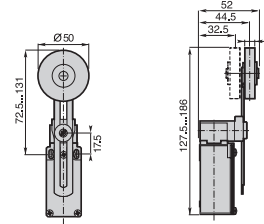

Min. actuating torque **0,10Nm (0,32Nm ⊖)**
Weight **265 g**

F5200 - Adjustable toothed lever (step 2 mm) with Ø 50 rubber roller

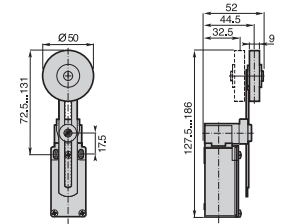

Min. actuating torque **0,10Nm (0,32Nm ⊖)**
Weight **265 g**

F53 - Adjustable lever with Ø 18 metal roller

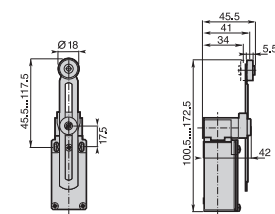
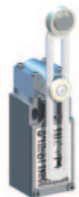

Min. actuating torque **0,10Nm (0,32Nm ⊖)**
Weight **255 g**

F54 - Adjustable lever with Ø 19 steel ball bearing roller

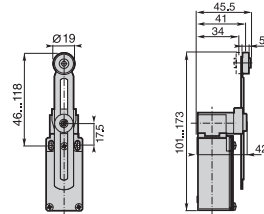
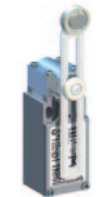

Min. actuating torque **0,10Nm (0,32Nm ⊖)**
Weight **255 g**

F55 - Adjustable lever with adjustable Ø 50 rubber roller

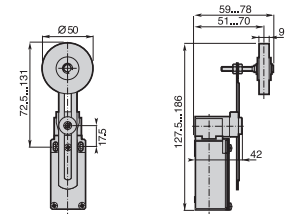

Min. actuating torque **0,10Nm (0,32Nm ⊖)**
Weight **265 g**

Contact Blocks

Z11 (1NO + 1NC)	AM•F53Z11	AM•F54Z11	AM•F55Z11
X11 (1NO + 1NC)	AM•F53X11	AM•F54X11	AM•F55X11
Y11 (1NO + 1NC)	AM•F53Y11	AM•F54Y11	AM•F55Y11
W02 (2NC)	AM•F53W02	AM•F54W02	AM•F55W02
W20 (2NO)	AM•F53W20	AM•F54W20	AM•F55W20
Z02 (2NC)	AM•F53Z02	AM•F54Z02	AM•F55Z02
X12P (1NO + 2NC)	AM•F53X12P	AM•F54X12P	AM•F55X12P
X21P (2NO + 1NC)	AM•F53X21P	AM•F54X21P	AM•F55X21P
W03P (3NC)	AM•F53W03P	AM•F54W03P	AM•F55W03P

Operation diagrams: page 123 - All dimensions are in mm

Limit Switches **AM_F/AM_T** series

Metal casing IP66 - 30 mm. width

Electrical connection:

- AM1:** one cable inlet for PG 13,5 Cable Gland
- AM2:** one cable inlet by 1/2" NPT Plastic Adapter
- AM3:** one cable inlet for PG11 Cable Gland
- AM4:** one cable inlet for M16 x 1,5 Cable Gland
- AM5:** one cable inlet for M20 x 1,5 Cable Gland
- AM7:** 5 poles M12 metal connector
- AM8:** 8 poles M12 metal connector
- AM10:** 5 poles M12 plastic connector
- AM11:** 8 poles M12 plastic connector

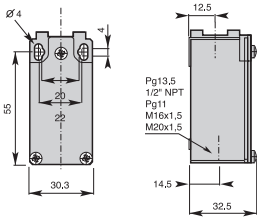

F500 - Adjustable toothed lever with Ø 50 rubber roller

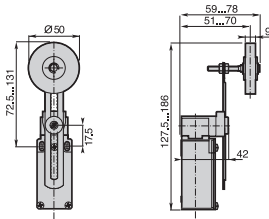

Min. actuating torque **0,10Nm (0,32Nm ⇄)**
Weight **265 g**

F61 - Nylon actuator with stainless steel spring

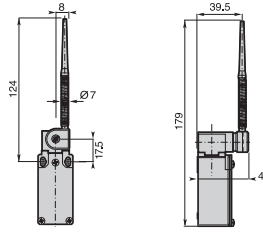

Min. actuating torque **0,10Nm**
Weight **245 g**

F62 - Stainless steel spring actuator

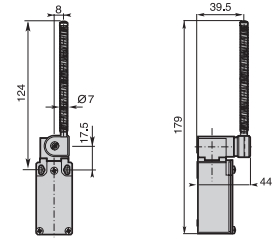

Min. actuating torque **0,10Nm**
Weight **245 g**

Contact Blocks

Z11 (1NO + 1NC)	AM•F5500Z11	AM•F61Z11	AM•F62Z11
X11 (1NO + 1NC)	AM•F5500X11	AM•F61X11	AM•F62X11
Y11 (1NO + 1NC)	AM•F5500Y11	AM•F61Y11	AM•F62Y11
W02 (2NC)	AM•F5500W02	AM•F61W02	AM•F62W02
W20 (2NO)	AM•F5500W20	AM•F61W20	AM•F62W20
Z02 (2NC)	AM•F5500Z02	AM•F61Z02	AM•F62Z02
X12P (1NO + 2NC)	AM•F5500X12P	AM•F61X12P	AM•F62X12P
X21P (2NO + 1NC)	AM•F5500X21P	AM•F61X21P	AM•F62X21P
W03P (3NC)	AM•F5500W03P	AM•F61W03P	AM•F62W03P

F71 - Adjustable Ø 3 rod lever with stainless steel rod

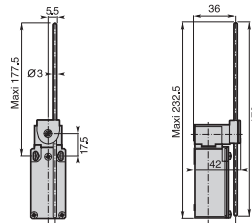

Min. actuating torque **0,10Nm (0,32Nm ⇄)**
Weight **245 g**

T72 - Adjustable Ø 3 rod lever with fiberglass rod

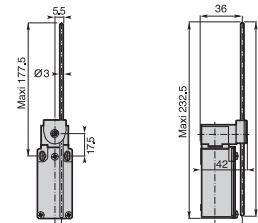

Min. actuating torque **0,10Nm (0,32Nm ⇄)**
Weight **245 g**

T73 - Adjustable Ø 6 rod lever with nylon rod

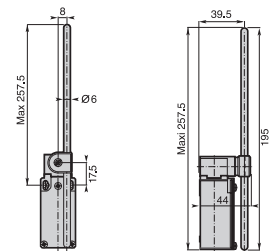

Min. actuating torque **0,10Nm (0,32Nm ⇄)**
Weight **255 g**

Contact Blocks

Z11 (1NO + 1NC)	AM•F71Z11	AM•F72Z11	AM•F73Z11
X11 (1NO + 1NC)	AM•F71X11	AM•F72X11	AM•F73X11
Y11 (1NO + 1NC)	AM•F71Y11	AM•F72Y11	AM•F73Y11
W02 (2NC)	AM•F71W02	AM•F72W02	AM•F73W02
W20 (2NO)	AM•F71W20	AM•F72W20	AM•F73W20
Z02 (2NC)	AM•F71Z02	AM•F72Z02	AM•F73Z02
X12P (1NO + 2NC)	AM•F71X12P	AM•F72X12P	AM•F73X12P
X21P (2NO + 1NC)	AM•F71X21P	AM•F72X21P	AM•F73X21P
W03P (3NC)	AM•F71W03P	AM•F72W03P	AM•F73W03P

Operation diagrams: page 123 - All dimensions are in mm

Limit Switches **AM_F/AM_T** series

Metal casing IP66 - 30 mm. width

Electrical connection:

- AM1:** one cable inlet for PG 13,5 Cable Gland
- AM2:** one cable inlet by 1/2" NPT Plastic Adapter
- AM3:** one cable inlet for PG11 Cable Gland
- AM4:** one cable inlet for M16 x 1,5 Cable Gland
- AM5:** one cable inlet for M20 x 1,5 Cable Gland
- AM7:** 5 poles M12 metal connector
- AM8:** 8 poles M12 metal connector
- AM10:** 5 poles M12 plastic connector
- AM11:** 8 poles M12 plastic connector

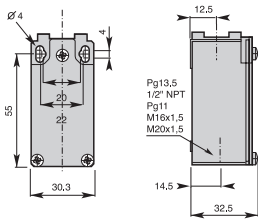

Contact Blocks

Z11 (1NO + 1NC)	AM•F74Z11	AM•F75Z11	AM•T91Z11
X11 (1NO + 1NC)	AM•F74X11	AM•F75X11	AM•T91X11
Y11 (1NO + 1NC)	AM•F74Y11	AM•F75Y11	AM•T91Y11
W02 (2NC)	AM•F74W02	AM•F75W02	AM•T91W02
W20 (2NO)	AM•F74W20	AM•F75W20	AM•T91W20
Z02 (2NC)	AM•F74Z02	AM•F75Z02	AM•T91Z02
X12P (1NO + 2NC)	AM•F74X12P	AM•F75X12P	AM•T91X12P
X21P (2NO + 1NC)	AM•F74X21P	AM•F75X21P	AM•T91X21P
W03P (3NC)	AM•F74W03P	AM•F75W03P	AM•T91W03P

F74 - Adjustable Ø 6 rod lever with fiberglass rod

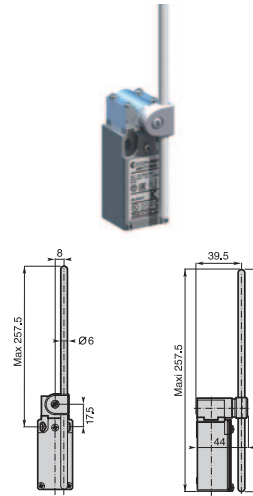

Min. actuating torque **0,10Nm (0,32Nm ⊖)**
Weight **255 g**

T75 - Adjustable 3x3 square steel rod lever

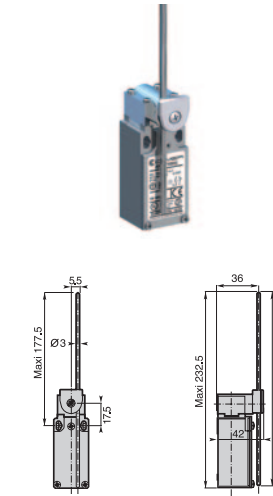

Min. actuating torque **0,10Nm (0,32Nm ⊖)**
Weight **245 g**

T91 - Stainless steel spring multidirectional actuator

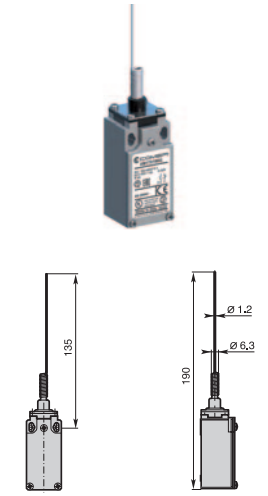

Min. actuating torque **0,12Nm**
Weight **175 g**

T92 - Multidirectional nylon actuator with stainless steel spring

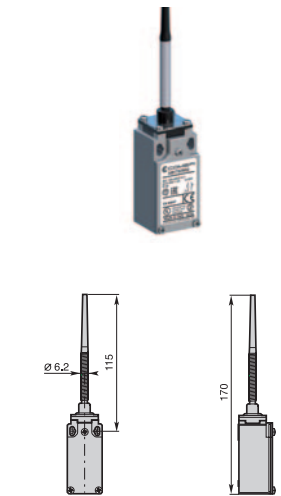

Min. actuating torque **0,12Nm**
Weight **180 g**

T93 - Stainless steel spring multidirectional actuator

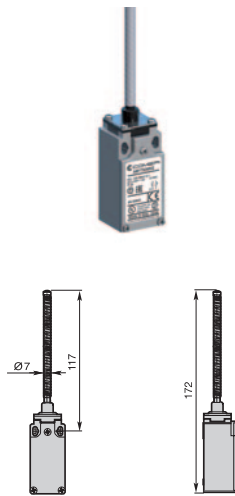

Min. actuating torque **0,12Nm**
Weight **185 g**

T98 - Pull action with ring

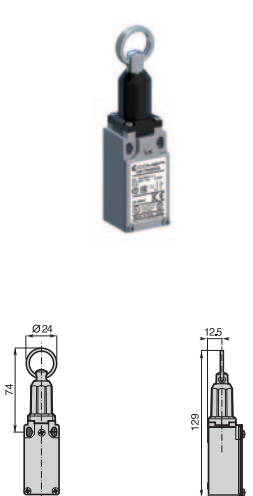

Min. actuating force **30N**
Weight **210 g**

Contact Blocks

Z11 (1NO + 1NC)	AM•T92Z11	AM•T93Z11	AM•T98Z11A
X11 (1NO + 1NC)	AM•T92X11	AM•T93X11	AM•T98X11A
Y11 (1NO + 1NC)	AM•T92Y11	AM•T93Y11	AM•T98Y11A
W02 (2NC)	AM•T92W02	AM•T93W02	AM•T98W02A
W20 (2NO)	AM•T92W20	AM•T93W20	AM•T98W20A
Z02 (2NC)	AM•T92Z02	AM•T93Z02	
X12P (1NO + 2NC)	AM•T92X12P	AM•T93X12P	
X21P (2NO + 1NC)	AM•T92X21P	AM•T93X21P	
W03P (3NC)	AM•T92W03P	AM•T93W03P	

Operation diagrams: page 123 - All dimensions are in mm

Limit Switches **DM series**

Summary

APPROVALS: UL 508 / CSA C22-2 N. 14 / IEC 60947-5-1



CB-SCHEME certification according to IEC 60947-5-1

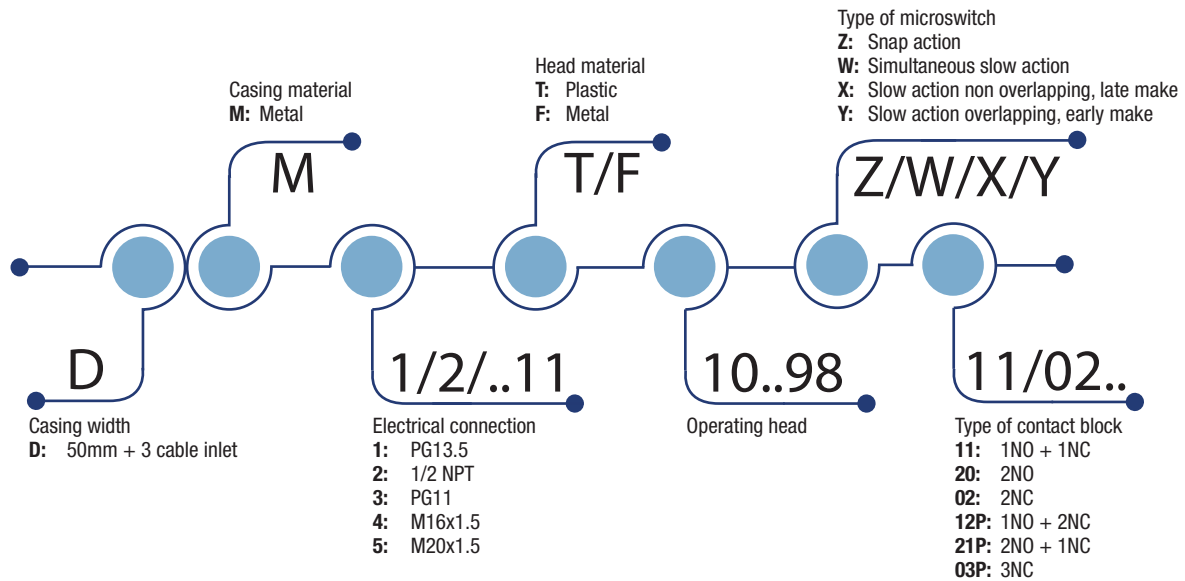

HOW IS IT MADE?

01 A variety of actuators

- Plain plunger
- Roller plunger
- Roller lever, adjustable or not, etc.

02 Wide range of heads

- Assembled using 4 x Ø3 screws

03 Casing:

- 50 mm. width

04 Mounting screws

- 2 or 4 x M4 screws on top part

05 Cover

- 4 screws Ø3 pozidriv 1

06 Contact Block

- Positive opening operation
- Snap action or slow action
- Electrically separated contacts

07 Connecting terminals

- Block of 2 contacts: M3.5 (+, -) pozidriv 2 screw
- Block of 3 contacts: M3 (+, -) screw
- Screw head with captive cable clamp
- Markings conform with IEC 60947-1, IEC 60947-5-1 standards

08 Electrical connection

- 3 x threaded cable inlets suitable for cable gland

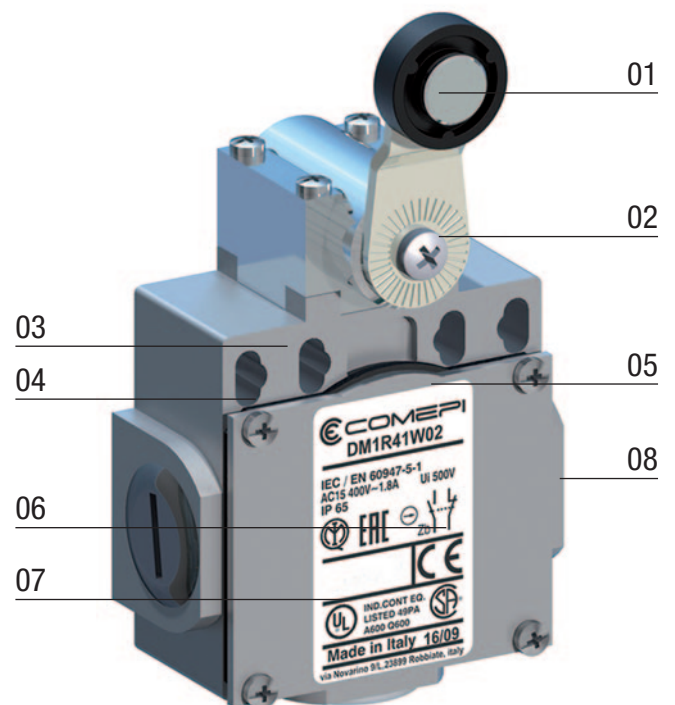

Limit Switches **DM series**

Description

APPLICATIONS

Easy to use, electromechanical limit switches offer specific qualities:

- Visible operation.
- Able to switch strong currents (10 A conventional thermal current).
- Electrically separated contacts.
- Precise operating points (consistency).
- Immune to electromagnetic disturbances.

They are purpose-built detection devices thanks to these characteristics:

- Presence/absence.
- Positioning and travel limit.
- Objects passing/counting.

DESCRIPTION

Limit switches, which are made of zinc alloy (Zamak), offer a degree of protection of IP66.

They comply with the requirements of European Directives (Low Voltage and RoHS) and are conform to European and International Standards.

The CE declaration of these products are available in the download section of website www.comepi.it or by writing to the following email address: tecnico@comepi.it
DDC02 - Limit Switches.

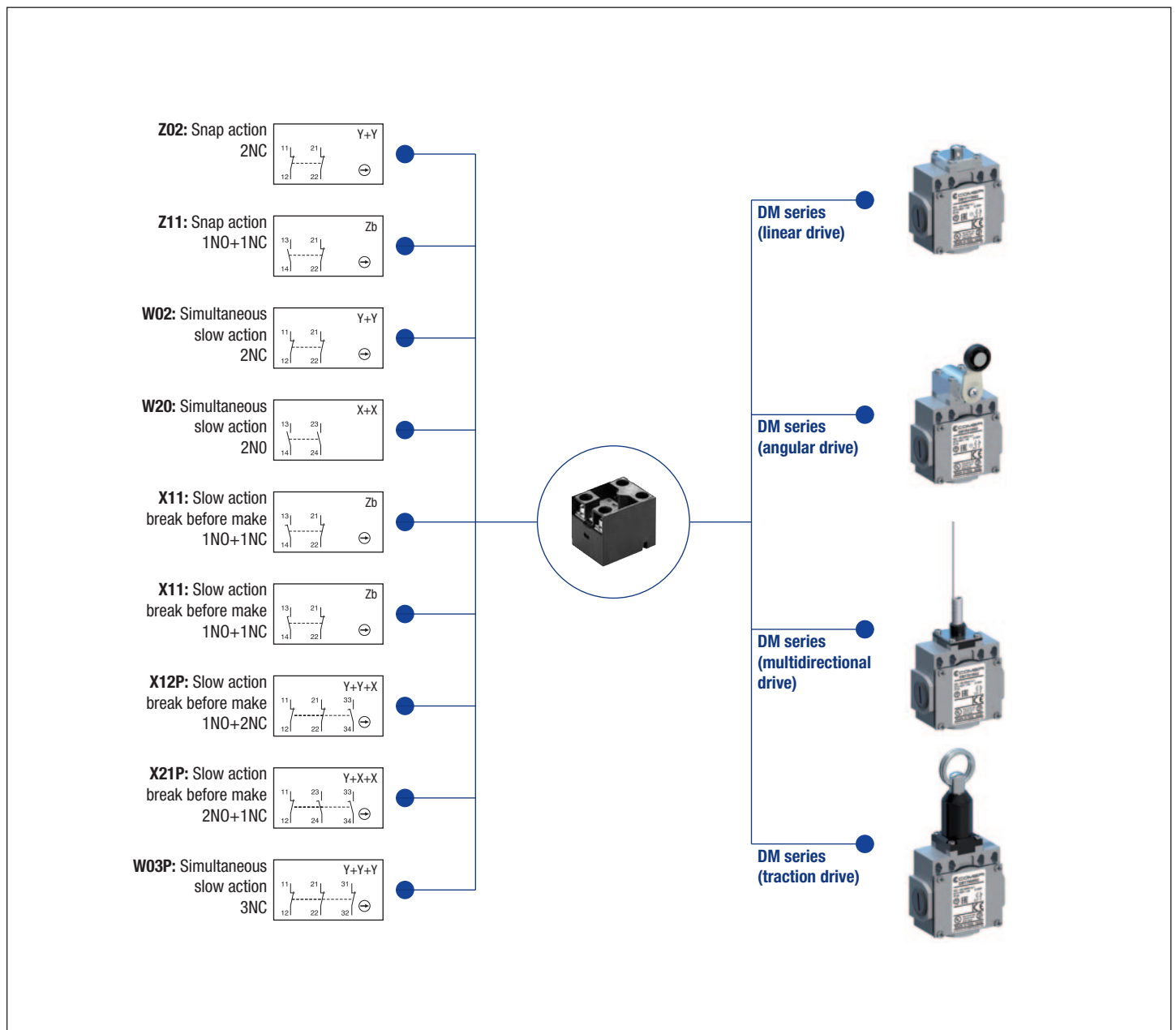

Limit Switches **DM series**

Technical Data

Technical data approved by IMQ

Standards	Devices conform with international IEC 60947-5-1 and European EN 60947-5-1 standards	
Degree of protection	IP 66*	
Rated insulation voltage U_i	500 V (degree of pollution 3) (400V for type Z02, X12P, X21P, W03P)	
Rated impulse withstand voltage U_{imp}	6 kV	
Conventional free air thermal current I_{th}	10 A	
Short-circuit protection - gG (gI) type fuses	10 A	
Rated operational current		
I_e / AC-15	24 V - 50/60 Hz	10 A
	400 V - 50/60 Hz	4 A
I_e / DC-13	24 V - d.c.	6 A
	125 V - d.c.	0.55 A
	250 V - d.c.	0.4 A

* except for F52, F5200, F55, F5500, F73, F74, T92, T93: the degree of protection is IP65

IMPLEMENTATION

Operating head orientation

The head can be rotated each 90°. Recommended tightening torque 0,5 Nm (max 0,8 Nm).

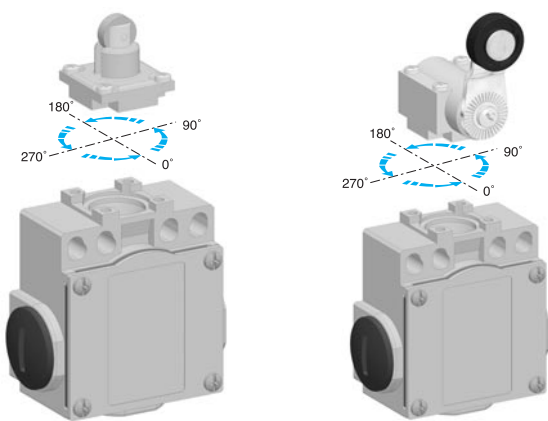

Technical data approved by UL

Standards	Devices conform with UL 508
Contact blocks type Z11, X11, Y11, W02 and Z02	
Utilization categories	A300, Q300
Contact blocks type X12P, X21P and W03P	
Utilization categories	A300, Q300

Use 60/75°C copper (Cu) conductor only. Wire rages 14-18 AWG stranded or solid. The terminal tightening torque of 7 lbs-in / 0.78 Nm. Suitable for conduit connection only with use of adapter sleeve optionally provided or recommended by the manufacturer.

For the complete list of approved products, contact our technical department

Lever adjustment

The lever of the angular actuators can be adjusted every 10° and round turned in order to obtain the maximum flexibility on the working plan. Recommended tightening torque 0,5 Nm (max 0,8 Nm).

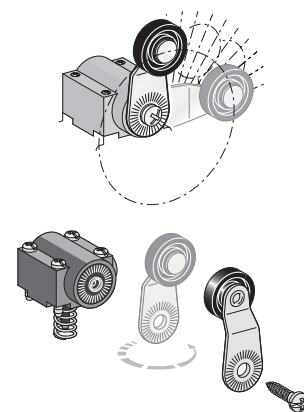

Special Versions

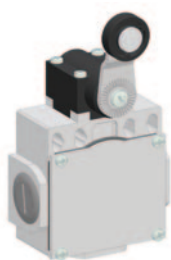

Plastic actuators

The operating heads used in plastic limit switches AP and DP series have the same dimensions of the ones used in the corresponding metal AM and DM series. It is therefore possible to supply "mixed" versions, that is:

- plastic operating head on metal casing
- metal operating head on plastic casing

Manual reset operating head

Limit switches equipped with special operating head with manual reset button.

For more information:



For further informations, please contact our technical department.

Low Temperature

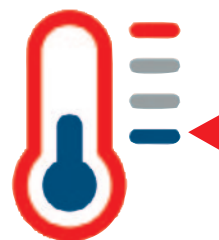

The limit switches for low temperature applications are useful for refrigerated cells or equipments where the air operational temperature is very low. These devices, made in special materials, are able to extend the operational temperature range down to -40°C, maintaining mechanical performances intact.

To order add the digits "40" following the operating head indication in part number.

For example: DM1F11Z11 → DM1F1140Z11

Limit Switches **DM_F/DM_T** series

Metal casing IP66 - 50 mm. width

Electrical connection:

- DM1:** three cable inlets for PG 13,5 Cable Gland
- DM2:** three cable inlets for 1/2" NPT Cable Gland
- DM3:** three cable inlets for PG11 Cable Gland
- DM4:** three cable inlets for M16 x 1,5 Cable Gland
- DM5:** three cable inlets for M20 x 1,5 Cable Gland

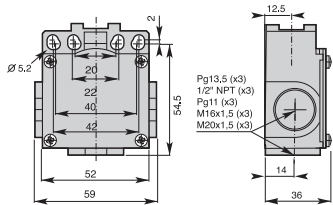

Contact Blocks

Z11 (1NO + 1NC)	DM•F11Z11	DM•F12Z11	DM•T14Z11
X11 (1NO + 1NC)	DM•F11X11	DM•F12X11	DM•T14X11
Y11 (1NO + 1NC)	DM•F11Y11	DM•F12Y11	DM•T14Y11
W02 (2NC)	DM•F11W02	DM•F12W02	DM•T14W02
W20 (2NO)	DM•F11W20	DM•F12W20	DM•T14W20
Z02 (2NC)	DM•F11Z02	DM•F12Z02	DM•T14Z02
X12P (1NO + 2NC)	DM•F11X12P	DM•F12X12P	DM•T14X12P
X21P (2NO + 1NC)	DM•F11X21P	DM•F12X21P	DM•T14X21P
W03P (3NC)	DM•F11W03P	DM•F12W03P	DM•T14W03P

F11 - Plain metal plunger

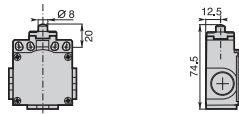

Min. actuating force
Weight

15N (30N ⇄)
270 g

F12 - Metal roller plunger

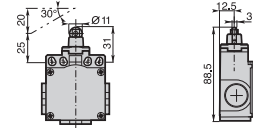

Min. actuating force
Weight

12N (30N ⇄)
280 g

T14 - Metal plunger with dust protection cup

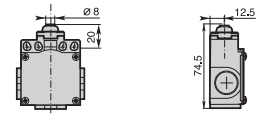

Min. actuating force
Weight

15N (30N ⇄)
255 g

T21 - Plain plunger with M18x1 fixing nuts

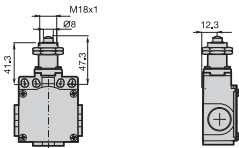

Min. actuating force
Weight

15N (30N ⇄)
265 g

T2101 - Plain plunger with M12x1 fixing nuts

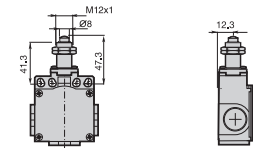

Min. actuating force
Weight

15N (30N ⇄)
265 g

T30 - Plastic roller lever on plastic plunger

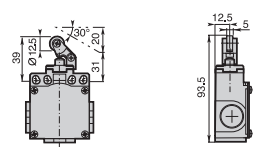

Min. actuating force
Weight

7N (24N ⇄)
260 g

Contact Blocks

Z11 (1NO + 1NC)	DM•T21Z11	DM•T2101Z11	DM•T30Z11
X11 (1NO + 1NC)	DM•T21X11	DM•T2101X11	DM•T30X11
Y11 (1NO + 1NC)	DM•T21Y11	DM•T2101Y11	DM•T30Y11
W02 (2NC)	DM•T21W02	DM•T2101W02	DM•T30W02
W20 (2NO)	DM•T21W20	DM•T2101W20	DM•T30W20
Z02 (2NC)	DM•T21Z02	DM•T2101Z02	DM•T30Z02
X12P (1NO + 2NC)	DM•T21X12P	DM•T2101X12P	DM•T30X12P
X21P (2NO + 1NC)	DM•T21X21P	DM•T2101X21P	DM•T30X21P
W03P (3NC)	DM•T21W03P	DM•T2101W03P	DM•T30W03P

Operation diagrams: page 123 - All dimensions are in mm

Limit Switches DM_F/DM_T series

Metal casing IP66 - 50 mm. width

Electrical connection:

- DM1:** three cable inlets for PG 13,5 Cable Gland
- DM2:** three cable inlets for 1/2" NPT Cable Gland
- DM3:** three cable inlets for PG11 Cable Gland
- DM4:** three cable inlets for M16 x 1,5 Cable Gland
- DM5:** three cable inlets for M20 x 1,5 Cable Gland

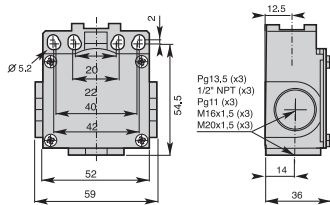

Contact Blocks

- Z11** (1NO + 1NC)
- X11** (1NO + 1NC)
- Y11** (1NO + 1NC)
- W02** (2NC)
- W20** (2NO)
- Z02** (2NC)
- X12P** (1NO + 2NC)
- X21P** (2NO + 1NC)
- W03P** (3NC)

T31 - Plastic roller lever on metal plunger

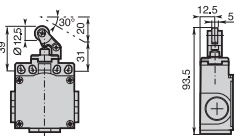

Min. actuating force
Weight **7N (24N ⇄)**
260 g

T35 - Plastic roller lever on metal plunger with dust protection cup

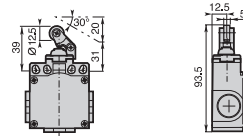

Min. actuating force
Weight **7N (24N ⇄)**
260 g

T38 - Adjustable plastic roller lever on metal plunger

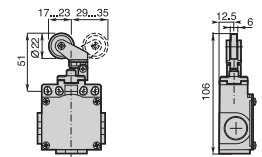

Min. actuating force
Weight **7N (24N ⇄)**
265 g

T39 - Adjustable plastic roller lever on metal plunger with dust protection cup

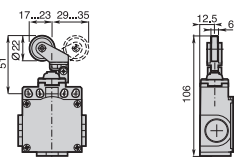

Min. actuating force
Weight **7N (24N ⇄)**
265 g

F41 - Ø 18 nylon roller

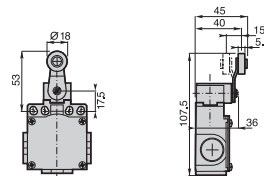

Min. actuating torque
Weight **0,10Nm (0,32Nm ⇄)**
320 g

F42 - Ø 50 rubber roller lever

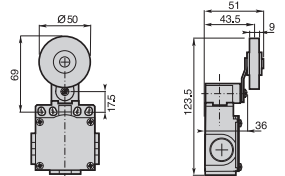

Min. actuating torque
Weight **0,10Nm (0,32Nm ⇄)**
345 g

Contact Blocks

- Z11** (1NO + 1NC)
- X11** (1NO + 1NC)
- Y11** (1NO + 1NC)
- W02** (2NC)
- W20** (2NO)
- Z02** (2NC)
- X12P** (1NO + 2NC)
- X21P** (2NO + 1NC)
- W03P** (3NC)

- DM•T31Z11**
- DM•T31X11**
- DM•T31Y11**
- DM•T31W02**
- DM•T31W20**
- DM•T31Z02**
- DM•T31X12P**
- DM•T31X21P**
- DM•T31W03P**

- DM•T35Z11**
- DM•T35X11**
- DM•T35Y11**
- DM•T35W02**
- DM•T35W20**
- DM•T35Z02**
- DM•T35X12P**
- DM•T35X21P**
- DM•T35W03P**

- DM•T38Z11**
- DM•T38X11**
- DM•T38Y11**
- DM•T38W02**
- DM•T38W20**
- DM•T38Z02**
- DM•T38X12P**
- DM•T38X21P**
- DM•T38W03P**

Operation diagrams: page 123 - All dimensions are in mm

Limit Switches **DM_F/DM_T** series

Metal casing IP66 - 50 mm. width

Electrical connection:

- DM1:** three cable inlets for PG 13,5 Cable Gland
- DM2:** three cable inlets for 1/2" NPT Cable Gland
- DM3:** three cable inlets for PG11 Cable Gland
- DM4:** three cable inlets for M16 x 1,5 Cable Gland
- DM5:** three cable inlets for M20 x 1,5 Cable Gland

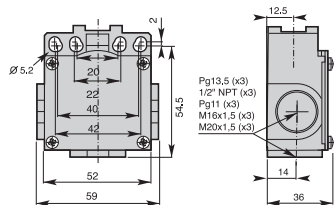

Contact Blocks

Z11 (1NO + 1NC)	DM•F43Z11	DM•F44Z11	DM•F45Z11
X11 (1NO + 1NC)	DM•F43X11	DM•F44X11	DM•F45X11
Y11 (1NO + 1NC)	DM•F43Y11	DM•F44Y11	DM•F45Y11
W02 (2NC)	DM•F43W02	DM•F44W02	DM•F45W02
W20 (2NO)	DM•F43W20	DM•F44W20	DM•F45W20
Z02 (2NC)	DM•F43Z02	DM•F44Z02	DM•F45Z02
X12P (1NO + 2NC)	DM•F43X12P	DM•F44X12P	DM•F45X12P
X21P (2NO + 1NC)	DM•F43X21P	DM•F44X21P	DM•F45X21P
W03P (3NC)	DM•F43W03P	DM•F44W03P	DM•F45W03P

F43 - Ø 18 metal roller lever

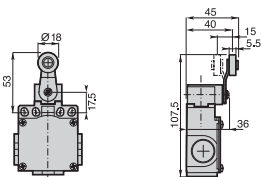

Min. actuating torque 0,10Nm (0,32Nm ⊖)
Weight 325 g

F44 - Ø 19 steel ball bearing roller lever

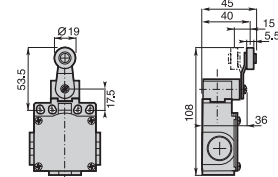

Min. actuating torque 0,10Nm (0,32Nm ⊖)
Weight 325 g

F45 - Ø 18 nylon roller lever

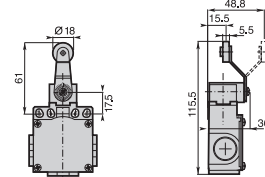
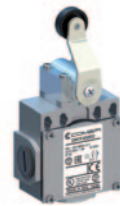

Min. actuating torque 0,10Nm (0,32Nm ⊖)
Weight 335 g

F46 - Ø 18 metal roller lever

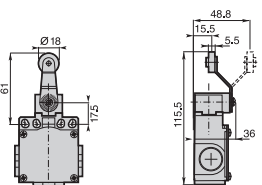

Min. actuating torque 0,10Nm (0,32Nm ⊖)
Weight 340 g

F47 - Ø 19 steel ball bearing roller lever

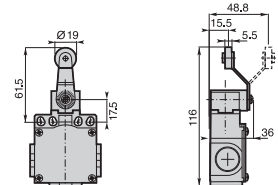

Min. actuating torque 0,10Nm (0,32Nm ⊖)
Weight 340 g

F51 - Adjustable lever with Ø 18 nylon roller

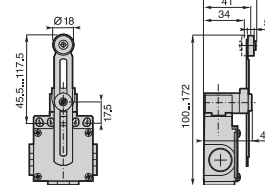

Min. actuating torque 0,10Nm (0,32Nm ⊖)
Weight 335 g

Contact Blocks

Z11 (1NO + 1NC)	DM•F46Z11	DM•F47Z11	DM•F51Z11
X11 (1NO + 1NC)	DM•F46X11	DM•F47X11	DM•F51X11
Y11 (1NO + 1NC)	DM•F46Y11	DM•F47Y11	DM•F51Y11
W02 (2NC)	DM•F46W02	DM•F47W02	DM•F51W02
W20 (2NO)	DM•F46W20	DM•F47W20	DM•F51W20
Z02 (2NC)	DM•F46Z02	DM•F47Z02	DM•F51Z02
X12P (1NO + 2NC)	DM•F46X12P	DM•F47X12P	DM•F51X12P
X21P (2NO + 1NC)	DM•F46X21P	DM•F47X21P	DM•F51X21P
W03P (3NC)	DM•F46W03P	DM•F47W03P	DM•F51W03P

Operation diagrams: page 123 - All dimensions are in mm

Limit Switches DM_F/DM_T series

Metal casing IP66 - 50 mm. width

Electrical connection:

- DM1:** three cable inlets for PG 13,5 Cable Gland
- DM2:** three cable inlets for 1/2" NPT Cable Gland
- DM3:** three cable inlets for PG11 Cable Gland
- DM4:** three cable inlets for M16 x 1,5 Cable Gland
- DM5:** three cable inlets for M20 x 1,5 Cable Gland

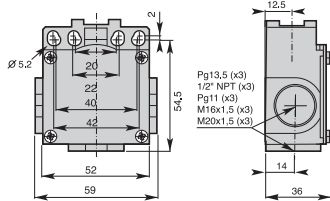

Contact Blocks

- Z11 (1NO + 1NC)
- X11 (1NO + 1NC)
- Y11 (1NO + 1NC)
- W02 (2NC)
- W20 (2NO)
- Z02 (2NC)
- X12P (1NO + 2NC)
- X21P (2NO + 1NC)
- W03P (3NC)

F5100 - Adjustable toothed lever (step 2 mm) with Ø 18 nylon roller

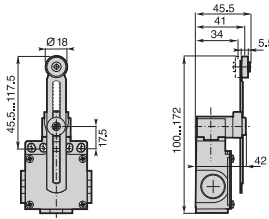

Min. actuating torque **0,10Nm (0,32Nm ⊖)**
Weight **335 g**

F52 - Adjustable lever with Ø 50 rubber roller

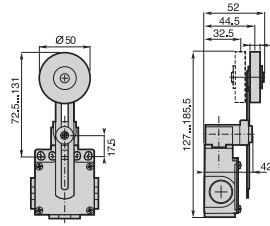

Min. actuating torque **0,10Nm (0,32Nm ⊖)**
Weight **355 g**

F5200 - Adjustable toothed lever (step 2 mm) with Ø 50 rubber roller

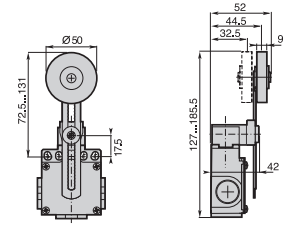
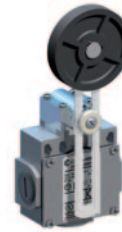

Min. actuating torque **0,10Nm (0,32Nm ⊖)**
Weight **355 g**

F53 - Adjustable lever with Ø 18 metal roller

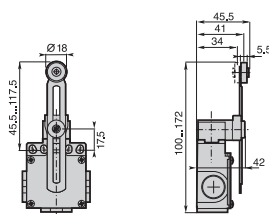

Min. actuating torque **0,10Nm (0,32Nm ⊖)**
Weight **340 g**

F54 - Adjustable lever with Ø 19 steel ball bearing roller

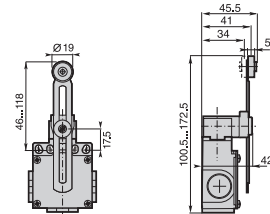

Min. actuating torque **0,10Nm (0,32Nm ⊖)**
Weight **340 g**

F55 - Adjustable lever with adjustable Ø 50 rubber roller

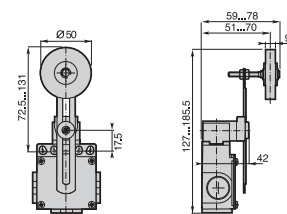
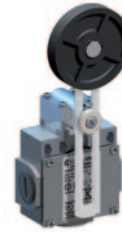

Min. actuating torque **0,10Nm (0,32Nm ⊖)**
Weight **355 g**

Contact Blocks

- Z11 (1NO + 1NC)
- X11 (1NO + 1NC)
- Y11 (1NO + 1NC)
- W02 (2NC)
- W20 (2NO)
- Z02 (2NC)
- X12P (1NO + 2NC)
- X21P (2NO + 1NC)
- W03P (3NC)

- DM•F53Z11
- DM•F53X11
- DM•F53Y11
- DM•F53W02
- DM•F53W20
- DM•F53Z02
- DM•F53X12P
- DM•F53X21P
- DM•F53W03P

- DM•F54Z11
- DM•F54X11
- DM•F54Y11
- DM•F54W02
- DM•F54W20
- DM•F54Z02
- DM•F54X12P
- DM•F54X21P
- DM•F54W03P

- DM•F55Z11
- DM•F55X11
- DM•F55Y11
- DM•F55W02
- DM•F55W20
- DM•F55Z02
- DM•F55X12P
- DM•F55X21P
- DM•F55W03P

Operation diagrams: page 123 - All dimensions are in mm

Limit Switches **DM_F/DM_T** series

Metal casing IP66 - 50 mm. width

Electrical connection:

- DM1:** three cable inlets for PG 13,5 Cable Gland
- DM2:** three cable inlets for 1/2" NPT Cable Gland
- DM3:** three cable inlets for PG11 Cable Gland
- DM4:** three cable inlets for M16 x 1,5 Cable Gland
- DM5:** three cable inlets for M20 x 1,5 Cable Gland

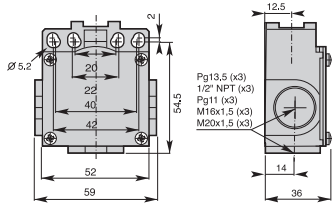

Contact Blocks

- Z11** (1NO + 1NC)
- X11** (1NO + 1NC)
- Y11** (1NO + 1NC)
- W02** (2NC)
- W20** (2NO)
- Z02** (2NC)
- X12P** (1NO + 2NC)
- X21P** (2NO + 1NC)
- W03P** (3NC)

F500 - Adjustable toothed lever with Ø 50 rubber roller

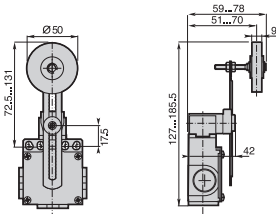
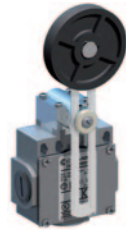

Min. actuating torque **0,10Nm (0,32Nm ⇄)**
Weight **355 g**

F61 - Nylon actuator with stainless steel spring

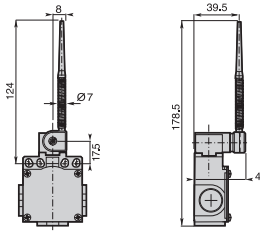

Min. actuating torque **0,10Nm**
Weight **305 g**

F62 - Stainless steel spring actuator

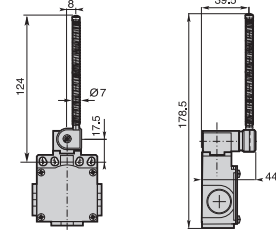

Min. actuating torque **0,10Nm**
Weight **305 g**

F71 - Adjustable Ø 3 rod lever with stainless steel rod

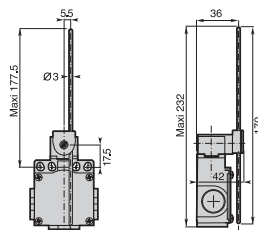

Min. actuating torque **0,10Nm (0,32Nm ⇄)**
Weight **380 g**

F72 - Adjustable Ø 3 rod lever with fiberglass rod

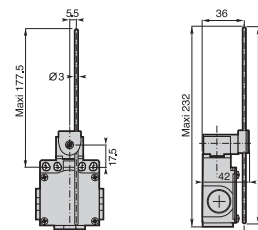

Min. actuating torque **0,10Nm (0,32Nm ⇄)**
Weight **380 g**

F73 - Adjustable Ø 6 rod lever with nylon rod

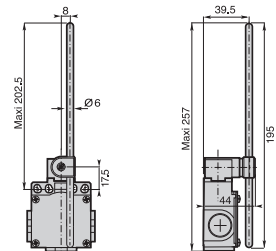

Min. actuating torque **0,10Nm (0,32Nm ⇄)**
Weight **390 g**

Contact Blocks

- Z11** (1NO + 1NC)
- X11** (1NO + 1NC)
- Y11** (1NO + 1NC)
- W02** (2NC)
- W20** (2NO)
- Z02** (2NC)
- X12P** (1NO + 2NC)
- X21P** (2NO + 1NC)
- W03P** (3NC)

- DM•F71Z11
- DM•F71X11
- DM•F71Y11
- DM•F71W02
- DM•F71W20
- DM•F71Z02
- DM•F71X12P
- DM•F71X21P
- DM•F71W03P

- DM•F72Z11
- DM•F72X11
- DM•F72Y11
- DM•F72W02
- DM•F72W20
- DM•F72Z02
- DM•F72X12P
- DM•F72X21P
- DM•F72W03P

- DM•F73Z11
- DM•F73X11
- DM•F73Y11
- DM•F73W02
- DM•F73W20
- DM•F73Z02
- DM•F73X12P
- DM•F73X21P
- DM•F73W03P

Limit Switches DM_F/DM_T series

Metal casing IP66 - 50 mm. width

Electrical connection:

- DM1:** three cable inlets for PG 13,5 Cable Gland
- DM2:** three cable inlets for 1/2" NPT Cable Gland
- DM3:** three cable inlets for PG11 Cable Gland
- DM4:** three cable inlets for M16 x 1,5 Cable Gland
- DM5:** three cable inlets for M20 x 1,5 Cable Gland

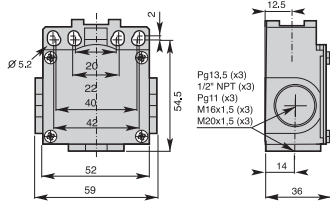

Contact Blocks

- Z11** (1NO + 1NC)
- X11** (1NO + 1NC)
- Y11** (1NO + 1NC)
- W02** (2NC)
- W20** (2NO)
- Z02** (2NC)
- X12P** (1NO + 2NC)
- X21P** (2NO + 1NC)
- W03P** (3NC)

F74 - Adjustable Ø 6 rod lever with fiberglass rod

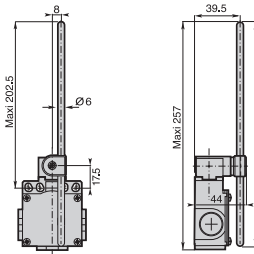

Min. actuating torque **0,10Nm (0,32Nm ⊖)**
Weight **390 g**

T75 - Adjustable 3x3 square steel rod lever

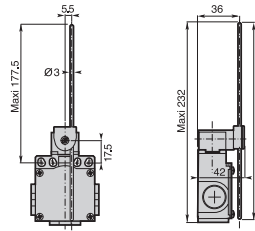

Min. actuating torque **0,10Nm (0,32Nm ⊖)**
Weight **380 g**

T91 - Stainless steel spring multidirectional actuator

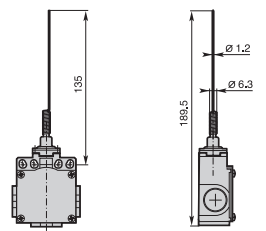

Min. actuating torque **0,12Nm**
Weight **265 g**

T92 - Multidirectional nylon actuator with stainless steel spring

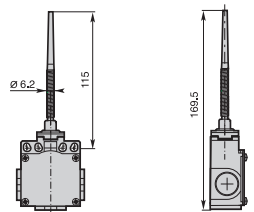

Min. actuating torque **0,12Nm**
Weight **270 g**

T93 - Stainless steel spring multidirectional actuator

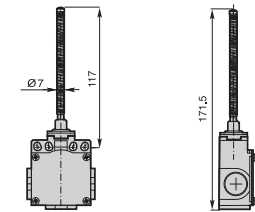

Min. actuating torque **0,12Nm**
Weight **275 g**

T98 - Pull action with ring

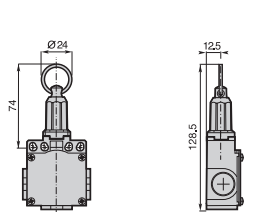

Min. actuating force **30N**
Weight **300 g**

Contact Blocks

- Z11** (1NO + 1NC)
- X11** (1NO + 1NC)
- Y11** (1NO + 1NC)
- W02** (2NC)
- W20** (2NO)
- Z02** (2NC)
- X12P** (1NO + 2NC)
- X21P** (2NO + 1NC)
- W03P** (3NC)

- DM•F74Z11**
- DM•F74X11**
- DM•F74Y11**
- DM•F74W02**
- DM•F74W20**
- DM•F74Z02**
- DM•F74X12P**
- DM•F74X21P**
- DM•F74W03P**

- DM•F75Z11**
- DM•F75X11**
- DM•F75Y11**
- DM•F75W02**
- DM•F75W20**
- DM•F75Z02**
- DM•F75X12P**
- DM•F75X21P**
- DM•F75W03P**

- DM•T91Z11**
- DM•T91X11**
- DM•T91Y11**
- DM•T91W02**
- DM•T91W20**
- DM•T91Z02**
- DM•T91X12P**
- DM•T91X21P**
- DM•T91W03P**

Operation diagrams: page 123 - All dimensions are in mm

Limit Switches **BP series**

Summary

APPROVALS: UL 508 / CSA C22-2 N. 14 / IEC 60947-5-1



CB-SCHEME certification according to IEC 60947-5-1

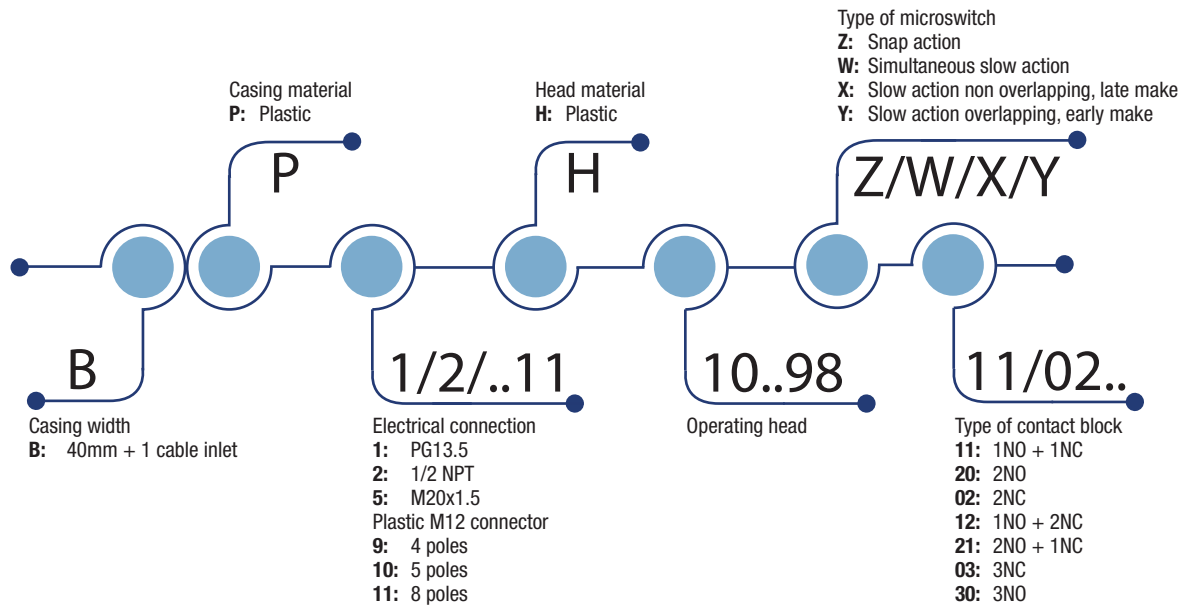

HOW IS IT MADE?

01 A variety of actuators

- Plain plunger
- Roller plunger
- Roller lever, adjustable or not, etc.

02 Wide range of heads

- Assembled using 4 x Ø3 screws

03 Casing:

- 40 mm. with dimensions acc. to EN 50041

04 Mounting screws

- 2 or 4 x M5 screws on top part

05 Cover

- None

06 Contact Block

- Positive opening operation
- Snap action or slow action
- Electrically separated contacts

07 Connecting terminals

- Block of 2 contacts: M3.5 (+, -) pozidriv 2 screw
- Block of 3 contacts: M3 (+, -) screw
- Screw head with captive cable clamp
- Markings conform with IEC 60947-1, IEC 60947-5-1 standards

08 Electrical connection

- 1 x threaded cable inlet suitable for cable gland or M12 connector

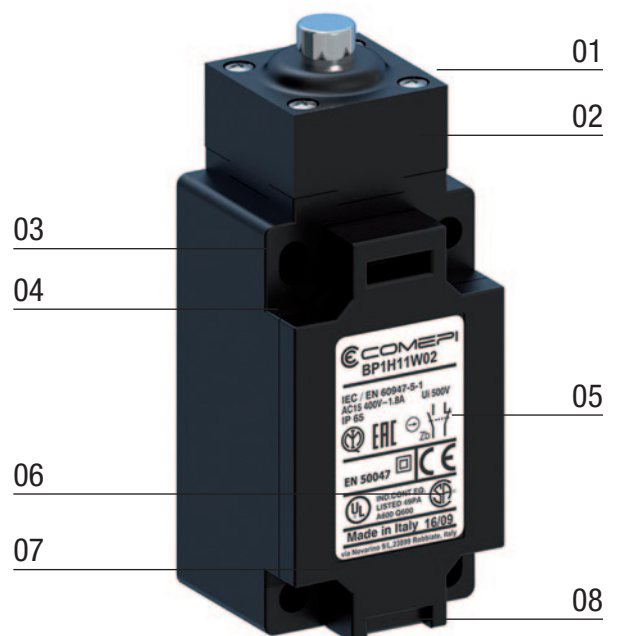

Limit Switches **BP series**

Description

APPLICATIONS

Easy to use, electromechanical limit switches offer specific qualities:

- Visible operation.
- Able to switch strong currents (10 A conventional thermal current).
- Electrically separated contacts.
- Precise operating points (consistency).
- Immune to electromagnetic disturbances.

They are purpose-built detection devices thanks to these characteristics:

- Presence/absence.
- Positioning and travel limit.
- Objects passing/counting.

DESCRIPTION

Limit switches, which are made of reinforced UL-VO thermoplastic fiber-glass, offer double insulation \square and a degree of protection of IP65.

They comply with the requirements of European Directives (Low Voltage and RoHS) and are conform to European and International Standards.

The CE declaration of these products are available in the download section of website www.comepi.it or by writing to the following email address: tecnico@comepi.it
DDC02 - Limit Switches.

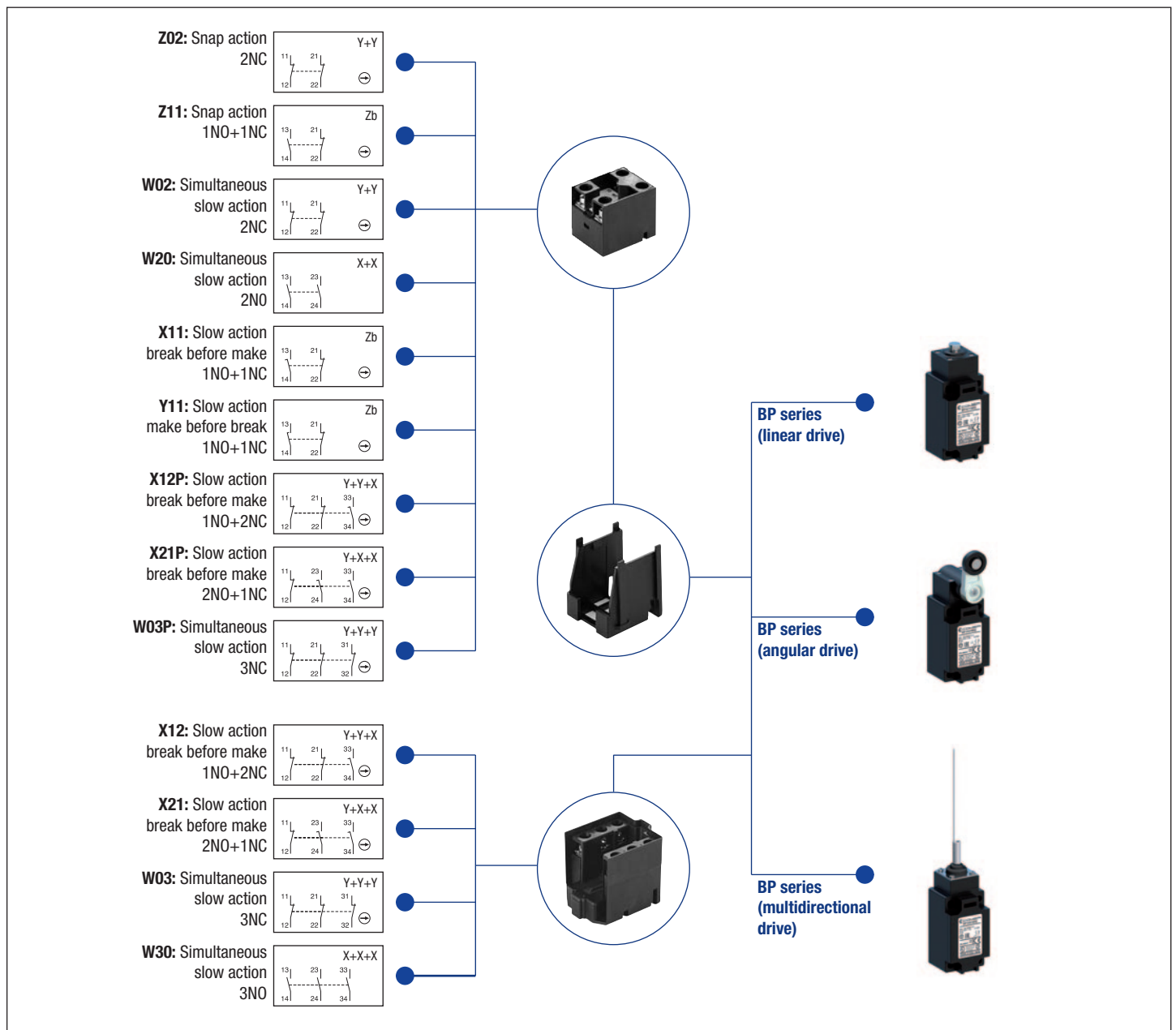

Limit Switches **BP series**

Technical Data

	BP Series	
Standards	IEC 60947-5-1 EN 60947-5-1	
Certifications - Approvals	UL - CSA - IMQ - EAC - CCC - UKCA	
Air temperature near the device		
– during operation	°C	– 25 ... + 70
– for storage	°C	– 30 ... + 80
Mounting positions	All positions are authorised	
Protection against electrical shocks (acc. to IEC 61140)	Class II	
Degree of protection (according to IEC 60529 and EN 60529)	IP65 - IP67	

Electrical Data

Rated insulation voltage U_i - according to IEC 60947-1 and EN 60947-1 - according to UL 508 and CSA C22-2 n° 14	500 V (degree of pollution 3) (400 V for contacts type Z02) A 600, Q 600	
Rated impulse withstand voltage U_{imp} (according to IEC 60947-1 and EN 60947-1)	kV	6
Conventional free air thermal current I_{th} (according to IEC 60947-5-1) $\theta < 40$ °C	A	10
Short-circuit protection $U_e < 500$ V a.c. - gG (gl) type fuses	A	10
Rated operational current I_e / AC-15 (according to IEC 60947-5-1)	24 V - 50/60 Hz A 120 V - 50/60 Hz A 400 V - 50/60 Hz A	10 6 4 (1.8A for contacts type X12, X21, W03, W30)
I_e / DC-13 (according to IEC 60947-5-1)	24 V - d.c. A 125 V - d.c. A 250 V - d.c. A	6 (2.8A for contacts type X12, X21, W03, W30) 0.55 0.4 (0.27A for contacts type X12, X21, W03, W30)
Switching frequency	Cycles/h	3600
Load factor		0.5
Resistance between contacts	m Ω	25
Connecting terminals	M3.5 (+, -) pozidriv 2 screw with cable clamp (M3 for 3 poles contacts type)	
Terminal for protective conductor	-	
Connecting capacity	1 or 2 x mm ²	0.34 ... 2.5 (0.34... 1.5 for 3 poles contacts type)
Terminal marking	According to IEC 60947-5-1	
Recommended tightening torque	Plastic	
Cover	0,5Nm, max 0,8	
Head	0,5Nm, max 0,8	
Microswitch	0,8Nm, max 0,9	
Mechanical durability	30 millions of operations 25 millions of operations 10 millions of operations	H11...13; H31...33 H41...44; H51...54; H61...75 H14; H19; H35...37; H91...93
Electrical durability (according to IEC 60947-5-1)	Utilization categories AC-15 and DC-13 (Load factor of 0.5 according to curves below)	

AC-15 - Snap action

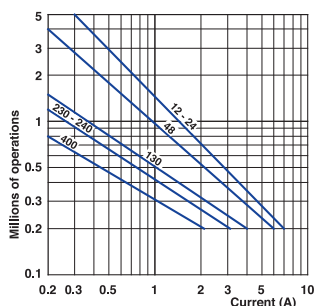

AC-15 - Slow action

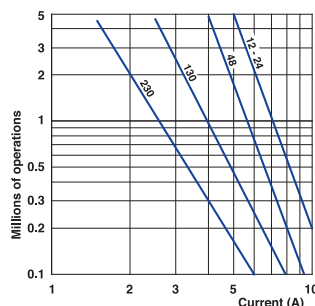

DC-13	Snap action	Slow action
	Power breaking for a durability of 5 million operating cycles	
Voltage 24 V	9.5 W	12 W
Voltage 48 V	6.8 W	9 W
Voltage 110 V	3.6 W	6 W

Limit Switches **BP series**

Technical Data

Technical data approved by IMQ

Standards	Devices conform with international IEC 60947-5-1 and European EN 60947-5-1 standards	
Degree of protection	IP 65	
Rated insulation voltage U_i	500 V (degree of pollution 3) (400V for type Z02)	
Rated impulse withstand voltage U_{imp}	6 kV	
Conventional free air thermal current I_{th}	10 A	
Short-circuit protection - gG (gl) type fuses	10 A	
Rated operational current		
I_e / AC-15	24 V - 50/60 Hz	10 A
	400 V - 50/60 Hz	4 A (1.8A for contacts type X12, X21, W03, W30)
I_e / DC-13	24 V - d.c.	6 A (2.8A for contacts type X12, X21, W03, W30)
	125 V - d.c.	0.55 A
	250 V - d.c.	0.4 A (0.27A for contacts type X12, X21, W03, W30)

Technical data approved by UL

Standards	Devices conform with UL 508
Contact blocks type Z11, X11, Y11, W02 and Z02	
Utilization categories	A600, Q600
Contact blocks type X12, X21, W03 and W30	
Utilization categories	A600, Q600

Use 60/75°C copper (Cu) conductor only. Wire rages 14-18 AWG stranded or solid. The terminal tightening torque of 7 lbs-in / 0.78 Nm. Suitable for conduit connection only with use of adapter sleeve optionally provided or recommended by the manufacturer.

For the complete list of approved products, contact our technical department

IMPLEMENTATION

Operating head orientation

The head can be rotated each 90°. Recommended tightening torque 0,5 Nm (max 0,8 Nm).

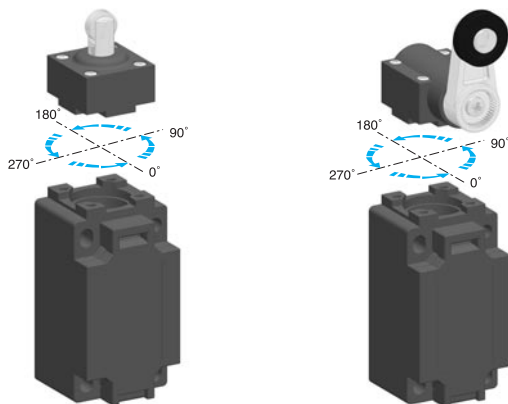

Lever adjustment

The lever of the angular actuators can be adjusted every 9° and round turned in order to obtain the maximum flexibility on the working plan. Recommended tightening torque 0,5 Nm (max 0,8 Nm).

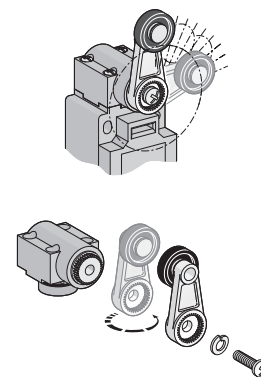

Operating mode selection

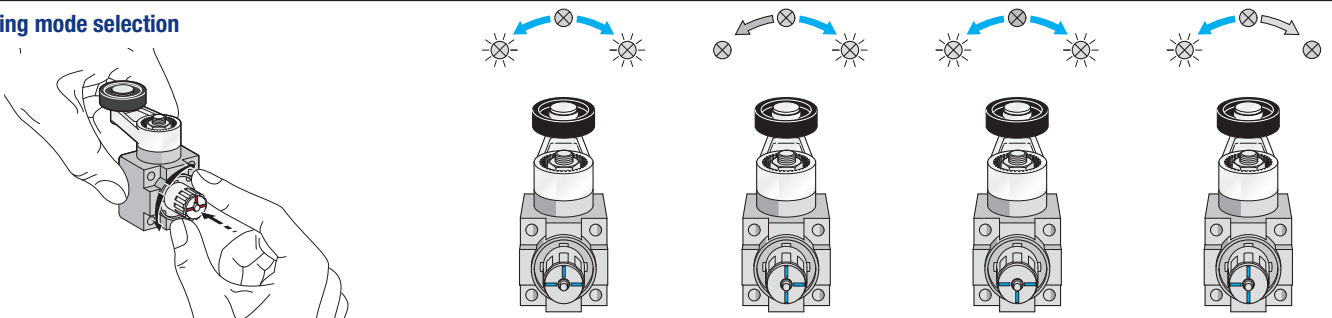

Special Versions

M12 CONNECTOR

Prewired versions with 4, 5 or 8 poles M12 male connectors. Available with plastic threaded body. See page 117 for more details.

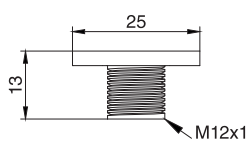

Low Temperature

The limit switches for low temperature applications are useful for refrigerated cells or equipments where the air operational temperature is very low.

These devices, made in special materials, are able to extend the operational temperature range down to -40°C, maintaining mechanical performances intact. To order add the digits "40" following the operating head indication in part number.

For example: BP1H11Z11 ▶ BP1H1140Z11

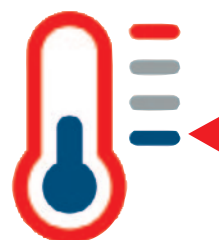

Limit Switches **BP series**

Double Insulation - Plastic Casing IP65 - 40 mm. width

Electrical connection:

- BP1:** one cable inlet for PG 13,5 Cable Gland
- BP2:** one cable inlet for 1/2" NPT Cable Gland
- BP5:** one cable inlet for M20 x 1,5 Cable Gland
- BP9:** 4 poles M12 plastic connector
- BP10:** 5 poles M12 plastic connector
- BP11:** 8 poles M12 plastic connector

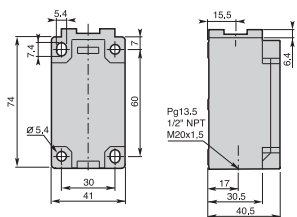

Contact Blocks

Z11 (1NO + 1NC)	BP•H11Z11	BP•H12Z11	BP•H13Z11
X11 (1NO + 1NC)	BP•H11X11	BP•H12X11	BP•H13X11
Y11 (1NO + 1NC)	BP•H11Y11	BP•H12Y11	BP•H13Y11
W02 (2NC)	BP•H11W02	BP•H12W02	BP•H13W02
W20 (2NO)	BP•H11W20	BP•H12W20	BP•H13W20
Z02 (2NC)	BP•H11Z02	BP•H12Z02	BP•H13Z02
X12 (1NO + 2NC)	BP•H11X12	BP•H12X12	BP•H13X12
X21 (2NO + 1NC)	BP•H11X21	BP•H12X21	BP•H13X21
W03 (3NC)	BP•H11W03	BP•H12W03	BP•H13W03
W30 (3NO)	BP•H11W30	BP•H12W30	BP•H13W30

H11 - Plain steel plunger

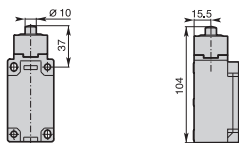

Conformity EN50041
Min. actuating force
Weight

14N (40N ⇄)
145 g

H12 - Steel ball plunger

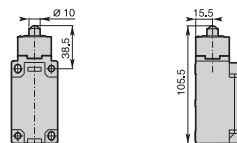

Conformity EN50041
Min. actuating force
Weight

14N (40N ⇄)
145 g

H13 - Steel roller plunger

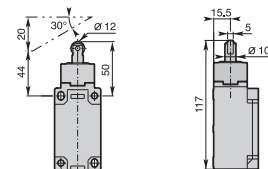

Conformity EN50041
Min. actuating force
Weight

14N (40N ⇄)
150 g

H14 - Plain steel plunger with dust protection cup

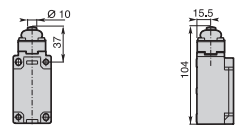

Conformity EN50041
Min. actuating force
Weight

14N (40N ⇄)
145 g

H19 - Steel roller plunger with dust protection cup

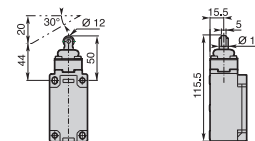

Conformity EN50041
Min. actuating force
Weight

14N (40N ⇄)
150 g

H3 - One way roller

H31: Ø22 nylon roller H32: Ø22 stainless steel roller

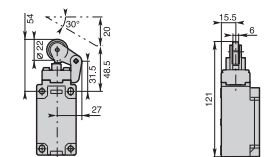

Min. actuating force
Weight

8N (30N ⇄)
185 g

Contact Blocks

Z11 (1NO + 1NC)	BP•H14Z11	BP•H19Z11	BP•H31Z11	BP•H32Z11
X11 (1NO + 1NC)	BP•H14X11	BP•H19X11	BP•H31X11	BP•H32X11
Y11 (1NO + 1NC)	BP•H14Y11	BP•H19Y11	BP•H31Y11	BP•H32Y11
W02 (2NC)	BP•H14W02	BP•H19W02	BP•H31W02	BP•H32W02
W20 (2NO)	BP•H14W20	BP•H19W20	BP•H31W20	BP•H32W20
Z02 (2NC)	BP•H14Z02	BP•H19Z02	BP•H31Z02	BP•H32Z02
X12 (1NO + 2NC)	BP•H14X12	BP•H19X12	BP•H31X12	BP•H32X12
X21 (2NO + 1NC)	BP•H14X21	BP•H19X21	BP•H31X21	BP•H32X21
W03 (3NC)	BP•H14W03	BP•H19W03	BP•H31W03	BP•H32W03
W30 (3NO)	BP•H14W30	BP•H19W30	BP•H31W30	BP•H32W30

Operation diagrams: page 124 - All dimensions are in mm

Limit Switches **BP series**

Double Insulation - Plastic Casing IP65 - 40 mm. width

Electrical connection:

- BP1:** one cable inlet for PG 13,5 Cable Gland
- BP2:** one cable inlet for 1/2" NPT Cable Gland
- BP5:** one cable inlet for M20 x 1,5 Cable Gland
- BP9:** 4 poles M12 plastic connector
- BP10:** 5 poles M12 plastic connector
- BP11:** 8 poles M12 plastic connector

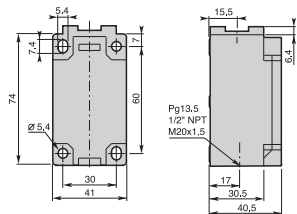

Contact Blocks

Z11 (1NO + 1NC)	BP•H33Z11	BP•H35Z11	BP•H36Z11	BP•H37Z11
X11 (1NO + 1NC)	BP•H33X11	BP•H35X11	BP•H36X11	BP•H37X11
Y11 (1NO + 1NC)	BP•H33Y11	BP•H35Y11	BP•H36Y11	BP•H37Y11
W02 (2NC)	BP•H33W02	BP•H35W02	BP•H36W02	BP•H37W02
W20 (2NO)	BP•H33W20	BP•H35W20	BP•H36W20	BP•H37W20
Z02 (2NC)	BP•H33Z02	BP•H35Z02	BP•H36Z02	BP•H37Z02
X12 (1NO + 2NC)	BP•H33X12	BP•H35X12	BP•H36X12	BP•H37X12
X21 (2NO + 1NC)	BP•H33X21	BP•H35X21	BP•H36X21	BP•H37X21
W03 (3NC)	BP•H33W03	BP•H35W03	BP•H36W03	BP•H37W03
W30 (3NO)	BP•H33W30	BP•H35W30	BP•H36W30	BP•H37W30

H33 - One way roller Ø22 steel ball bearing

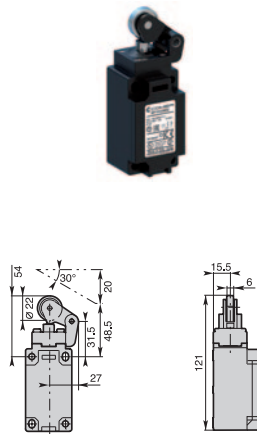

Min. actuating force
Weight

8N (30N ⇄)
185 g

H35 - One way lever with dust protection cup H35: Ø22 nylon roller H36: Ø22 stainless steel roller

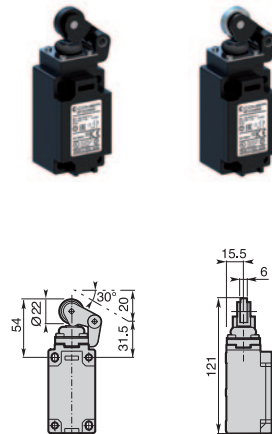

Min. actuating force
Weight

8N (30N ⇄)
180 g

H37 - One way lever with dust protection cup Ø22 steel ball bearing

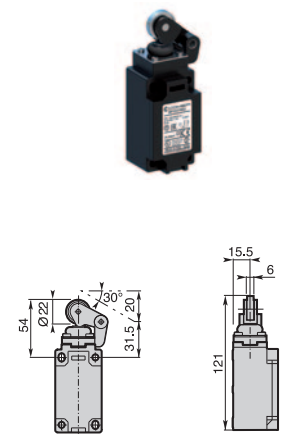

Min. actuating force
Weight

8N (30N ⇄)
180 g

H4• - Ø22 roller lever

H41: nylon roller H42: stainless steel roller

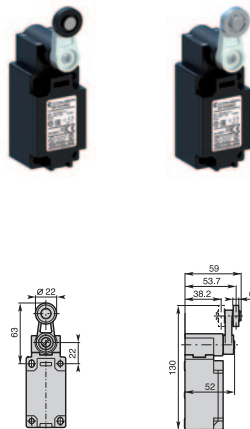

Conformity EN50041
Min. actuating torque
Weight

0,15Nm (0,30Nm ⇄)
200 g

H43 - Ø22 roller lever with steel ball bearing

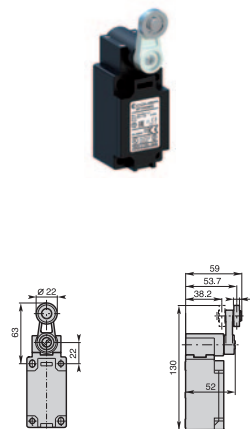

Conformity EN50041
Min. actuating torque
Weight

0,15Nm (0,30Nm ⇄)
200 g

H44 - Ø50 rubber roller lever

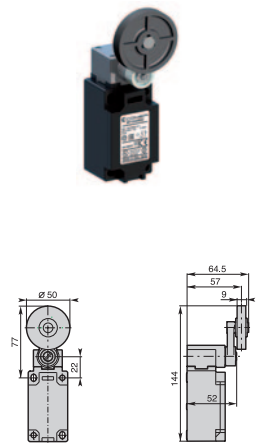

Min. actuating torque
Weight

0,15Nm (0,30Nm ⇄)
205 g

Contact Blocks

Z11 (1NO + 1NC)	BP•H41Z11	BP•H42Z11	BP•H43Z11	BP•H44Z11
X11 (1NO + 1NC)	BP•H41X11	BP•H42X11	BP•H43X11	BP•H44X11
Y11 (1NO + 1NC)	BP•H41Y11	BP•H42Y11	BP•H43Y11	BP•H44Y11
W02 (2NC)	BP•H41W02	BP•H42W02	BP•H43W02	BP•H44W02
W20 (2NO)	BP•H41W20	BP•H42W20	BP•H43W20	BP•H44W20
Z02 (2NC)	BP•H41Z02	BP•H42Z02	BP•H43Z02	BP•H44Z02
X12 (1NO + 2NC)	BP•H41X12	BP•H42X12	BP•H43X12	BP•H44X12
X21 (2NO + 1NC)	BP•H41X21	BP•H42X21	BP•H43X21	BP•H44X21
W03 (3NC)	BP•H41W03	BP•H42W03	BP•H43W03	BP•H44W03
W30 (3NO)	BP•H41W03	BP•H42W30	BP•H43W30	BP•H44W30

Operation diagrams: page 124 - All dimensions are in mm

Limit Switches **BP series**

Double Insulation - Plastic Casing IP65 - 40 mm. width

Electrical connection:

- BP1:** one cable inlet for PG 13,5 Cable Gland
- BP2:** one cable inlet for 1/2" NPT Cable Gland
- BP5:** one cable inlet for M20 x 1,5 Cable Gland
- BP9:** 4 poles M12 plastic connector
- BP10:** 5 poles M12 plastic connector
- BP11:** 8 poles M12 plastic connector

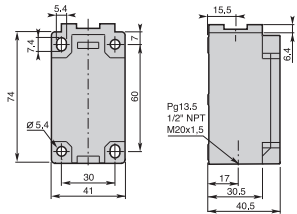

Contact Blocks

Z11 (1NO + 1NC)	BP•H51Z11	BP•H52Z11	BP•H53Z11	BP•H54Z11
X11 (1NO + 1NC)	BP•H51X11	BP•H52X11	BP•H53X11	BP•H54X11
Y11 (1NO + 1NC)	BP•H51Y11	BP•H52Y11	BP•H53Y11	BP•H54Y11
W02 (2NC)	BP•H51W02	BP•H52W02	BP•H53W02	BP•H54W02
W20 (2NO)	BP•H51W20	BP•H52W20	BP•H53W20	BP•H54W20
Z02 (2NC)	BP•H51Z02	BP•H52Z02	BP•H53Z02	BP•H54Z02
X12 (1NO + 2NC)	BP•H51X12	BP•H52X12	BP•H53X12	BP•H54X12
X21 (2NO + 1NC)	BP•H51X21	BP•H52X21	BP•H53X21	BP•H54X21
W03 (3NC)	BP•H51W03	BP•H52W03	BP•H53W03	BP•H54W03
W30 (3NO)	BP•H51W30	BP•H52W30	BP•H53W30	BP•H54W30

H5• - Adjustable Ø22 roller lever

H51: nylon roller H52: stainless steel roller

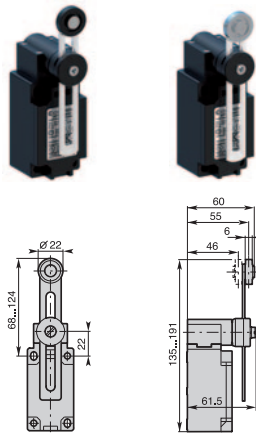

Min. actuating torque **0,15Nm (0,30Nm ⊖)**
Weight **195 g**

H53 - Adjustable Ø22 roller lever with steel ball bearing

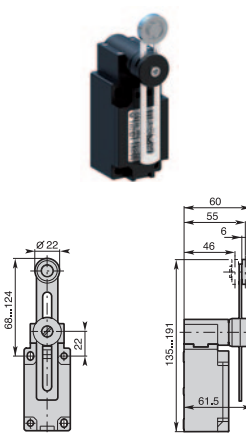

Min. actuating torque **0,15Nm (0,30Nm ⊖)**
Weight **195 g**

H54 - Adjustable Ø50 rubber roller lever

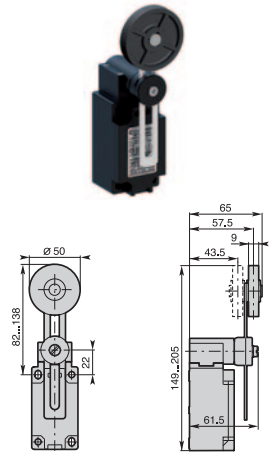

Min. actuating torque **0,15Nm (0,30Nm ⊖)**
Weight **205 g**

H61 - Nylon actuator with stainless steel spring

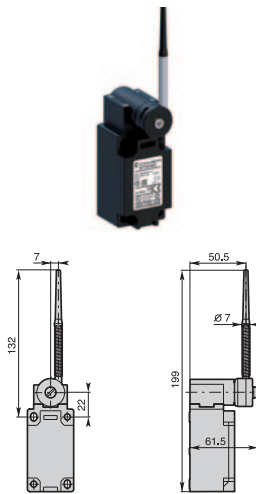

Min. actuating torque **0,15Nm**
Weight **190 g**

H62 - Stainless steel spring actuator

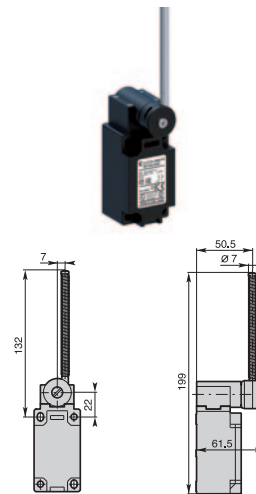

Min. actuating torque **0,15Nm**
Weight **15 g**

H7• - Adjustable Ø3 rod lever

H71: stainless steel rod H73: fiberglass rod

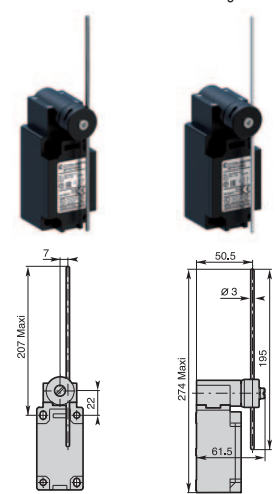

Conformity **EN50041**
Min. actuating torque **0,15Nm (0,30Nm ⊖)**
Weight **185 g**

Contact Blocks

Z11 (1NO + 1NC)	BP•H61Z11	BP•H62Z11	BP•H71Z11	BP•H73Z11
X11 (1NO + 1NC)	BP•H61X11	BP•H62X11	BP•H71X11	BP•H73X11
Y11 (1NO + 1NC)	BP•H61Y11	BP•H62Y11	BP•H71Y11	BP•H73Y11
W02 (2NC)	BP•H61W02	BP•H62W02	BP•H71W02	BP•H73W02
W20 (2NO)	BP•H61W20	BP•H62W20	BP•H71W20	BP•H73W20
Z02 (2NC)	BP•H61Z02	BP•H62Z02	BP•H71Z02	BP•H73Z02
X12 (1NO + 2NC)	BP•H61X12	BP•H62X12	BP•H71X12	BP•H73X12
X21 (2NO + 1NC)	BP•H61X21	BP•H62X21	BP•H71X21	BP•H73X21
W03 (3NC)	BP•H61W03	BP•H62W03	BP•H71W03	BP•H73W03
W30 (3NO)	BP•H61W30	BP•H62W30	BP•H71W30	BP•H73W30

Operation diagrams: page 124 - All dimensions are in mm

Limit Switches **BP series**

Double Insulation - Plastic Casing IP65 - 40 mm. width

Electrical connection:

- BP1:** one cable inlet for PG 13,5 Cable Gland
- BP2:** one cable inlet for 1/2" NPT Cable Gland
- BP5:** one cable inlet for M20 x 1,5 Cable Gland
- BP9:** 4 poles M12 plastic connector
- BP10:** 5 poles M12 plastic connector
- BP11:** 8 poles M12 plastic connector

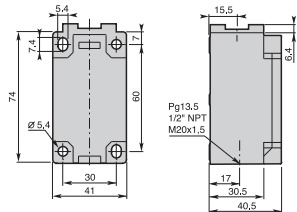

Contact Blocks

Z11 (1NO + 1NC)	BP•H72Z11	BP•H74Z11	BP•H75Z11
X11 (1NO + 1NC)	BP•H72X11	BP•H74X11	BP•H75X11
Y11 (1NO + 1NC)	BP•H72Y11	BP•H74Y11	BP•H75Y11
W02 (2NC)	BP•H72W02	BP•H74W02	BP•H75W02
W20 (2NO)	BP•H72W20	BP•H74W20	BP•H75W20
Z02 (2NC)	BP•H72Z02	BP•H74Z02	BP•H75Z02
X12 (1NO + 2NC)	BP•H72X12	BP•H74X12	BP•H75X12
X21 (2NO + 1NC)	BP•H72X21	BP•H74X21	BP•H75X21
W03 (3NC)	BP•H72W03	BP•H74W03	BP•H75W03
W30 (3NO)	BP•H72W30	BP•H74W30	BP•H75W30

H72 - Adjustable Ø6 nylon rod lever

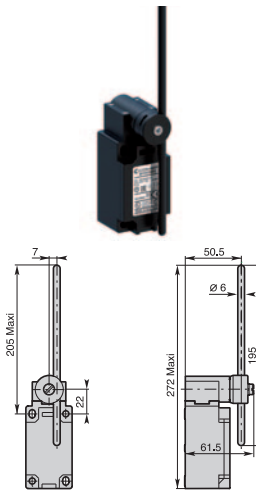

Conformity EN50041

Min. actuating torque 0,15Nm (0,30Nm ⇄)
Weight 185 g

H74 - Adjustable Ø6 fiberglass rod lever

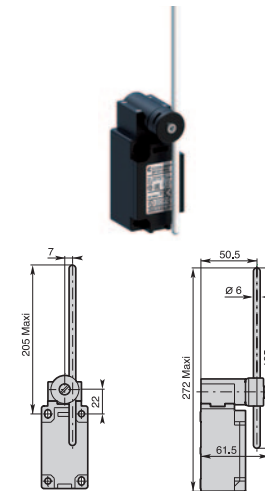

Conformity EN50041

Min. actuating torque 0,15Nm (0,30Nm ⇄)
Weight 185 g

H75 - Adjustable 3x3 square steel rod lever

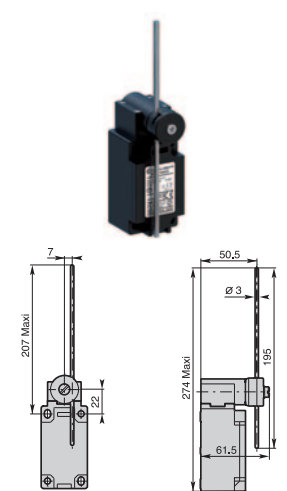

Conformity EN50041

Min. actuating torque 0,15Nm (0,30Nm ⇄)
Weight 185 g

H91 - Stainless steel spring multidirectional actuator

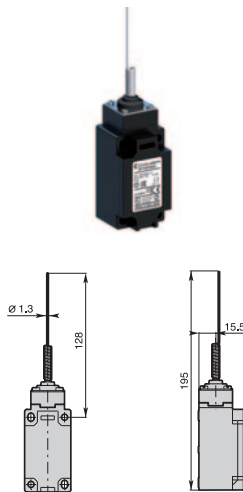

Min. actuating torque 0,18Nm
Weight 150 g

H92 - Multidirectional nylon actuator with stainless steel spring

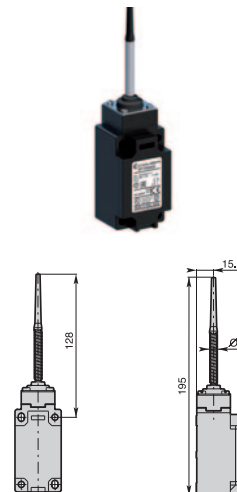

Min. actuating torque 0,18Nm
Weight 155 g

H93 - Stainless steel spring multidirectional actuator

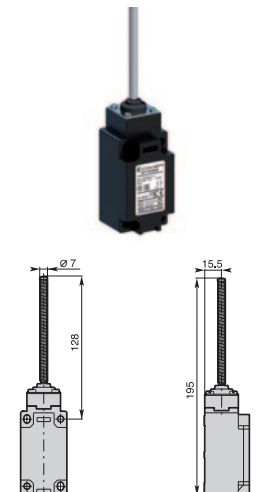

Min. actuating torque 0,18Nm
Weight 160 g

Contact Blocks

Z11 (1NO + 1NC)	BP•H91Z11	BP•H92Z11	BP•H93Z11
X11 (1NO + 1NC)	BP•H91X11	BP•H92X11	BP•H93X11
Y11 (1NO + 1NC)	BP•H91Y11	BP•H92Y11	BP•H93Y11
W02 (2NC)	BP•H91W02	BP•H92W02	BP•H93W02
W20 (2NO)	BP•H91W20	BP•H92W20	BP•H93W20
Z02 (2NC)	BP•H91Z02	BP•H92Z02	BP•H93Z02
X12 (1NO + 2NC)	BP•H91X12	BP•H92X12	BP•H93X12
X21 (2NO + 1NC)	BP•H91X21	BP•H92X21	BP•H93X21
W03 (3NC)	BP•H91W03	BP•H92W03	BP•H93W03
W30 (3NO)	BP•H91W30	BP•H92W30	BP•H93W30

Operation diagrams: page 124 - All dimensions are in mm

Limit Switches **BM series**

Summary

APPROVALS: UL 508 / CSA C22-2 N. 14 / IEC 60947-5-1



CB-SCHEME certification according to IEC 60947-5-1

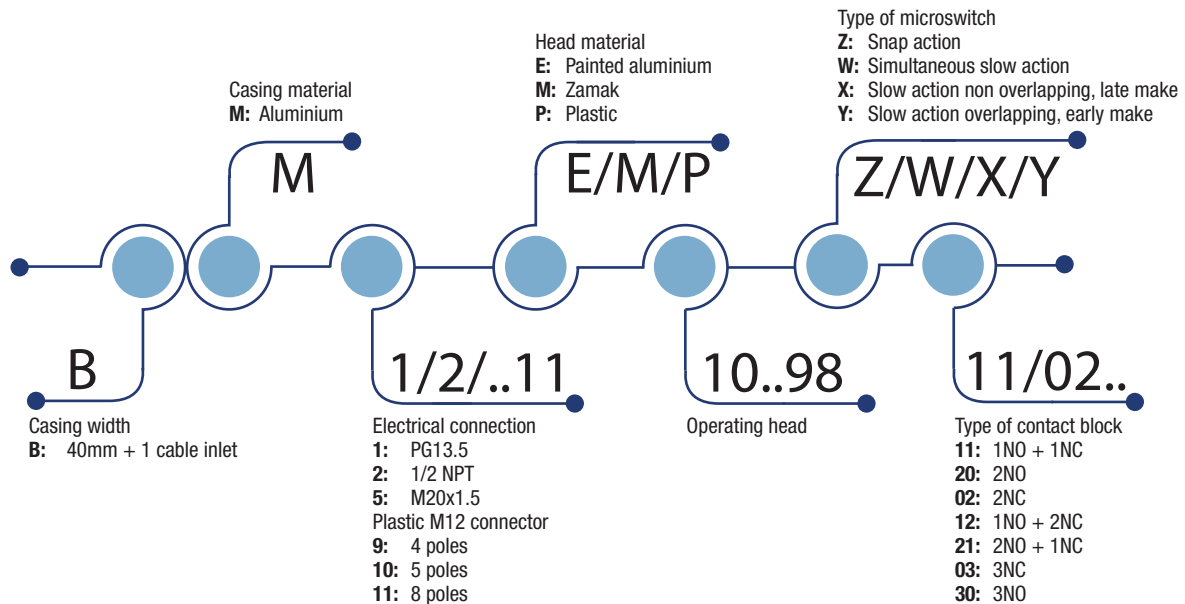

HOW IS IT MADE?

01 A variety of actuators

- Plain plunger
- Roller plunger
- Roller lever, adjustable or not, etc.

02 Wide range of heads

- Assembled using 4 x Ø4 screws

03 Casing:

- 40 mm. with dimensions acc. to EN 50041

04 Mounting screws

- 2 or 4 x M5 screws on top part

05 Cover

- 2 screws 3 pozidriv 1

06 Contact Block

- Positive opening operation
- Snap action or slow action
- Electrically separated contacts

07 Connecting terminals

- Block of 2 contacts: M3.5 (+, -) pozidriv 2 screw
- Block of 3 contacts: M3 (+, -) screw
- Screw head with captive cable clamp
- Markings conform with IEC 60947-1, IEC 60947-5-1 standards

08 Electrical connection

- 1 x threaded cable inlet suitable for cable gland or M12 connector

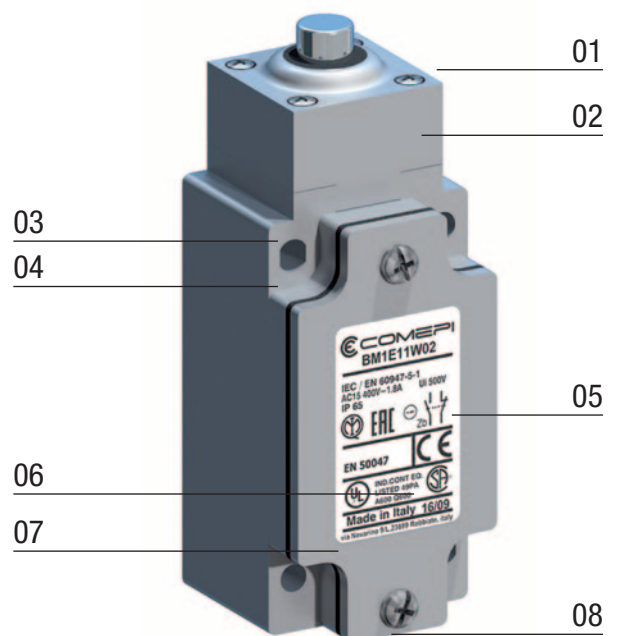

Limit Switches **BM series**

Description

APPLICATIONS

Easy to use, electromechanical limit switches offer specific qualities:

- Visible operation.
- Able to switch strong currents (10 A conventional thermal current).
- Electrically separated contacts.
- Precise operating points (consistency).
- Immune to electromagnetic disturbances.

They are purpose-built detection devices thanks to these characteristics:

- Presence/absence.
- Positioning and travel limit.
- Objects passing/counting.

DESCRIPTION

Limit switches, which are made aluminium, are mechanically more resistant and three times lighter than the ones in zinc alloy and they offer a degree of protection of IP66.

They comply with the requirements of European Directives (Low Voltage and RoHS) and are conform to European and International Standards.

The CE declaration of these products are available in the download section of website www.comepi.it or by writing to the following email address: tecnico@comepi.it
DDC02 - Limit Switches.

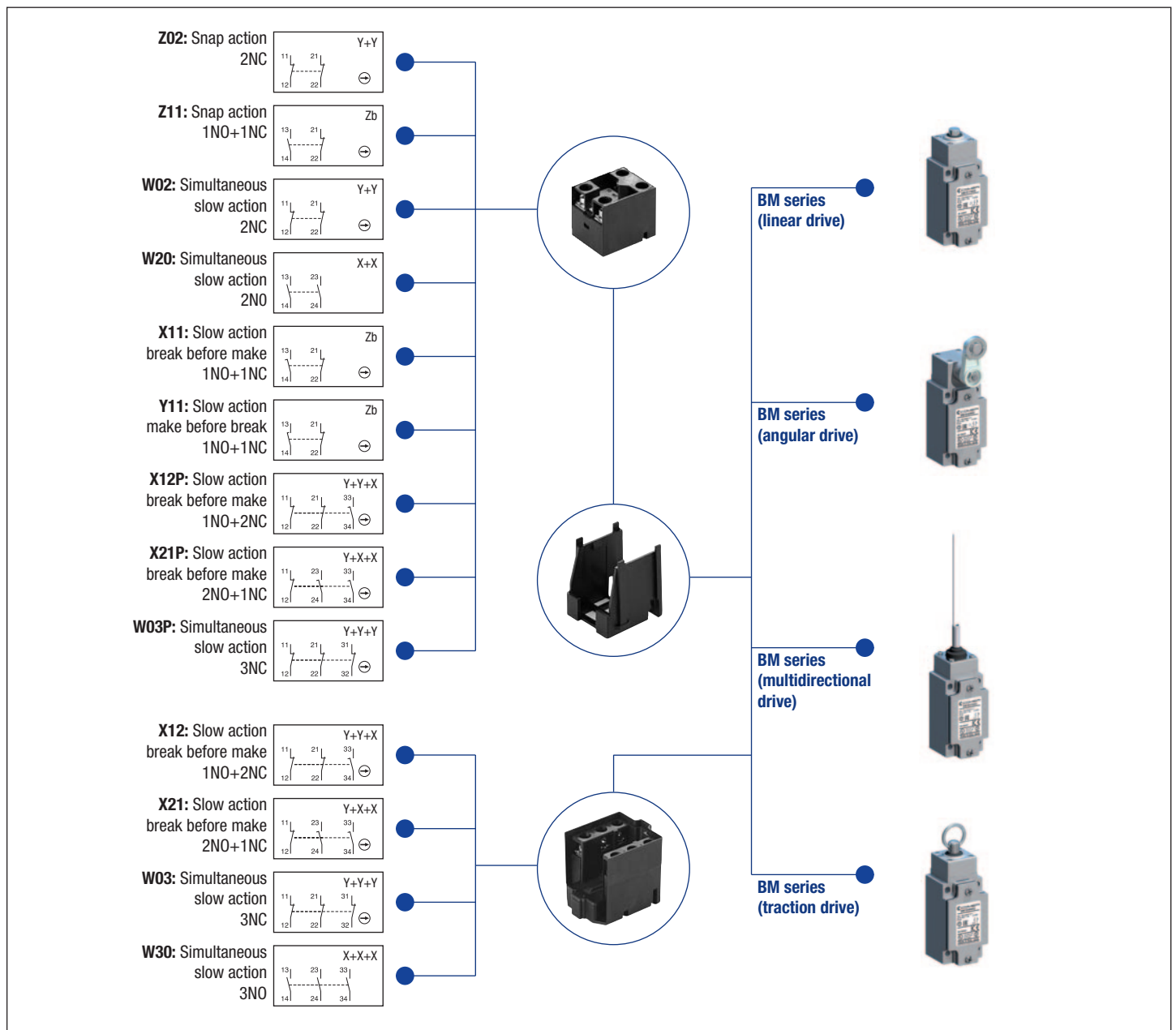

Limit Switches **BM series**

Technical Data

	BM Series	
Standards	IEC 60947-5-1 EN 60947-5-1	
Certifications - Approvals	UL - CSA - IMQ - EAC - CCC - UKCA	
Air temperature near the device		
– during operation	°C	– 25 ... + 70
– for storage	°C	– 30 ... + 80
Mounting positions	All positions are authorised	
Protection against electrical shocks (acc. to IEC 61140)	Class I	
Degree of protection (according to IEC 60529 and EN 60529)	IP 66*	

Electrical Data

Rated insulation voltage U_i - according to IEC 60947-1 and EN 60947-1 - according to UL 508 and CSA C22-2 n° 14	500 V (degree of pollution 3) (400 V for contacts type Z02) A 600, Q 600	
Rated impulse withstand voltage U_{imp} (according to IEC 60947-1 and EN 60947-1)	kV	6
Conventional free air thermal current I_{th} (according to IEC 60947-5-1) $\theta < 40\text{ °C}$	A	10
Short-circuit protection $U_e < 500\text{ V a.c.}$ - gG (gl) type fuses	A	10
Rated operational current I_e / AC-15 (according to IEC 60947-5-1)	24 V - 50/60 Hz A 120 V - 50/60 Hz A 400 V - 50/60 Hz A	10 6 4 (1.8A for contacts type X12, X21, W03, W30)
I_e / DC-13 (according to IEC 60947-5-1)	24 V - d.c. A 125 V - d.c. A 250 V - d.c. A	6 (2.8A for contacts type X12, X21, W03, W30) 0.55 0.4 (0.27A for contacts type X12, X21, W03, W30)
Switching frequency	Cycles/h	3600
Load factor		0.5
Resistance between contacts	m Ω	25
Connecting terminals	M3.5 (+, -) pozidriv 2 screw with cable clamp (M3 for 3 poles contacts type)	
Terminal for protective conductor	M3.5 (+, -) pozidriv 2 screw with cable clamp	
Connecting capacity	1 or 2 x mm ²	0.34 ... 2.5 (0.34... 1.5 for 3 poles contacts type)
Terminal marking	According to IEC 60947-5-1	
Recommended tightening torque	Metal	
Cover	0,8Nm, max 0,9	
Head	0,8Nm, max 0,9	
Microswitch	0,8Nm, max 0,9	
Mechanical durability	30 millions of operations 25 millions of operations 10 millions of operations	P11; M13; E11...13; E21...23; E31...33 M41...75; E41...75 P91...93; M14; M19; E91...93; E99
Electrical durability (according to IEC 60947-5-1)	Utilization categories AC-15 and DC-13 (Load factor of 0.5 according to curves below)	

* except for E54, E92, E93, P92, P93, M54: the degree of protection is IP65

AC-15 - Snap action

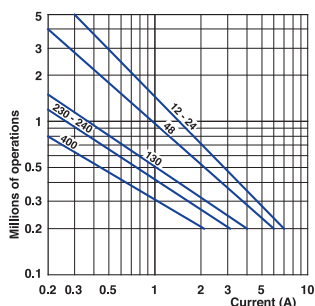

AC-15 - Slow action

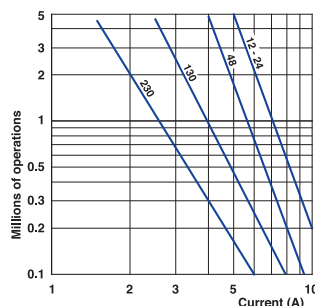

DC-13	Snap action	Slow action
	Power breaking for a durability of 5 million operating cycles	
Voltage 24 V	9.5 W	12 W
Voltage 48 V	6.8 W	9 W
Voltage 110 V	3.6 W	6 W

Limit Switches **BM series**

Technical Data

Technical data approved by IMQ

Standards	Devices conform with international IEC 60947-5-1 and European EN 60947-5-1 standards	
Degree of protection	IP 66*	
Rated insulation voltage U_i	500 V (degree of pollution 3) (400V for type Z02)	
Rated impulse withstand voltage U_{imp}	6 kV	
Conventional free air thermal current I_{th}	10 A	
Short-circuit protection - gG (gl) type fuses	10 A	
Rated operational current		
I_e / AC-15	24 V - 50/60 Hz	10 A
	400 V - 50/60 Hz	4 A (1.8A for contacts type X12, X21, W03, W30)
I_e / DC-13	24 V - d.c.	6 A (2.8A for contacts type X12, X21, W03, W30)
	125 V - d.c.	0.55 A
	250 V - d.c.	0.4 A (0.27A for contacts type X12, X21, W03, W30)

* except for E54, E92, E93, P92, P93, M54: the degree of protection is IP65

Technical data approved by UL

Standards	Devices conform with UL 508
Contact blocks type Z11, X11, Y11, W02 and Z02	
Utilization categories	A600, Q600
Contact blocks type X12, X21, W03 and W30	
Utilization categories	A600, Q600

Use 60/75°C copper (Cu) conductor only. Wire rages 14-18 AWG stranded or solid. The terminal tightening torque of 7 lbs-in / 0.78 Nm. Suitable for conduit connection only with use of adapter sleeve optionally provided or recommended by the manufacturer.

For the complete list of approved products, contact our technical department

IMPLEMENTATION

Operating head orientation

The head can be rotated each 90°. Recommended tightening torque 0,5 Nm (max 0,8 Nm).

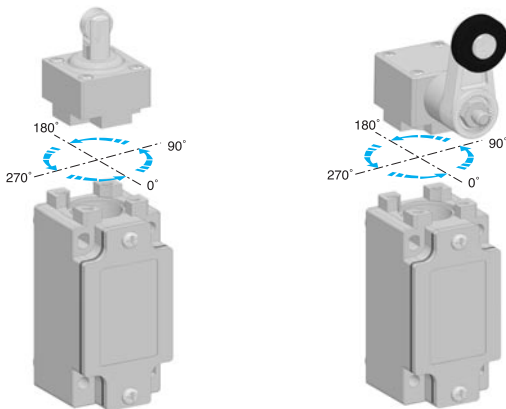

Lever adjustment

The lever of the angular actuators can be adjusted every 9° and round turned in order to obtain the maximum flexibility on the working plan. Recommended tightening torque 0,5 Nm (max 0,8 Nm).

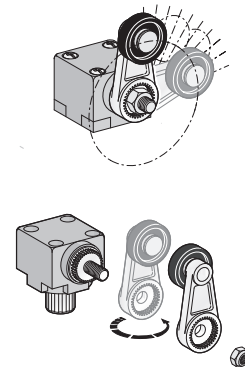

Operating mode selection (BM_E Series only)

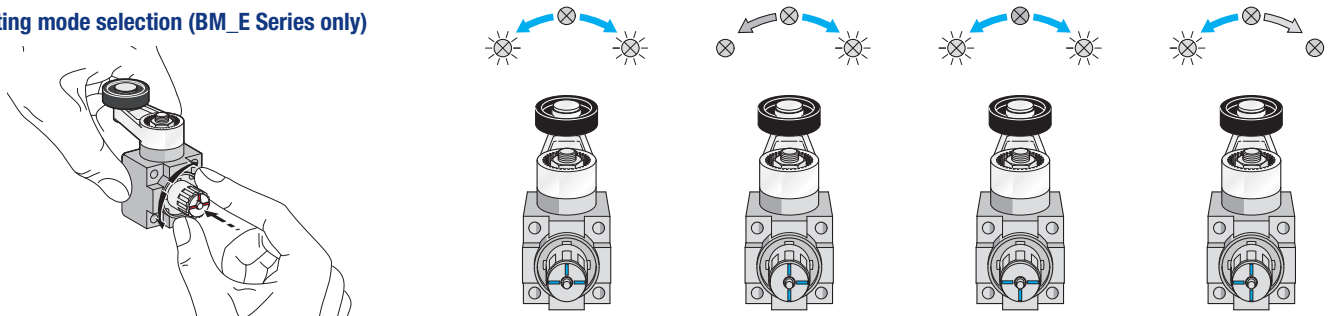

Special Versions



M12 CONNECTOR

Prewired versions with 5 or 8 poles M12 male connectors. Available with plastic threaded body. See page 117 for more details.

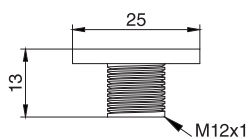

Low Temperature

The limit switches for low temperature applications are useful for refrigerated cells or equipments where the air operational temperature is very low.

These devices, made in special materials, are able to extend the operational temperature range down to -40°C, maintaining mechanical performances intact. To order add the digits "40" following the operating head indication in part number.

For example: BM1E11Z11 ▶ BM1E1140Z11

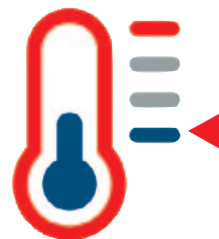

Limit Switches **BM_E** series

Metal Casing IP66 - 40 mm. width

Electrical connection:

- BM1:** one cable inlet for PG 13,5 Cable Gland
- BM2:** one cable inlet for 1/2" NPT Cable Gland
- BM5:** one cable inlet for M20 x 1,5 Cable Gland
- BM10:** 5 poles M12 plastic connector
- BM11:** 8 poles M12 plastic connector

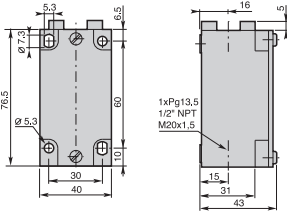

Contact Blocks

Z11 (1NO + 1NC)	BM•E11Z11	BM•E12Z11	BM•E13Z11
X11 (1NO + 1NC)	BM•E11X11	BM•E12X11	BM•E13X11
Y11 (1NO + 1NC)	BM•E11Y11	BM•E12Y11	BM•E13Y11
W02 (2NC)	BM•E11W02	BM•E12W02	BM•E13W02
W20 (2NO)	BM•E11W20	BM•E12W20	BM•E13W20
Z02 (2NC)	BM•E11Z02	BM•E12Z02	BM•E13Z02
X12 (1NO + 2NC)	BM•E11X12	BM•E12X12	BM•E13X12
X21 (2NO + 1NC)	BM•E11X21	BM•E12X21	BM•E13X21
W03 (3NC)	BM•E11W03	BM•E12W03	BM•E13W03
W30 (3NO)	BM•E11W30	BM•E12W30	BM•E13W30

E11 - Stainless steel plain plunger

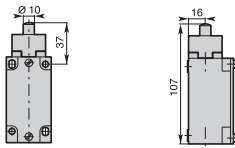

Conformity EN50041
Min. actuating force
Weight

30N (45N \ominus)
240 g

E12 - Stainless steel ball plunger

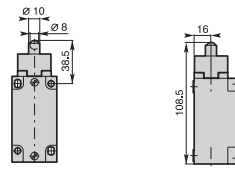

Conformity EN50041
Min. actuating force
Weight

30N (45N \ominus)
240 g

E13 - Stainless steel Ø12 roller plunger

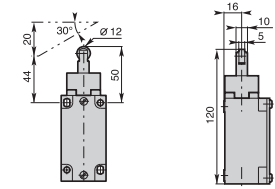

Conformity EN50041
Min. actuating force
Weight

22N (40N \ominus)
245 g

E21 - Stainless steel lateral plain plunger

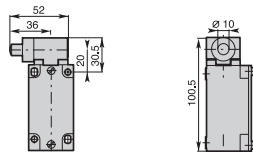

Conformity EN50041
Min. actuating force
Weight

30N (50N \ominus)
260 g

E22 - Stainless steel lateral plunger with Ø12 vertical roller

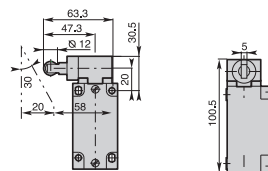

Conformity EN50041
Min. actuating force
Weight

30N (50N \ominus)
265 g

E23 - Stainless steel lateral plunger with Ø12 horizontal roller

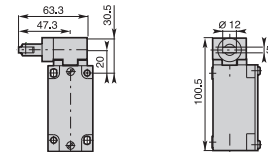

Conformity EN50041
Min. actuating force
Weight

30N (50N \ominus)
265 g

Contact Blocks

Z11 (1NO + 1NC)	BM•E21Z11	BM•E22Z11	BM•E23Z11
X11 (1NO + 1NC)	BM•E21X11	BM•E22X11	BM•E23X11
Y11 (1NO + 1NC)	BM•E21Y11	BM•E22Y11	BM•E23Y11
W02 (2NC)	BM•E21W02	BM•E22W02	BM•E23W02
W20 (2NO)	BM•E21W20	BM•E22W20	BM•E23W20
Z02 (2NC)	BM•E21Z02	BM•E22Z02	BM•E23Z02
X12 (1NO + 2NC)	BM•E21X12	BM•E22X12	BM•E23X12
X21 (2NO + 1NC)	BM•E21X21	BM•E22X21	BM•E23X21
W03 (3NC)	BM•E21W03	BM•E22W03	BM•E23W03
W30 (3NO)	BM•E21W30	BM•E22W30	BM•E23W30

Operation diagrams: page 125 - All dimensions are in mm

Limit Switches **BM_E** series

Metal Casing IP66 - 40 mm. width

Electrical connection:

- BM1:** one cable inlet for PG 13,5 Cable Gland
- BM2:** one cable inlet for 1/2" NPT Cable Gland
- BM5:** one cable inlet for M20 x 1,5 Cable Gland
- BM10:** 5 poles M12 plastic connector
- BM11:** 8 poles M12 plastic connector

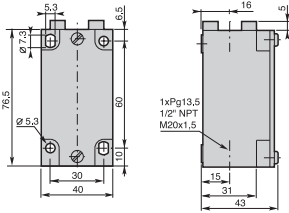

Contact Blocks

Z11 (1NO + 1NC)	BM•E31Z11	BM•E32Z11	BM•E33Z11	BM•E41Z11	BM•E42Z11
X11 (1NO + 1NC)	BM•E31X11	BM•E32X11	BM•E33X11	BM•E41X11	BM•E42X11
Y11 (1NO + 1NC)	BM•E31Y11	BM•E32Y11	BM•E33Y11	BM•E41Y11	BM•E42Y11
W02 (2NC)	BM•E31W02	BM•E32W02	BM•E33W02	BM•E41W02	BM•E42W02
W20 (2NO)	BM•E31W20	BM•E32W20	BM•E33W20	BM•E41W20	BM•E42W20
Z02 (2NC)	BM•E31Z02	BM•E32Z02	BM•E33Z02	BM•E41Z02	BM•E42Z02
X12 (1NO + 2NC)	BM•E31X12	BM•E32X12	BM•E33X12	BM•E41X12	BM•E42X12
X21 (2NO + 1NC)	BM•E31X21	BM•E32X21	BM•E33X21	BM•E41X21	BM•E42X21
W03 (3NC)	BM•E31W03	BM•E32W03	BM•E33W03	BM•E41W03	BM•E42W03
W30 (3NO)	BM•E31W30	BM•E32W30	BM•E33W30	BM•E41W30	BM•E42W30

E3• - One way lever

E31: Ø22 nylon roller E32: Ø22 stainless steel roller

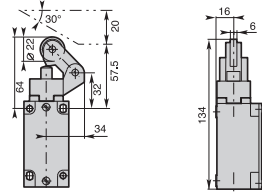

Min. actuating force
Weight

12N (40N ⇐)
280 g

E33 - One way lever Ø22 steel ball bearing

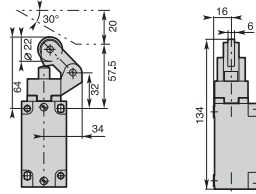

Min. actuating force
Weight

12N (40N ⇐)
280 g

E4• - Ø22 roller lever

E41: Ø22 nylon roller E42: Ø22 stainless steel roller

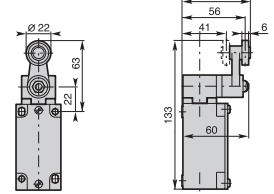

Conformity EN50041

Min. actuating torque
Weight

0,15Nm (0,30Nm ⇐)
300 g

E43 - Ø22 roller lever steel ball bearing

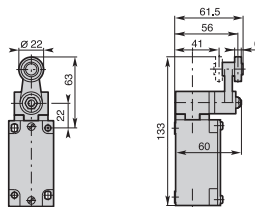

Conformity EN50041

Min. actuating torque
Weight

0,15Nm (0,30Nm ⇐)
300 g

E44 - Ø50 rubber roller lever

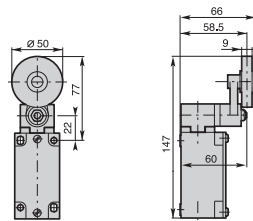

Min. actuating torque
Weight

0,15Nm (0,30Nm ⇐)
315 g

E5• - Adjustable Ø22 roller lever

E51: nylon roller E52: stainless steel roller

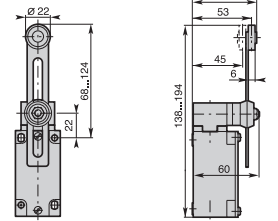
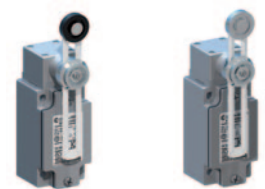

Min. actuating torque
Weight

0,15Nm (0,30Nm ⇐)
320 g

Contact Blocks

Z11 (1NO + 1NC)	BM•E43Z11	BM•E44Z11	BM•E51Z11	BM•E52Z11
X11 (1NO + 1NC)	BM•E43X11	BM•E44X11	BM•E51X11	BM•E52X11
Y11 (1NO + 1NC)	BM•E43Y11	BM•E44Y11	BM•E51Y11	BM•E52Y11
W02 (2NC)	BM•E43W02	BM•E44W02	BM•E51W02	BM•E52W02
W20 (2NO)	BM•E43W20	BM•E44W20	BM•E51W20	BM•E52W20
Z02 (2NC)	BM•E43Z02	BM•E44Z02	BM•E51Z02	BM•E52Z02
X12 (1NO + 2NC)	BM•E43X12	BM•E44X12	BM•E51X12	BM•E52X12
X21 (2NO + 1NC)	BM•E43X21	BM•E44X21	BM•E51X21	BM•E52X21
W03 (3NC)	BM•E43W03	BM•E44W03	BM•E51W03	BM•E52W03
W30 (3NO)	BM•E43W30	BM•E44W30	BM•E51W30	BM•E52W30

Operation diagrams: page 125 - All dimensions are in mm

Limit Switches **BM_E** series

Metal Casing IP66 - 40 mm. width

Electrical connection:

- BM1:** one cable inlet for PG 13,5 Cable Gland
- BM2:** one cable inlet for 1/2" NPT Cable Gland
- BM5:** one cable inlet for M20 x 1,5 Cable Gland
- BM10:** 5 poles M12 plastic connector
- BM11:** 8 poles M12 plastic connector

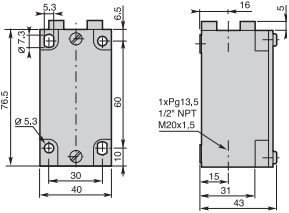

Contact Blocks

aZ11 (1NO + 1NC)	BM•E53Z11	BM•E54Z11	BM•E61Z11
X11 (1NO + 1NC)	BM•E53X11	BM•E54X11	BM•E61X11
Y11 (1NO + 1NC)	BM•E53Y11	BM•E54Y11	BM•E61Y11
W02 (2NC)	BM•E53W02	BM•E54W02	BM•E61W02
W20 (2NO)	BM•E53W20	BM•E54W20	BM•E61W20
Z02 (2NC)	BM•E53Z02	BM•E54Z02	BM•E61Z02
X12 (1NO + 2NC)	BM•E53X12	BM•E54X12	BM•E61X12
X21 (2NO + 1NC)	BM•E53X21	BM•E54X21	BM•E61X21
W03 (3NC)	BM•E53W03	BM•E54W03	BM•E61W03
W30 (3NO)	BM•E53W30	BM•E54W30	BM•E61W30

E53 - Adjustable Ø22 roller lever with steel ball bearing

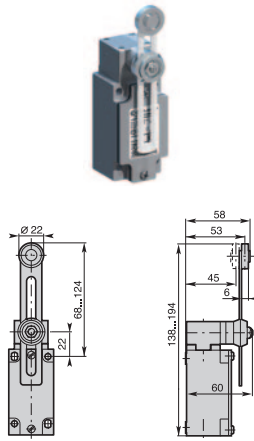

Min. actuating torque 0,15Nm (0,30Nm \ominus)
Weight 320 g

E54 - Adjustable Ø50 rubber roller lever

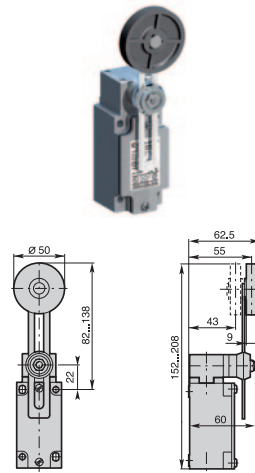

Min. actuating torque 0,15Nm (0,30Nm \ominus)
Weight 325 g

E61 - Nylon actuator with stainless steel spring

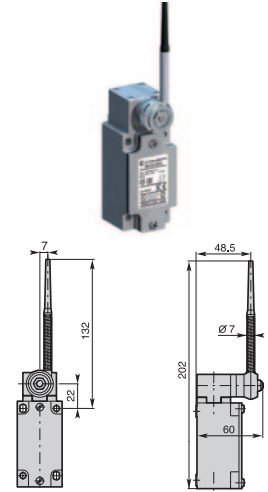

Min. actuating torque 0,15Nm
Weight 305 g

E62 - Stainless steel spring actuator

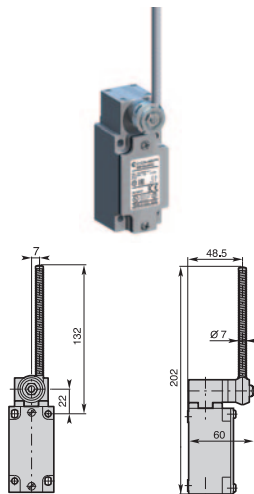

Min. actuating torque 0,15Nm
Weight 310 g

E7• - Adjustable Ø3 rod lever

E71: stainless steel rod E73: fiberglass rod

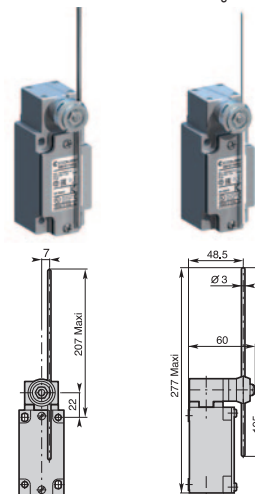

Conformity EN50041
Min. actuating torque 0,15Nm (0,30Nm \ominus)
Weight 305 g

E72 - Adjustable Ø6 nylon rod lever

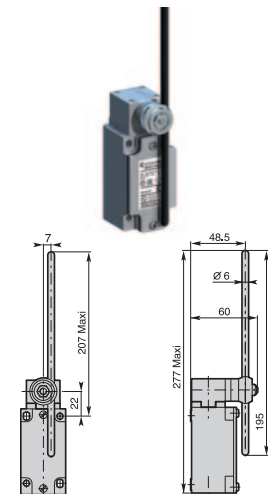

Conformity EN50041
Min. actuating torque 0,15Nm (0,30Nm \ominus)
Weight 300 g

Contact Blocks

Z11 (1NO + 1NC)	BM•E62Z11	BM•E71Z11	BM•E73Z11	BM•E72Z11
X11 (1NO + 1NC)	BM•E62X11	BM•E71X11	BM•E73X11	BM•E72X11
Y11 (1NO + 1NC)	BM•E62Y11	BM•E71Y11	BM•E73Y11	BM•E72Y11
W02 (2NC)	BM•E62W02	BM•E71W02	BM•E73W02	BM•E72W02
W20 (2NO)	BM•E62W20	BM•E71W20	BM•E73W20	BM•E72W20
Z02 (2NC)	BM•E62Z02	BM•E71Z02	BM•E73Z02	BM•E72Z02
X12 (1NO + 2NC)	BM•E62X12	BM•E71X12	BM•E73X12	BM•E72X12
X21 (2NO + 1NC)	BM•E62X21	BM•E71X21	BM•E73X21	BM•E72X21
W03 (3NC)	BM•E62W03	BM•E71W03	BM•E73W03	BM•E72W03
W30 (3NO)	BM•E62W30	BM•E71W30	BM•E73W30	BM•E72W30

Operation diagrams: page 125 - All dimensions are in mm

Limit Switches **BM_E** series

Metal Casing IP66 - 40 mm. width

Electrical connection:

- BM1:** one cable inlet for PG 13,5 Cable Gland
- BM2:** one cable inlet for 1/2" NPT Cable Gland
- BM5:** one cable inlet for M20 x 1,5 Cable Gland
- BM10:** 5 poles M12 plastic connector
- BM11:** 8 poles M12 plastic connector

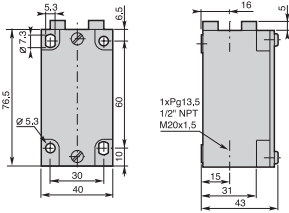

Contact Blocks

Z11 (1NO + 1NC)	BM•E74Z11	BM•E75Z11	BM•E91Z11
X11 (1NO + 1NC)	BM•E74X11	BM•E75X11	BM•E91X11
Y11 (1NO + 1NC)	BM•E74Y11	BM•E75Y11	BM•E91Y11
W02 (2NC)	BM•E74W02	BM•E75W02	BM•E91W02
W20 (2NO)	BM•E74W20	BM•E75W20	BM•E91W20
Z02 (2NC)	BM•E74Z02	BM•E75Z02	BM•E91Z02
X12 (1NO + 2NC)	BM•E74X12	BM•E75X12	BM•E91X12
X21 (2NO + 1NC)	BM•E74X21	BM•E75X21	BM•E91X21
W03 (3NC)	BM•E74W03	BM•E75W03	BM•E91W03
W30 (3NO)	BM•E74W30	BM•E75W30	BM•E91W30

E74 - Adjustable Ø6 fiberglass rod lever

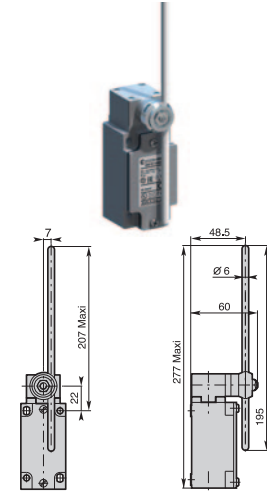

Conformity EN50041

Min. actuating torque **0,15Nm (0,30Nm ⊖)**
Weight **300 g**

E75 - Adjustable 3x3 square steel rod lever

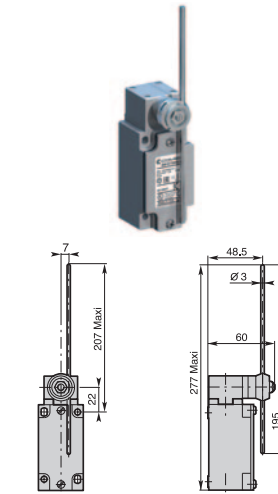

Conformity EN50041

Min. actuating torque **0,15Nm (0,30Nm ⊖)**
Weight **305 g**

E91 - Stainless steel spring multidirectional actuator

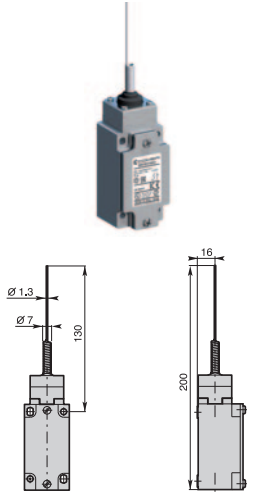

Min. actuating torque **0,18Nm**
Weight **230 g**

E92 - Multidirectional nylon actuator with stainless steel spring

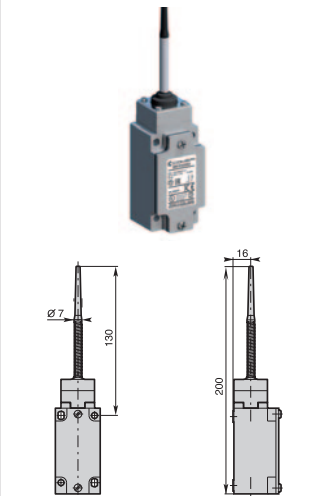

Min. actuating torque **0,18Nm**
Weight **230 g**

E93 - Stainless steel spring multidirectional actuator

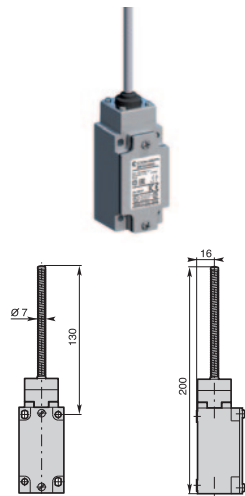

Min. actuating torque **0,18Nm**
Weight **235 g**

E99 - Pull action with ring

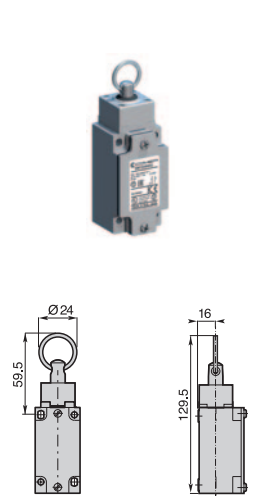

Min. actuating force **25N**
Weight **245 g**

Contact Blocks

Z11 (1NO + 1NC)	BM•E92Z11	BM•E93Z11	BM•E99Z11A
X11 (1NO + 1NC)	BM•E92X11	BM•E93X11	BM•E99X11A
Y11 (1NO + 1NC)	BM•E92Y11	BM•E93Y11	BM•E99Y11A
W02 (2NC)	BM•E92W02	BM•E93W02	BM•E99W02A
W20 (2NO)	BM•E92W20	BM•E93W20	BM•E99W20A
Z02 (2NC)	BM•E92Z02	BM•E93Z02	
X12 (1NO + 2NC)	BM•E92X12	BM•E93X12	BM•E99X12A
X21 (2NO + 1NC)	BM•E92X21	BM•E93X21	BM•E99X21A
W03 (3NC)	BM•E92W03	BM•E93W03	BM•E99W03A
W30 (3NO)	BM•E92W30	BM•E93W30	BM•E99W30A

Operation diagrams: page 125 - All dimensions are in mm

Limit Switches **BM_P** series

Metal Casing IP66 - 40 mm. width

Electrical connection:

- BM1:** one cable inlet for PG 13,5 Cable Gland
- BM2:** one cable inlet for 1/2" NPT Cable Gland
- BM5:** one cable inlet for M20 x 1,5 Cable Gland
- BM10:** 5 poles M12 plastic connector
- BM11:** 8 poles M12 plastic connector

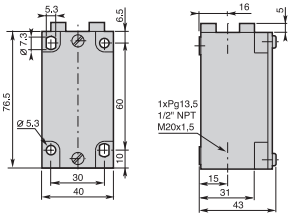

Contact Blocks

Z11 (1NO + 1NC)	BM•P11Z11	BM•P92Z11	BM•P93Z11
X11 (1NO + 1NC)	BM•P11X11	BM•P92X11	BM•P93X11
Y11 (1NO + 1NC)	BM•P11Y11	BM•P92Y11	BM•P93Y11
W02 (2NC)	BM•P11W02	BM•P92W02	BM•P93W02
W20 (2NO)	BM•P11W20	BM•P92W20	BM•P93W20
Z02 (2NC)	BM•P11Z02	BM•P92Z02	BM•P93Z02
X12 (1NO + 2NC)	BM•P11X12	BM•P92X12	BM•P93X12
X21 (2NO + 1NC)	BM•P11X21	BM•P92X21	BM•P93X21
W03 (3NC)	BM•P11W03	BM•P92W03	BM•P93W03
W30 (3NO)	BM•P11W30	BM•P92W30	BM•P93W30

P11 - Plain plunger

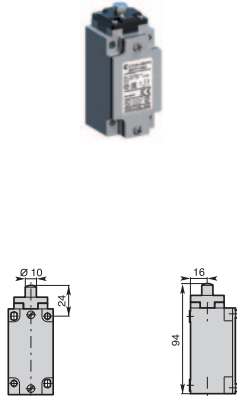

Min. actuating force
Weight

30N (45N ⊖)
220 g

P92 - Multidirectional nylon actuator with stainless steel spring

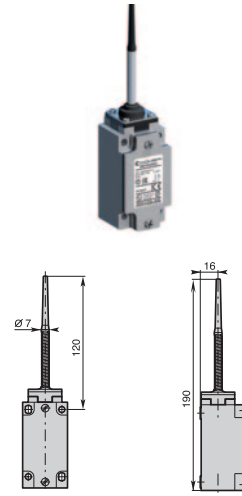

Min. actuating torque
Weight

0,18Nm
210 g

P93 - Stainless steel spring multidirectional actuator



Min. actuating torque
Weight

0,18Nm
215 g

Limit Switches **BM_M** series

Metal Casing IP66 - 40 mm. width

Electrical connection:

- BM1:** one cable inlet for PG 13,5 Cable Gland
- BM2:** one cable inlet for 1/2" NPT Cable Gland
- BM5:** one cable inlet for M20 x 1,5 Cable Gland
- BM10:** 5 poles M12 plastic connector
- BM11:** 8 poles M12 plastic connector

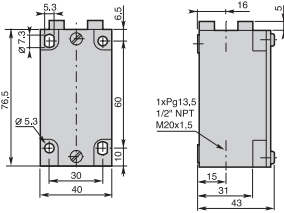

Contact Blocks

Z11 (1NO + 1NC)	BM•M13Z11	BM•M14Z11	BM•M19Z11
X11 (1NO + 1NC)	BM•M13X11	BM•M14X11	BM•M19X11
Y11 (1NO + 1NC)	BM•M13Y11	BM•M14Y11	BM•M19Y11
W02 (2NC)	BM•M13W02	BM•M14W02	BM•M19W02
W20 (2NO)	BM•M13W20	BM•M14W20	BM•M19W20
Z02 (2NC)	BM•M13Z02	BM•M14Z02	BM•M19Z02
X12 (1NO + 2NC)	BM•M13X12	BM•M14X12	BM•M19X12
X21 (2NO + 1NC)	BM•M13X21	BM•M14X21	BM•M19X21
W03 (3NC)	BM•M13W03	BM•M14W03	BM•M19W03
W30 (3NO)	BM•M13W30	BM•M14W30	BM•M19W30

M13 - Steel roller plunger

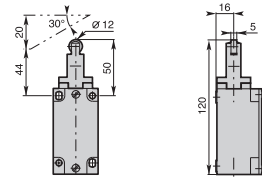

Conformity EN50041
Min. actuating force
Weight

22N (40N ⊖)
265 g

M14 - Plain steel plunger with dust protection cup

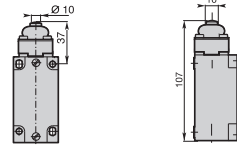

Conformity EN50041
Min. actuating force
Weight

30N (45N ⊖)
255 g

M19 - Steel roller plunger with dust protection cup

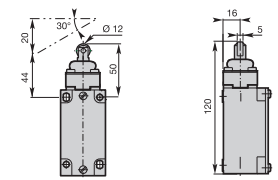

Conformity EN50041
Min. actuating force
Weight

22N (40N ⊖)
265 g

M41 - Ø22 nylon roller lever

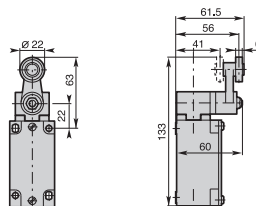

Conformity EN50041
Min. actuating torque
Weight

0,15Nm (0,30Nm ⊖)
300 g

M42 - Ø22 stainless steel roller lever

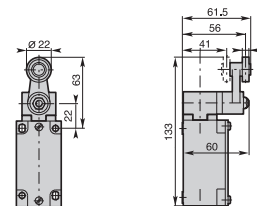

Conformity EN50041
Min. actuating torque
Weight

0,15Nm (0,30Nm ⊖)
300 g

M43 - Ø22 roller lever with steel ball bearing

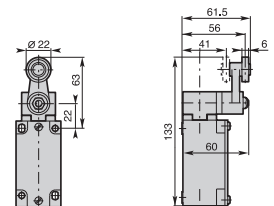

Conformity EN50041
Min. actuating torque
Weight

0,15Nm (0,30Nm ⊖)
300 g

Contact Blocks

Z11 (1NO + 1NC)	BM•M41Z11	BM•M42Z11	BM•M43Z11
X11 (1NO + 1NC)	BM•M41X11	BM•M42X11	BM•M43X11
Y11 (1NO + 1NC)	BM•M41Y11	BM•M42Y11	BM•M43Y11
W02 (2NC)	BM•M41W02	BM•M42W02	BM•M43W02
W20 (2NO)	BM•M41W20	BM•M42W20	BM•M43W20
Z02 (2NC)	BM•M41Z02	BM•M42Z02	BM•M43Z02
X12 (1NO + 2NC)	BM•M41X12	BM•M42X12	BM•M43X12
X21 (2NO + 1NC)	BM•M41X21	BM•M42X21	BM•M43X21
W03 (3NC)	BM•M41W03	BM•M42W03	BM•M43W03
W30 (3NO)	BM•M41W30	BM•M42W30	BM•M43W30

Operation diagrams: page 125 - All dimensions are in mm

Limit Switches **BM_M** series

Metal Casing IP66 - 40 mm. width

Electrical connection:

- BM1:** one cable inlet for PG 13,5 Cable Gland
- BM2:** one cable inlet for 1/2" NPT Cable Gland
- BM5:** one cable inlet for M20 x 1,5 Cable Gland
- BM10:** 5 poles M12 plastic connector
- BM11:** 8 poles M12 plastic connector

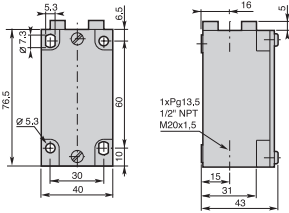

Contact Blocks

Z11 (1NO + 1NC)	BM•M62Z11	BM•M71Z11	BM•M72Z11
X11 (1NO + 1NC)	BM•M62X11	BM•M71X11	BM•M72X11
Y11 (1NO + 1NC)	BM•M62Y11	BM•M71Y11	BM•M72Y11
W02 (2NC)	BM•M62W02	BM•M71W02	BM•M72W02
W20 (2NO)	BM•M62W20	BM•M71W20	BM•M72W20
Z02 (2NC)	BM•M62Z02	BM•M71Z02	BM•M72Z02
X12 (1NO + 2NC)	BM•M62X12	BM•M71X12	BM•M72X12
X21 (2NO + 1NC)	BM•M62X21	BM•M71X21	BM•M72X21
W03 (3NC)	BM•M62W03	BM•M71W03	BM•M72W03
W30 (3NO)	BM•M62W30	BM•M71W30	BM•M72W30

M62 - Stainless steel spring actuator

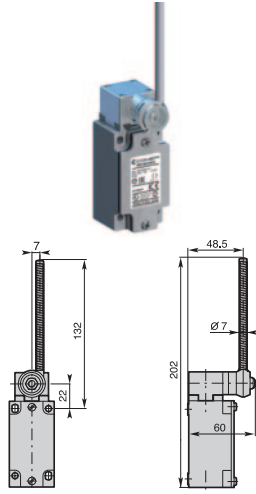

Min. actuating torque **0,15Nm**
Weight **325 g**

M71 - Adjustable Ø3 stainless steel rod lever

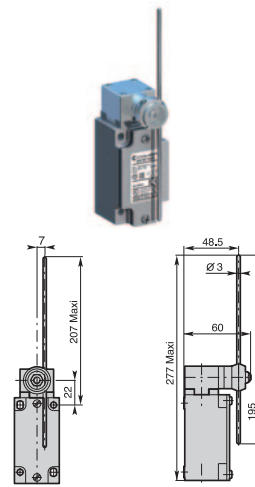

Conformity EN50041
Min. actuating torque **0,15Nm (0,30Nm ⇄)**
Weight **325 g**

M72 - Adjustable Ø6 nylon rod lever

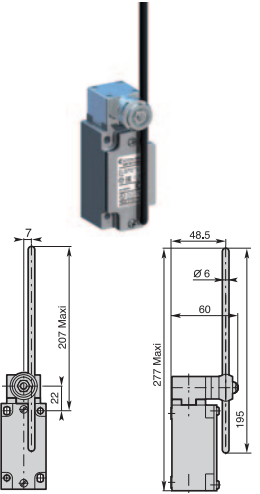

Conformity EN50041
Min. actuating torque **0,15Nm (0,30Nm ⇄)**
Weight **325 g**

M73 - Adjustable Ø3 fiberglass rod lever

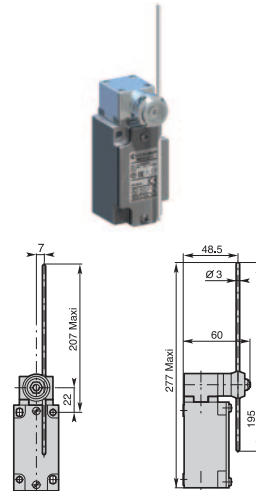

Conformity EN50041
Min. actuating torque **0,15Nm (0,30Nm ⇄)**
Weight **325 g**

M74 - Adjustable Ø6 fiberglass rod lever

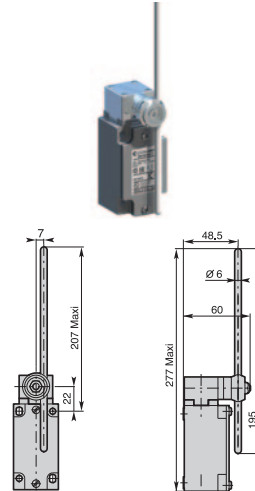

Conformity EN50041
Min. actuating torque **0,15Nm (0,30Nm ⇄)**
Weight **325 g**

M75 - Adjustable 3x3 square steel rod lever

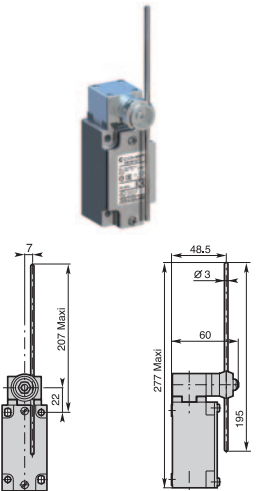

Conformity EN50041
Min. actuating torque **0,15Nm (0,30Nm ⇄)**
Weight **325 g**

Contact Blocks

Z11 (1NO + 1NC)	BM•M73Z11	BM•M74Z11	BM•M75Z11
X11 (1NO + 1NC)	BM•M73X11	BM•M74X11	BM•M75X11
Y11 (1NO + 1NC)	BM•M73Y11	BM•M74Y11	BM•M75Y11
W02 (2NC)	BM•M73W02	BM•M74W02	BM•M75W02
W20 (2NO)	BM•M73W20	BM•M74W20	BM•M75W20
Z02 (2NC)	BM•M73Z02	BM•M74Z02	BM•M75Z02
X12 (1NO + 2NC)	BM•M73X12	BM•M74X12	BM•M75X12
X21 (2NO + 1NC)	BM•M73X21	BM•M74X21	BM•M75X21
W03 (3NC)	BM•M73W03	BM•M74W03	BM•M75W03
W30 (3NO)	BM•M73W30	BM•M74W30	BM•M75W30

Operation diagrams: page 125 - All dimensions are in mm

Limit Switches **CM series**

Summary

APPROVALS: UL 508 / CSA C22-2 N. 14 / IEC 60947-5-1



CB-SCHEME certification according to IEC 60947-5-1

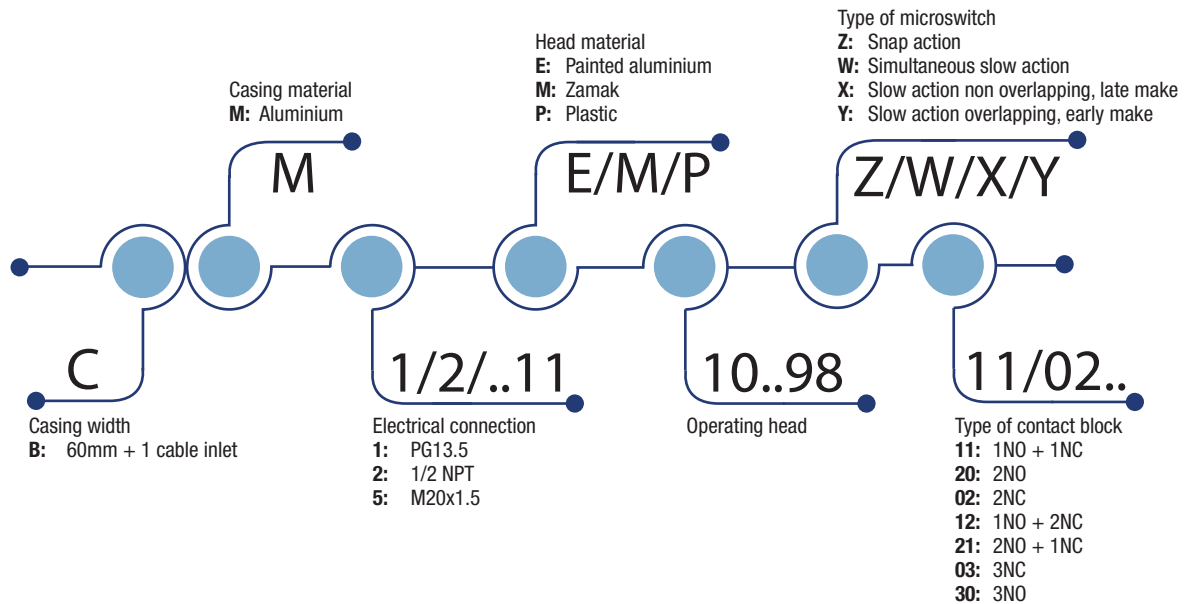

HOW IS IT MADE?

01 A variety of actuators

- Plain plunger
- Roller plunger
- Roller lever, adjustable or not, etc.

02 Wide range of heads

- Assembled using 4 x Ø4 screws

03 Casing:

- 60 mm. with dimensions acc. to EN 50041

04 Mounting screws

- 2 x M5 screws on top part

05 Cover

- 4 screws 3 pozidriv 1

06 Contact Block

- Positive opening operation
- Snap action or slow action
- Electrically separated contacts

07 Connecting terminals

- Block of 2 contacts: M3.5 (+, -) pozidriv 2 screw
- Block of 3 contacts: M3 (+, -) screw
- Screw head with captive cable clamp
- Markings conform with IEC 60947-1, IEC 60947-5-1 standards

08 Electrical connection

- 3 x threaded cable inlets suitable for cable gland

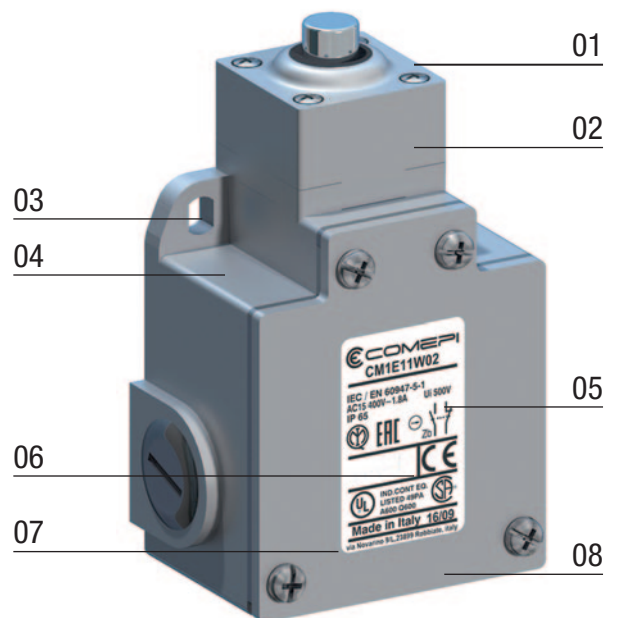

Limit Switches **CM series**

Description

APPLICATIONS

Easy to use, electromechanical limit switches offer specific qualities:

- Visible operation.
- Able to switch strong currents (10 A conventional thermal current).
- Electrically separated contacts.
- Precise operating points (consistency).
- Immune to electromagnetic disturbances.

They are purpose-built detection devices thanks to these characteristics:

- Presence/absence.
- Positioning and travel limit.
- Objects passing/counting.

DESCRIPTION

Limit switches, which are made aluminium, are mechanically more resistant and three times lighter than the ones in zinc alloy and they offer a degree of protection of IP66.

They comply with the requirements of European Directives (Low Voltage and RoHS) and are conform to European and International Standards.

The CE declaration of these products are available in the download section of website www.comepi.it or by writing to the following email address: tecnico@comepi.it
DDC02 - Limit Switches.

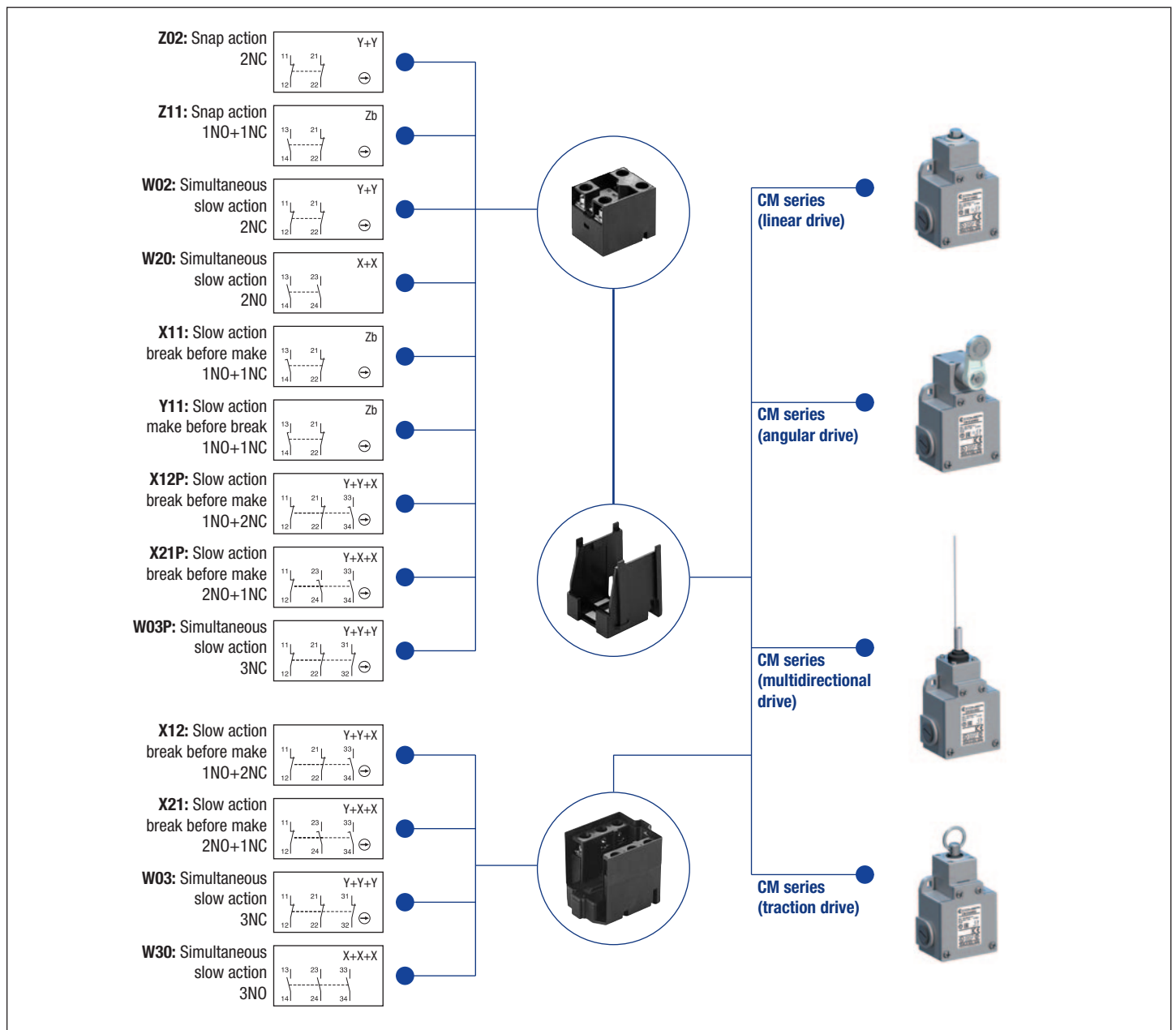

Limit Switches **CM series**

Technical Data

	CM Series	
Standards	IEC 60947-5-1 EN 60947-5-1	
Certifications - Approvals	UL - CSA - IMQ - EAC - CCC - UKCA	
Air temperature near the device		
– during operation	°C	– 25 ... + 70
– for storage	°C	– 30 ... + 80
Mounting positions	All positions are authorised	
Protection against electrical shocks (acc. to IEC 61140)	Class I	
Degree of protection (according to IEC 60529 and EN 60529)	IP 66*	

Electrical Data

Rated insulation voltage U_i - according to IEC 60947-1 and EN 60947-1 - according to UL 508 and CSA C22-2 n° 14	500 V (degree of pollution 3) (400 V for contacts type Z02) A 600, Q 600	
Rated impulse withstand voltage U_{imp} (according to IEC 60947-1 and EN 60947-1)	kV	6
Conventional free air thermal current I_{th} (according to IEC 60947-5-1) $\theta < 40$ °C	A	10
Short-circuit protection $U_e < 500$ V a.c. - gG (gl) type fuses	A	10
Rated operational current I_e / AC-15 (according to IEC 60947-5-1)	24 V - 50/60 Hz A 120 V - 50/60 Hz A 400 V - 50/60 Hz A	10 6 4 (1.8A for contacts type X12, X21, W03, W30)
I_e / DC-13 (according to IEC 60947-5-1)	24 V - d.c. A 125 V - d.c. A 250 V - d.c. A	6 (2.8A for contacts type X12, X21, W03, W30) 0.55 0.4 (0.27A for contacts type X12, X21, W03, W30)
Switching frequency	Cycles/h	3600
Load factor		0.5
Resistance between contacts	m Ω	25
Connecting terminals	M3.5 (+, -) pozidriv 2 screw with cable clamp (M3 for 3 poles contacts type)	
Terminal for protective conductor	M3.5 (+, -) pozidriv 2 screw with cable clamp	
Connecting capacity	1 or 2 x mm ²	0.34 ... 2.5 (0.34... 1.5 for 3 poles contacts type)
Terminal marking	According to IEC 60947-5-1	
Recommended tightening torque	Metal	
Cover	0,8Nm, max 0,9	
Head	0,8Nm, max 0,9	
Microswitch	0,8Nm, max 0,9	
Mechanical durability	30 millions of operations 25 millions of operations 10 millions of operations	P11; M13; E11...13; E21...23; E31...33 M41...75; E41...75 P91...93; M14; M19; E91...93; E99
Electrical durability (according to IEC 60947-5-1)	Utilization categories AC-15 and DC-13 (Load factor of 0.5 according to curves below)	

* except for E54, E92, E93, P92, P93, M54: the degree of protection is IP65

AC-15 - Snap action

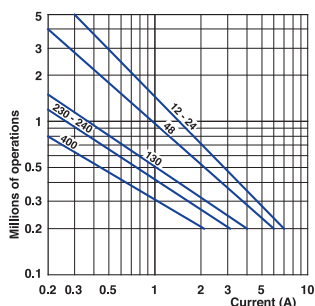

AC-15 - Slow action

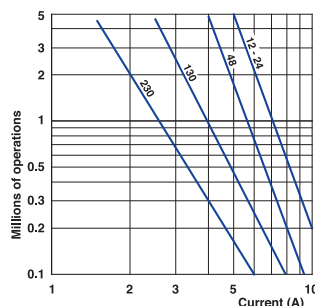

DC-13	Snap action	Slow action
		Power breaking for a durability of 5 million operating cycles
Voltage 24 V	9.5 W	12 W
Voltage 48 V	6.8 W	9 W
Voltage 110 V	3.6 W	6 W

Limit Switches **CM series**

Technical Data

Technical data approved by IMQ

Standards	Devices conform with international IEC 60947-5-1 and European EN 60947-5-1 standards	
Degree of protection	IP 66*	
Rated insulation voltage U_i	500 V (degree of pollution 3) (400V for type Z02)	
Rated impulse withstand voltage U_{imp}	6 kV	
Conventional free air thermal current I_{th}	10 A	
Short-circuit protection - gG (gl) type fuses	10 A	
Rated operational current		
I_e / AC-15	24 V - 50/60 Hz	10 A
	400 V - 50/60 Hz	4 A (1.8A for contacts type X12, X21, W03, W30)
I_e / DC-13	24 V - d.c.	6 A (2.8A for contacts type X12, X21, W03, W30)
	125 V - d.c.	0.55 A
	250 V - d.c.	0.4 A (0.27A for contacts type X12, X21, W03, W30)

* except for E54, E92, E93, P92, P93, M54: the degree of protection is IP65

Technical data approved by UL

Standards	Devices conform with UL 508
Contact blocks type Z11, X11, Y11, W02 and Z02	
Utilization categories	A600, Q600
Contact blocks type X12, X21, W03 and W30	
Utilization categories	A600, Q600

Use 60/75°C copper (Cu) conductor only. Wire rages 14-18 AWG stranded or solid. The terminal tightening torque of 7 lbs-in / 0.78 Nm. Suitable for conduit connection only with use of adapter sleeve optionally provided or recommended by the manufacturer.

For the complete list of approved products, contact our technical department

IMPLEMENTATION

Operating head orientation

The head can be rotated each 90°. Recommended tightening torque 0,5 Nm (max 0,8 Nm).

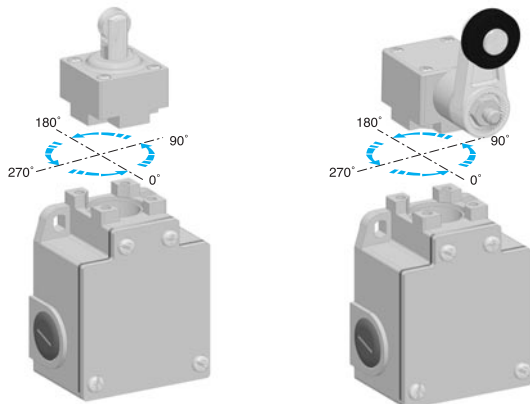

Lever adjustment

The lever of the angular actuators can be adjusted every 9° and round turned in order to obtain the maximum flexibility on the working plan. Recommended tightening torque 0,5 Nm (max 0,8 Nm).

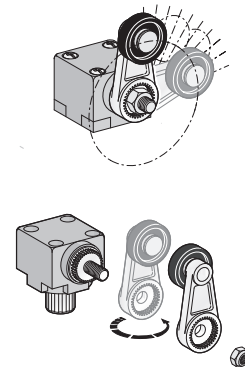

Operating mode selection (CM_E Series only)

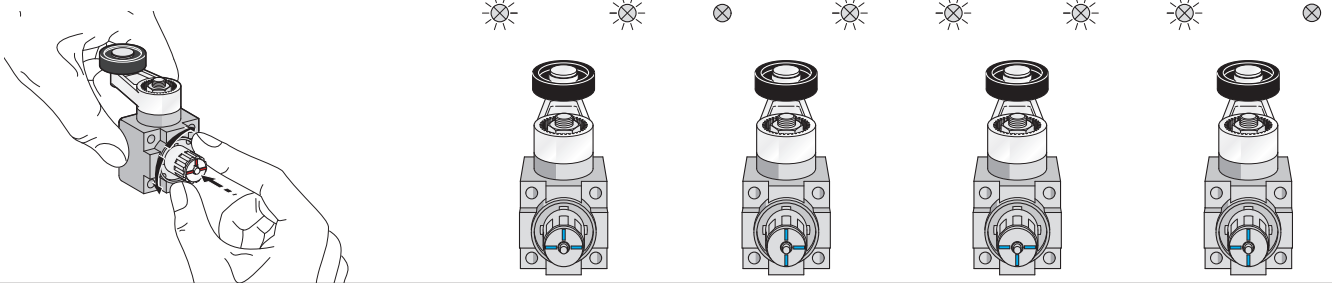

Special Versions

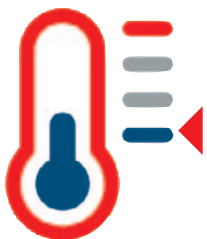

Low Temperature

The limit switches for low temperature applications are useful for refrigerated cells or equipments where the air operational temperature is very low.

These devices, made in special materials, are able to extend the operational temperature range down to -40°C, maintaining mechanical performances intact. To order add the digits "40" following the operating head indication in part number.

For example: CM1E11Z11 ▶ CM1E1140Z11

Limit Switches **CM_E** series

Metal Casing IP66 - 60 mm. width

Electrical connection:

- CM1:** three cable inlets for PG 13,5 Cable Gland
CM2: three cable inlets for 1/2" NPT Cable Gland
CM5: three cable inlets for M20 x 1,5 Cable Gland

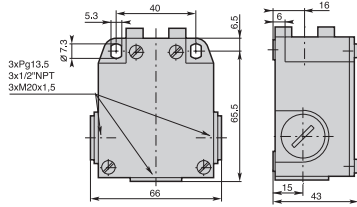

Contact Blocks

Z11 (1NO + 1NC)	CM•E31Z11	CM•E32Z11	CM•E33Z11	CM•E41Z11	CM•E42Z11
X11 (1NO + 1NC)	CM•E31X11	CM•E32X11	CM•E33X11	CM•E41X11	CM•E42X11
Y11 (1NO + 1NC)	CM•E31Y11	CM•E32Y11	CM•E33Y11	CM•E41Y11	CM•E42Y11
W02 (2NC)	CM•E31W02	CM•E32W02	CM•E33W02	CM•E41W02	CM•E42W02
W20 (2NO)	CM•E31W20	CM•E32W20	CM•E33W20	CM•E41W20	CM•E42W20
Z02 (2NC)	CM•E31Z02	CM•E32Z02	CM•E33Z02	CM•E41Z02	CM•E42Z02
X12 (1NO + 2NC)	CM•E31X12	CM•E32X12	CM•E33X12	CM•E41X12	CM•E42X12
X21 (2NO + 1NC)	CM•E31X21	CM•E32X21	CM•E33X21	CM•E41X21	CM•E42X21
W03 (3NC)	CM•E31W03	CM•E32W03	CM•E33W03	CM•E41W03	CM•E42W03
W30 (3NO)	CM•E31W30	CM•E32W30	CM•E33W30	CM•E41W30	CM•E42W30

E3• - One way lever

E31: Ø22 nylon roller E32: Ø22 stainless steel roller

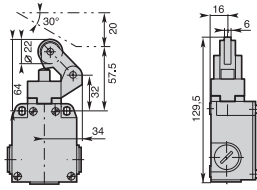

Min. actuating force
Weight

12N (40N ⊖)
305 g

E33 - One way lever Ø22 steel ball bearing

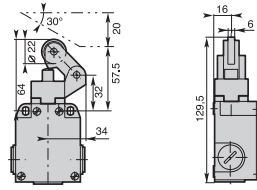

Min. actuating force
Weight

12N (40N ⊖)
305 g

E4• - Ø22 roller lever

E41: Ø22 nylon roller E42: Ø22 stainless steel roller

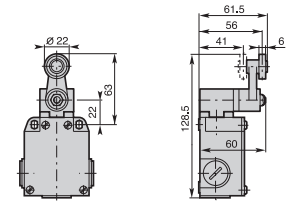

Min. actuating torque
Weight

0,15Nm (0,30Nm ⊖)
305 g

E43 - Ø22 roller lever steel ball bearing

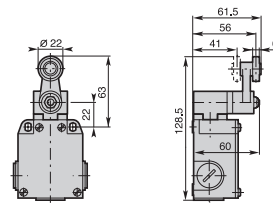

Min. actuating torque
Weight

0,15Nm (0,30Nm ⊖)
305 g

E44 - Ø50 rubber roller lever

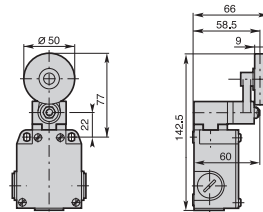

Min. actuating torque
Weight

0,15Nm (0,30Nm ⊖)
315 g

E5• - Adjustable Ø22 roller lever

E51: nylon roller E52: stainless steel roller

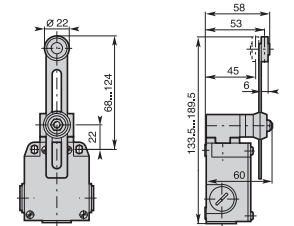
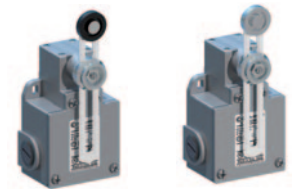

Min. actuating torque
Weight

0,15Nm (0,30Nm ⊖)
325 g

Contact Blocks

Z11 (1NO + 1NC)	CM•E43Z11	CM•E44Z11	CM•E51Z11	CM•E52Z11
X11 (1NO + 1NC)	CM•E43X11	CM•E44X11	CM•E51X11	CM•E52X11
Y11 (1NO + 1NC)	CM•E43Y11	CM•E44Y11	CM•E51Y11	CM•E52Y11
W02 (2NC)	CM•E43W02	CM•E44W02	CM•E51W02	CM•E52W02
W20 (2NO)	CM•E43W20	CM•E44W20	CM•E51W20	CM•E52W20
Z02 (2NC)	CM•E43Z02	CM•E44Z02	CM•E51Z02	CM•E52Z02
X12 (1NO + 2NC)	CM•E43X12	CM•E44X12	CM•E51X12	CM•E52X12
X21 (2NO + 1NC)	CM•E43X21	CM•E44X21	CM•E51X21	CM•E52X21
W03 (3NC)	CM•E43W03	CM•E44W03	CM•E51W03	CM•E52W03
W30 (3NO)	CM•E43W30	CM•E44W30	CM•E51W30	CM•E52W30

Operation diagrams: page 125 - All dimensions are in mm

Limit Switches **CM_E** series

Metal Casing IP66 - 60 mm. width

Electrical connection:

- CM1:** three cable inlets for PG 13,5 Cable Gland
CM2: three cable inlets for 1/2" NPT Cable Gland
CM5: three cable inlets for M20 x 1,5 Cable Gland

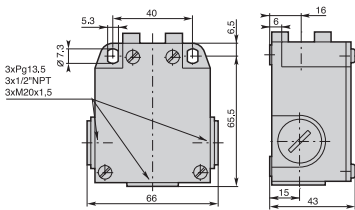

Contact Blocks

Z11 (1NO + 1NC)	CM•E53Z11	CM•E54Z11	CM•E61Z11
X11 (1NO + 1NC)	CM•E53X11	CM•E54X11	CM•E61X11
Y11 (1NO + 1NC)	CM•E53Y11	CM•E54Y11	CM•E61Y11
W02 (2NC)	CM•E53W02	CM•E54W02	CM•E61W02
W20 (2NO)	CM•E53W20	CM•E54W20	CM•E61W20
Z02 (2NC)	CM•E53Z02	CM•E54Z02	CM•E61Z02
X12 (1NO + 2NC)	CM•E53X12	CM•E54X12	CM•E61X12
X21 (2NO + 1NC)	CM•E53X21	CM•E54X21	CM•E61X21
W03 (3NC)	CM•E53W03	CM•E54W03	CM•E61W03
W30 (3NO)	CM•E53W30	CM•E54W30	CM•E61W30

E53 - Adjustable Ø22 roller lever with steel ball bearing

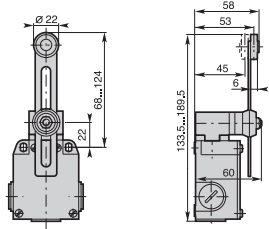
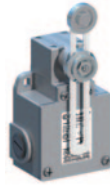

Min. actuating torque 0,15Nm (0,30Nm ⇄)
 Weight 325 g

E54 - Adjustable Ø50 rubber roller lever

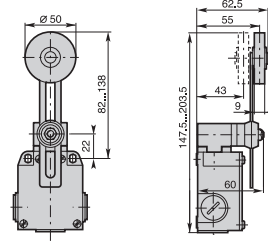

Min. actuating torque 0,15Nm (0,30Nm ⇄)
 Weight 330 g

E61 - Nylon actuator with stainless steel spring

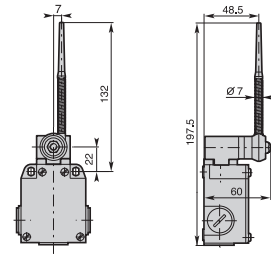

Min. actuating torque 0,15Nm
 Weight 330 g

E62 - Stainless steel spring actuator

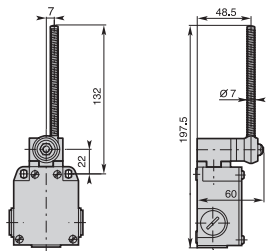

Min. actuating torque 0,15Nm
 Weight 330 g

E7• - Adjustable Ø3 rod lever

E71: stainless steel rod E73: fiberglass rod

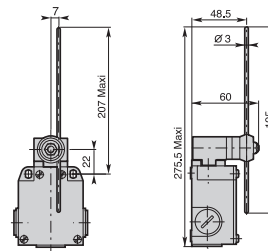

Min. actuating torque 0,15Nm (0,30Nm ⇄)
 Weight 330 g

E72 - Adjustable Ø6 nylon rod lever

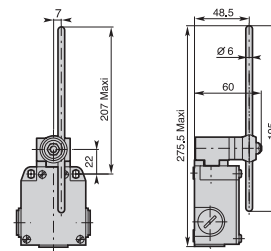

Min. actuating torque 0,15Nm (0,30Nm ⇄)
 Weight 330 g

Contact Blocks

Z11 (1NO + 1NC)	CM•E62Z11	CM•E71Z11	CM•E73Z11	CM•E72Z11
X11 (1NO + 1NC)	CM•E62X11	CM•E71X11	CM•E73X11	CM•E72X11
Y11 (1NO + 1NC)	CM•E62Y11	CM•E71Y11	CM•E73Y11	CM•E72Y11
W02 (2NC)	CM•E62W02	CM•E71W02	CM•E73W02	CM•E72W02
W20 (2NO)	CM•E62W20	CM•E71W20	CM•E73W20	CM•E72W20
Z02 (2NC)	CM•E62Z02	CM•E71Z02	CM•E73Z02	CM•E72Z02
X12 (1NO + 2NC)	CM•E62X12	CM•E71X12	CM•E73X12	CM•E72X12
X21 (2NO + 1NC)	CM•E62X21	CM•E71X21	CM•E73X21	CM•E72X21
W03 (3NC)	CM•E62W03	CM•E71W03	CM•E73W03	CM•E72W03
W30 (3NO)	CM•E62W30	CM•E71W30	CM•E73W30	CM•E72W30

Operation diagrams: page 125 - All dimensions are in mm

Limit Switches **CM_E** series

Metal Casing IP66 - 60 mm. width

Electrical connection:

- CM1:** three cable inlets for PG 13,5 Cable Gland
CM2: three cable inlets for 1/2" NPT Cable Gland
CM5: three cable inlets for M20 x 1,5 Cable Gland

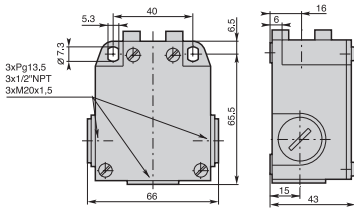

Contact Blocks

Z11 (1NO + 1NC)	CM•E74Z11	CM•E75Z11	CM•E91Z11
X11 (1NO + 1NC)	CM•E74X11	CM•E75X11	CM•E91X11
Y11 (1NO + 1NC)	CM•E74Y11	CM•E75Y11	CM•E91Y11
W02 (2NC)	CM•E74W02	CM•E75W02	CM•E91W02
W20 (2NO)	CM•E74W20	CM•E75W20	CM•E91W20
Z02 (2NC)	CM•E74Z02	CM•E75Z02	CM•E91Z02
X12 (1NO + 2NC)	CM•E74X12	CM•E75X12	CM•E91X12
X21 (2NO + 1NC)	CM•E74X21	CM•E75X21	CM•E91X21
W03 (3NC)	CM•E74W03	CM•E75W03	CM•E91W03
W30 (3NO)	CM•E74W30	CM•E75W30	CM•E91W30

E74 - Adjustable Ø6 fiberglass rod lever

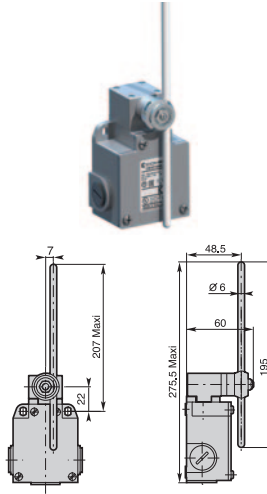

Min. actuating torque **0,15Nm (0,30Nm ⊖)**
 Weight **330 g**

E75 - Adjustable 3x3 square steel rod lever

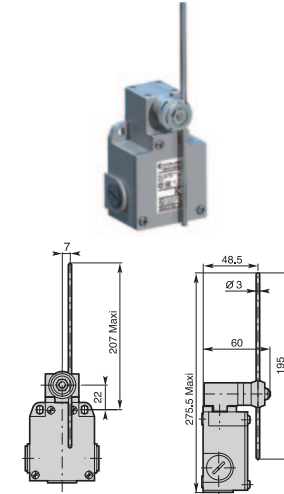

Min. actuating torque **0,15Nm (0,30Nm ⊖)**
 Weight **330 g**

E91 - Stainless steel spring multidirectional actuator

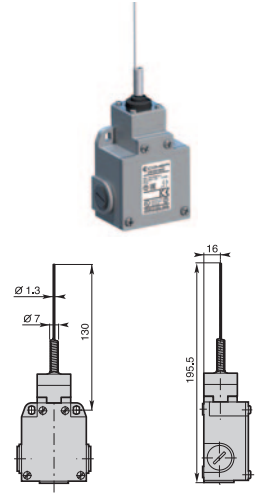

Min. actuating torque **0,18Nm**
 Weight **265 g**

E92 - Multidirectional nylon actuator with stainless steel spring

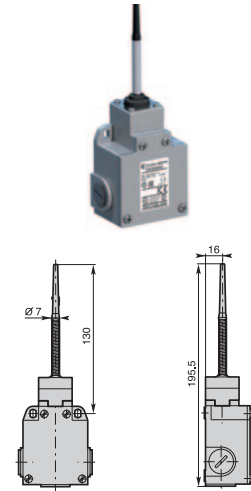

Min. actuating torque **0,18Nm**
 Weight **265 g**

E93 - Stainless steel spring multidirectional actuator

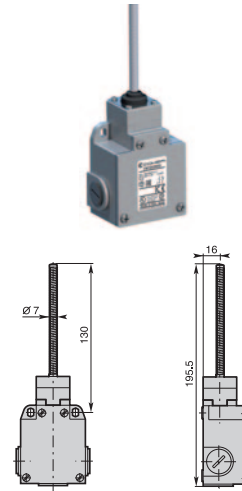

Min. actuating torque **0,18Nm**
 Weight **270 g**

E99 - Pull action with ring

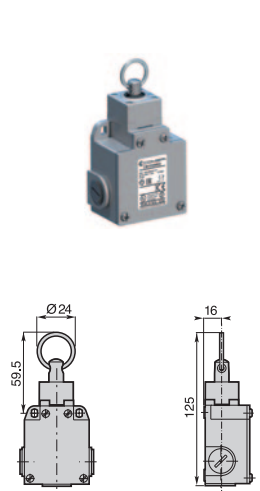

Min. actuating force **25N**
 Weight **270 g**

Contact Blocks

Z11 (1NO + 1NC)	CM•E92Z11	CM•E93Z11	CM•E99Z11A
X11 (1NO + 1NC)	CM•E92X11	CM•E93X11	CM•E99X11A
Y11 (1NO + 1NC)	CM•E92Y11	CM•E93Y11	CM•E99Y11A
W02 (2NC)	CM•E92W02	CM•E93W02	CM•E99W02A
W20 (2NO)	CM•E92W20	CM•E93W20	CM•E99W20A
Z02 (2NC)	CM•E92Z02	CM•E93Z02	
X12 (1NO + 2NC)	CM•E92X12	CM•E93X12	CM•E99X12A
X21 (2NO + 1NC)	CM•E92X21	CM•E93X21	CM•E99X21A
W03 (3NC)	CM•E92W03	CM•E93W03	CM•E99W03A
W30 (3NO)	CM•E92W30	CM•E93W30	CM•E99W30A

Operation diagrams: page 125 - All dimensions are in mm

Limit Switches **CM_P** series

Metal Casing IP66 - 60 mm. width

Electrical connection:

- CM1:** three cable inlets for PG 13,5 Cable Gland
CM2: three cable inlets for 1/2" NPT Cable Gland
CM5: three cable inlets for M20 x 1,5 Cable Gland

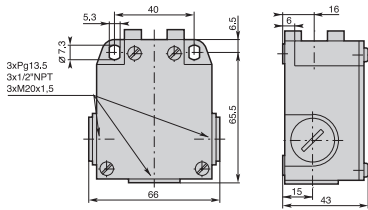

P11 - Plain plunger

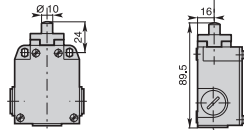

Min. actuating force
Weight **30N (45N ⊖)**
245 g

P92 - Multidirectional nylon actuator with stainless steel spring

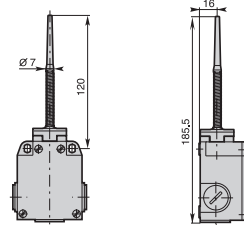

Min. actuating torque
Weight **0,18Nm**
245 g

P93 - Stainless steel spring multidirectional actuator

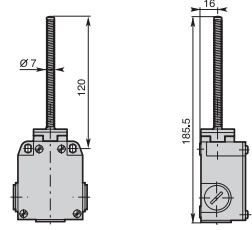

Min. actuating torque
Weight **0,18Nm**
250 g

Contact Blocks

Z11 (1NO + 1NC)	CM•P11Z11	CM•P92Z11	CM•P93Z11
X11 (1NO + 1NC)	CM•P11X11	CM•P92X11	CM•P93X11
Y11 (1NO + 1NC)	CM•P11Y11	CM•P92Y11	CM•P93Y11
W02 (2NC)	CM•P11W02	CM•P92W02	CM•P93W02
W20 (2NO)	CM•P11W20	CM•P92W20	CM•P93W20
Z02 (2NC)	CM•P11Z02	CM•P92Z02	CM•P93Z02
X12 (1NO + 2NC)	CM•P11X12	CM•P92X12	CM•P93X12
X21 (2NO + 1NC)	CM•P11X21	CM•P92X21	CM•P93X21
W03 (3NC)	CM•P11W03	CM•P92W03	CM•P93W03
W30 (3NO)	CM•P11W30	CM•P92W30	CM•P93W30

Limit Switches **CM_M** series

Metal Casing IP66 - 60 mm. width

Electrical connection:

CM1: three cable inlets for PG 13,5 Cable Gland
CM2: three cable inlets for 1/2" NPT Cable Gland
CM5: three cable inlets for M20 x 1,5 Cable Gland

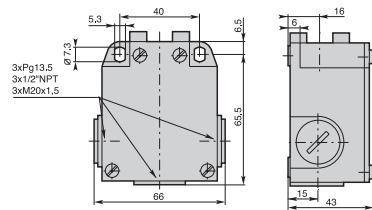

M13 - Steel roller plunger

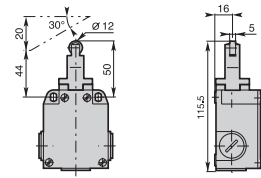

Min. actuating force **22N (40N ⊖)**
 Weight **290 g**

M14 - Plain steel plunger with dust protection cup

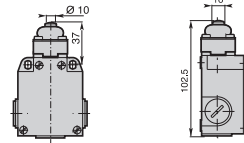

Min. actuating force **30N (45N ⊖)**
 Weight **280 g**

M19 - Steel roller plunger with dust protection cup

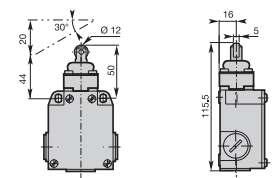

Min. actuating force **22N (40N ⊖)**
 Weight **290 g**

Contact Blocks

Z11 (1NO + 1NC)	CM•M13Z11	CM•M14Z11	CM•M19Z11
X11 (1NO + 1NC)	CM•M13X11	CM•M14X11	CM•M19X11
Y11 (1NO + 1NC)	CM•M13Y11	CM•M14Y11	CM•M19Y11
W02 (2NC)	CM•M13W02	CM•M14W02	CM•M19W02
W20 (2NO)	CM•M13W20	CM•M14W20	CM•M19W20
Z02 (2NC)	CM•M13Z02	CM•M14Z02	CM•M19Z02
X12 (1NO + 2NC)	CM•M13X12	CM•M14X12	CM•M19X12
X21 (2NO + 1NC)	CM•M13X21	CM•M14X21	CM•M19X21
W03 (3NC)	CM•M13W03	CM•M14W03	CM•M19W03
W30 (3NO)	CM•M13W30	CM•M14W30	CM•M19W30

M41 - Ø22 nylon roller lever

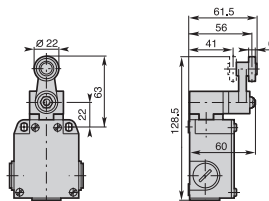

Min. actuating torque **0,15Nm (0,30Nm ⊖)**
 Weight **325 g**

M42 - Ø22 stainless steel roller lever

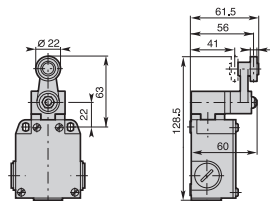
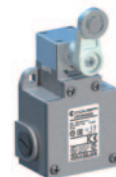

Min. actuating torque **0,15Nm (0,30Nm ⊖)**
 Weight **325 g**

M43 - Ø22 roller lever with steel ball bearing

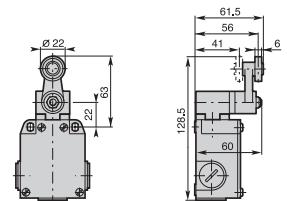

Min. actuating torque **0,15Nm (0,30Nm ⊖)**
 Weight **325 g**

Contact Blocks

Z11 (1NO + 1NC)	CM•M41Z11	CM•M42Z11	CM•M43Z11
X11 (1NO + 1NC)	CM•M41X11	CM•M42X11	CM•M43X11
Y11 (1NO + 1NC)	CM•M41Y11	CM•M42Y11	CM•M43Y11
W02 (2NC)	CM•M41W02	CM•M42W02	CM•M43W02
W20 (2NO)	CM•M41W20	CM•M42W20	CM•M43W20
Z02 (2NC)	CM•M41Z02	CM•M42Z02	CM•M43Z02
X12 (1NO + 2NC)	CM•M41X12	CM•M42X12	CM•M43X12
X21 (2NO + 1NC)	CM•M41X21	CM•M42X21	CM•M43X21
W03 (3NC)	CM•M41W03	CM•M42W03	CM•M43W03
W30 (3NO)	CM•M41W30	CM•M42W30	CM•M43W30

Operation diagrams: page 125 - All dimensions are in mm

Limit Switches **CM_M** series

Metal Casing IP66 - 60 mm. width

Electrical connection:

- CM1:** three cable inlets for PG 13,5 Cable Gland
CM2: three cable inlets for 1/2" NPT Cable Gland
CM5: three cable inlets for M20 x 1,5 Cable Gland

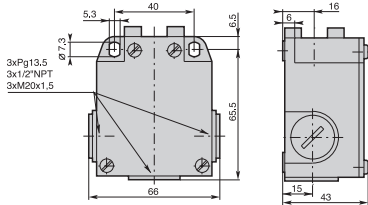

M44 - Ø50 rubber roller lever

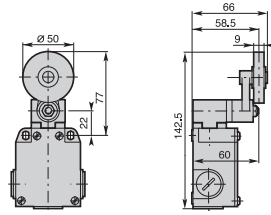
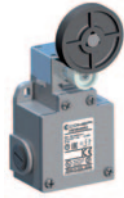

Min. actuating torque 0,15Nm (0,30Nm ⊖)
 Weight 335 g

M51 - Adjustable Ø22 nylon roller lever

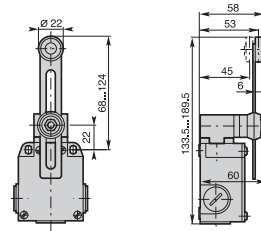
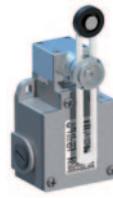

Min. actuating torque 0,15Nm (0,30Nm ⊖)
 Weight 345 g

M52 - Adjustable Ø22 stainless steel roller lever

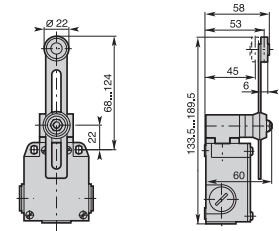

Min. actuating torque 0,15Nm (0,30Nm ⊖)
 Weight 345 g

Contact Blocks

Z11 (1NO + 1NC)	CM•M44Z11	CM•M51Z11	CM•M52Z11
X11 (1NO + 1NC)	CM•M44X11	CM•M51X11	CM•M52X11
Y11 (1NO + 1NC)	CM•M44Y11	CM•M51Y11	CM•M52Y11
W02 (2NC)	CM•M44W02	CM•M51W02	CM•M52W02
W20 (2NO)	CM•M44W20	CM•M51W20	CM•M52W20
Z02 (2NC)	CM•M44Z02	CM•M51Z02	CM•M52Z02
X12 (1NO + 2NC)	CM•M44X12	CM•M51X12	CM•M52X12
X21 (2NO + 1NC)	CM•M44X21	CM•M51X21	CM•M52X21
W03 (3NC)	CM•M44W03	CM•M51W03	CM•M52W03
W30 (3NO)	CM•M44W30	CM•M51W30	CM•M52W30

M53 - Adjustable Ø22 roller lever with steel ball bearing

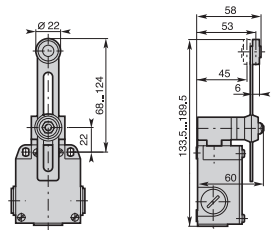
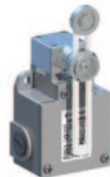

Min. actuating torque 0,15Nm (0,30Nm ⊖)
 Weight 345 g

M54 - Adjustable Ø50 rubber roller lever

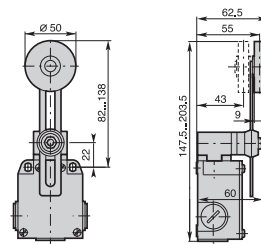

Min. actuating torque 0,15Nm (0,30Nm ⊖)
 Weight 350 g

M61 - Nylon actuator with stainless steel spring

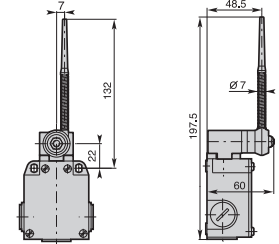

Min. actuating torque 0,15Nm
 Weight 350 g

Contact Blocks

Z11 (1NO + 1NC)	CM•M53Z11	CM•M54Z11	CM•M61Z11
X11 (1NO + 1NC)	CM•M53X11	CM•M54X11	CM•M61X11
Y11 (1NO + 1NC)	CM•M53Y11	CM•M54Y11	CM•M61Y11
W02 (2NC)	CM•M53W02	CM•M54W02	CM•M61W02
W20 (2NO)	CM•M53W20	CM•M54W20	CM•M61W20
Z02 (2NC)	CM•M53Z02	CM•M54Z02	CM•M61Z02
X12 (1NO + 2NC)	CM•M53X12	CM•M54X12	CM•M61X12
X21 (2NO + 1NC)	CM•M53X21	CM•M54X21	CM•M61X21
W03 (3NC)	CM•M53W03	CM•M54W03	CM•M61W03
W30 (3NO)	CM•M53W30	CM•M54W30	CM•M61W30

Operation diagrams: page 125 - All dimensions are in mm

Limit Switches **CM_M** series

Metal Casing IP66 - 60 mm. width

Electrical connection:

CM1: three cable inlets for PG 13,5 Cable Gland

CM2: three cable inlets for 1/2" NPT Cable Gland

CM5: three cable inlets for M20 x 1,5 Cable Gland

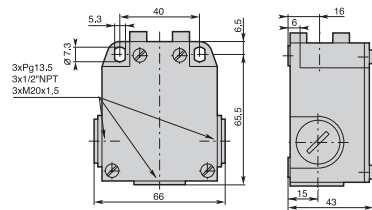

M62 - Stainless steel spring actuator

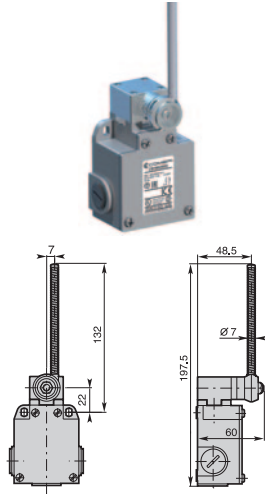

Min. actuating torque **0,15Nm**
Weight **350 g**

M71 - Adjustable Ø3 stainless steel rod lever

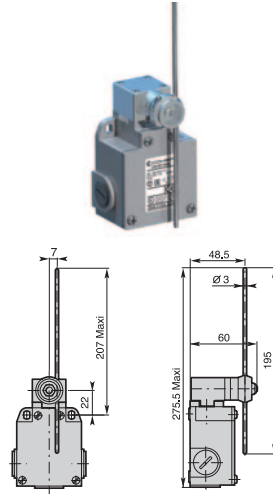

Min. actuating torque **0,15Nm (0,30Nm ⊖)**
Weight **350 g**

M72 - Adjustable Ø6 nylon rod lever

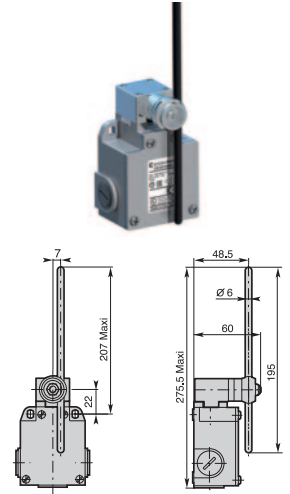

Min. actuating torque **0,15Nm (0,30Nm ⊖)**
Weight **350 g**

Contact Blocks

Z11 (1NO + 1NC)	CM•M62Z11	CM•M71Z11	CM•M72Z11
X11 (1NO + 1NC)	CM•M62X11	CM•M71X11	CM•M72X11
Y11 (1NO + 1NC)	CM•M62Y11	CM•M71Y11	CM•M72Y11
W02 (2NC)	CM•M62W02	CM•M71W02	CM•M72W02
W20 (2NO)	CM•M62W20	CM•M71W20	CM•M72W20
Z02 (2NC)	CM•M62Z02	CM•M71Z02	CM•M72Z02
X12 (1NO + 2NC)	CM•M62X12	CM•M71X12	CM•M72X12
X21 (2NO + 1NC)	CM•M62X21	CM•M71X21	CM•M72X21
W03 (3NC)	CM•M62W03	CM•M71W03	CM•M72W03
W30 (3NO)	CM•M62W30	CM•M71W30	CM•M72W30

M73 - Adjustable Ø3 fiberglass rod lever

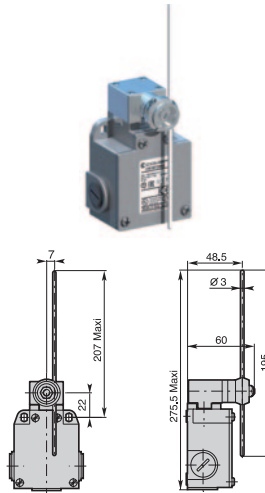

Min. actuating torque **0,15Nm (0,30Nm ⊖)**
Weight **350 g**

M74 - Adjustable Ø6 fiberglass rod lever

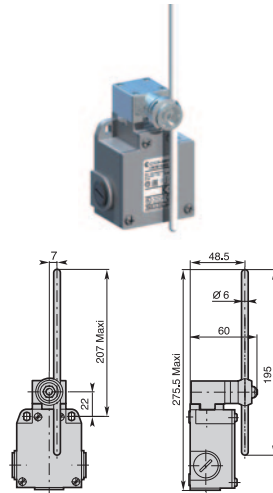

Min. actuating torque **0,15Nm (0,30Nm ⊖)**
Weight **350 g**

M75 - Adjustable 3x3 square steel rod lever

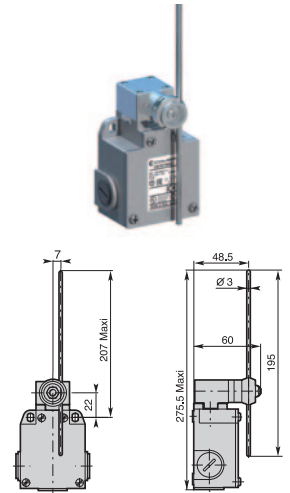

Min. actuating torque **0,15Nm (0,30Nm ⊖)**
Weight **350 g**

Contact Blocks

Z11 (1NO + 1NC)	CM•M73Z11	CM•M74Z11	CM•M75Z11
X11 (1NO + 1NC)	CM•M73X11	CM•M74X11	CM•M75X11
Y11 (1NO + 1NC)	CM•M73Y11	CM•M74Y11	CM•M75Y11
W02 (2NC)	CM•M73W02	CM•M74W02	CM•M75W02
W20 (2NO)	CM•M73W20	CM•M74W20	CM•M75W20
Z02 (2NC)	CM•M73Z02	CM•M74Z02	CM•M75Z02
X12 (1NO + 2NC)	CM•M73X12	CM•M74X12	CM•M75X12
X21 (2NO + 1NC)	CM•M73X21	CM•M74X21	CM•M75X21
W03 (3NC)	CM•M73W03	CM•M74W03	CM•M75W03
W30 (3NO)	CM•M73W30	CM•M74W30	CM•M75W30

Operation diagrams: page 125 - All dimensions are in mm

Limit Switches EP series

Summary

APPROVALS: UL 508 / CSA C22-2 N. 14 / IEC 60947-5-1



CB-SCHEME certification according to IEC 60947-5-1

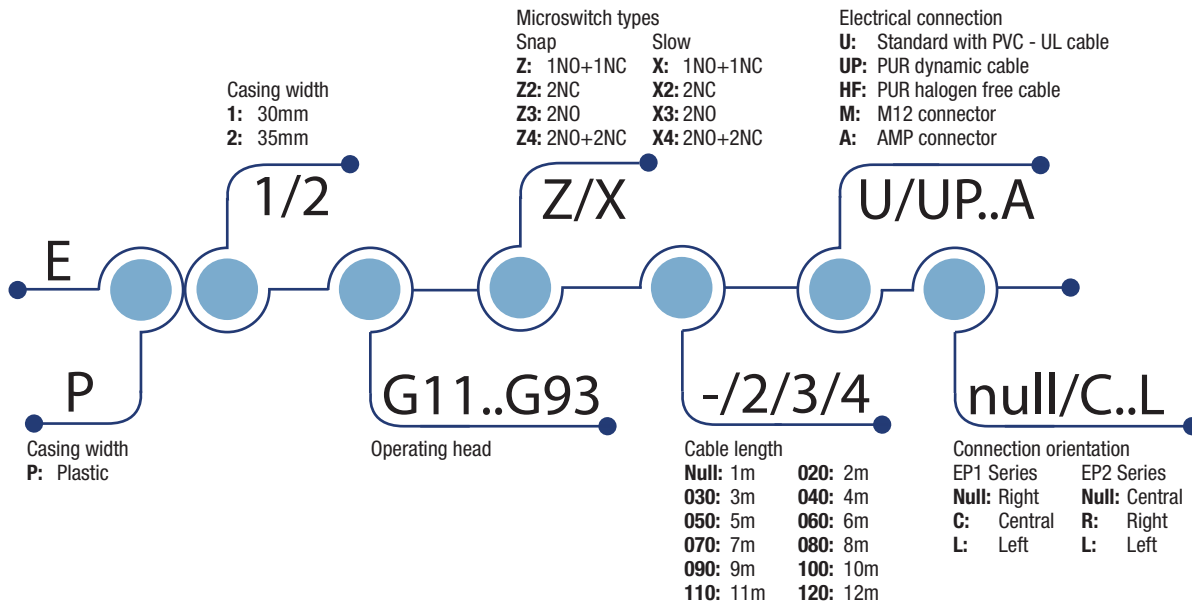

HOW IS IT MADE?

01 A variety of actuators

- Plain plunger
- Roller plunger
- Roller lever, adjustable or not, etc.

02 Wide range of heads

- Assembled using 2 x Ø3 screws or 2 plug

03 Casing:

- 30 or 35 mm. width

04 Mounting screws

- 2 x M4 screws on top part

05 Epoxy resin for IP67 protection degree

06 Contact Block

- Positive opening operation
- Snap action or slow action
- Electrically separated contacts

07 Connecting terminals

- Cable: PVC 4 x 0,75 mm²
- Special cables: Halogen Free or Dynamic PUR
- M12 connector
- AMP connector

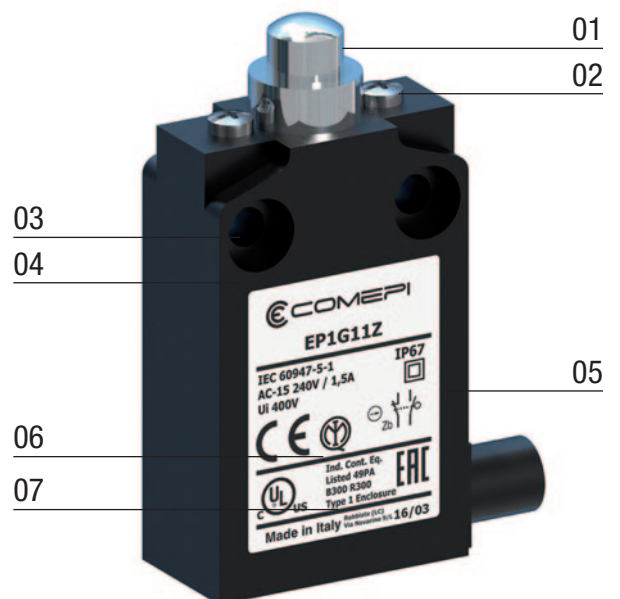

Limit Switches EP series

Description

APPLICATIONS

Easy to use, electromechanical limit switches offer specific qualities:

- Visible operation.
- Able to switch strong currents (up to 10 A conventional thermal current).
- Electrically separated contacts.
- Precise operating points (consistency).
- Immune to electromagnetic disturbances.

They are purpose-built detection devices thanks to these characteristics:

- Presence/absence.
- Positioning and travel limit.
- Objects passing/counting.

DESCRIPTION

These limit switches, made in thermoplastic material, sealed with epoxy resin at the base on the box, offer a degree of protection IP67.

The casing come in 2 dimensions: – EP1... 30 mm. width – EP2... 35 mm. width

They comply with the requirements of European Directives (Low Voltage and RoHS) and are conform to European and International Standards.

The CE declaration of these products are available in the download section of website www.comepi.it or by writing to the following email address: tecnico@comepi.it
DDC02 - Limit Switches.

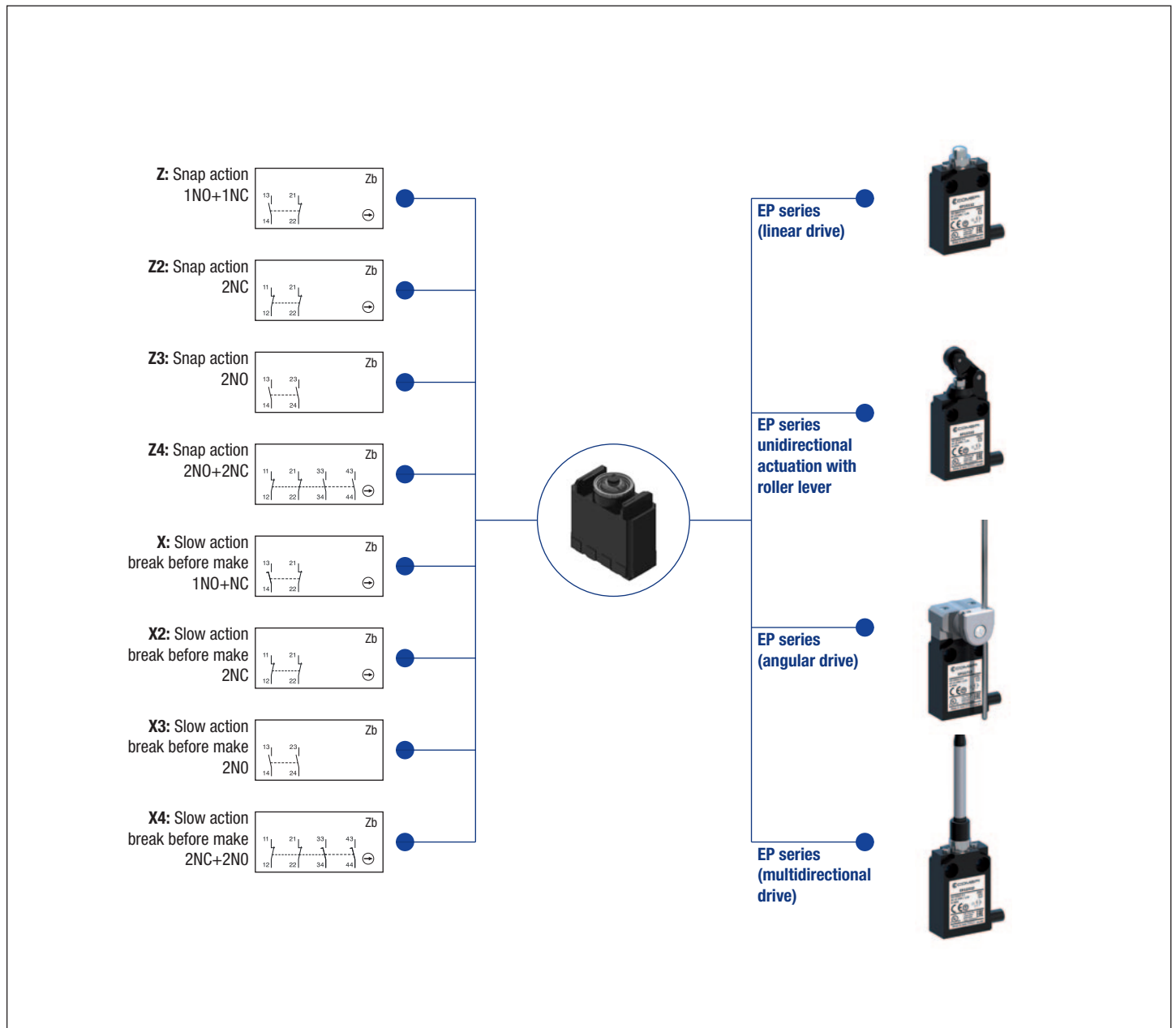

Limit Switches EP series

Technical Data

	EP Series	
Standards	IEC 60947-5-1 EN 60947-5-1	
Air temperature near the device		
– during operation	°C	– 25 ... + 70
– for storage	°C	– 40 ... + 70
Mounting positions	All positions are authorised	
Protection against electrical shocks (acc. to IEC 61140)	Class II	
Degree of protection (according to IEC 60529 and EN 60529)	IP 67	
Degree of protection (according to UL50)	Type 1 enclosure (“indoor use only”)	
Switching frequency	Cycles/h	3600
Mechanical durability	10 millions of operations	

Electrical data - Electrical connections

Code	EP_U	EP_UP	EP_HF	EP_M	EP_A
Connection type	4xAWG18 0,75mm ² PVC Style 2517	4xAWG18 dynamic 0,75mm ² PUR style 20668	4xAWG18 0,75mm ² Halogen Free PUR style 20668	M12 connector integrated 4x0,25mm ²	AMP connector integrated
Min. bend radius	49mm	49mm	49mm	–	–
Rated insulation voltage U _i	400V	300V	300V	250V	250V
Pollution degree	3	3	3	3	3
Rated impulse withstand voltage U _{imp}	4kV	4kV	4kV	2.5kV	2.5kV
Conventional free air thermal current I _{th}	10A	10A	10A	4A	4A
Short circuit current I _{cc}	1kA	1kA	1kA	1kA	1kA
Short-circuit protection	10A 500V type gG	10A 500V type gG	10A 500V type gG	4A 500V type gG	4A 500V type gG
AC15	24V 120V 240V	10A 6A 3A	10A 6A 3A	10A 6A 3A	4A 4A 3A
DC13	24V 125V 250V	2.8A 0.55A 0.27A	2.8A 0.55A 0.27A	2.8A 0.55A 0.27A	2.8A 0.55A 0.27A
Approvals	cULus EAC CCC UKCA	cULus EAC CCC UKCA	cULus EAC CCC UKCA	cULus IMQ EAC CCC UKCA	EAC UKCA

Code	X2/X3	X4	Z2/Z3	Z4
Connection type	4xAWG18 0,75mm ² PVC Style 2517	8xAWG22 0,5mm ² PVC Style 2517	4xAWG18 0,75mm ² PVC Style 2517	8xAWG22 0,5mm ² PVC Style 2517
Min. bend radius	49mm	49mm	49mm	49mm
Rated insulation voltage U _i	250V	250V	250V	250V
Pollution degree	3	3	3	3
Rated impulse withstand voltage U _{imp}	2.5kV	2.5kV	2.5kV	2.5kV
Conventional free air thermal current I _{th}	4A	4A	4A	4A
Short-circuit protection	4A 500V type gG	4A 500V type gG	4A 500V type gG	4A 500V Type gG
AC15	24V 240V	4A 3A	4A 3A	4A 3A
DC13	24V 250V	2A 0.4A	2A 0.4A	2A /
Approvals	cULus EAC CCC UKCA	cULus EAC CCC UKCA	cULus EAC CCC UKCA	cULus EAC CCC UKCA

Limit Switches **EP series**

Wiring Diagram

Serie EP_U / EP_UP / EP_HF

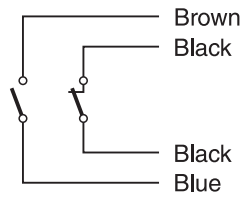

Serie EP_M

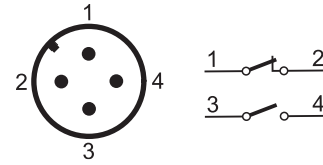

Serie EP_A

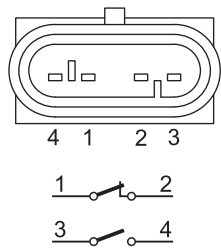

Serie EP_X2 / Z2

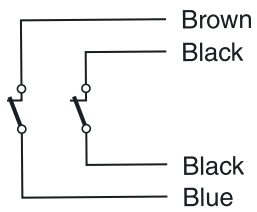

Serie EP_X3 / Z3

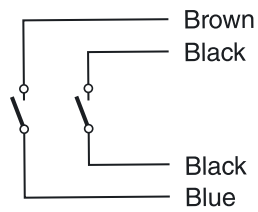

Serie EP_X4 / Z4

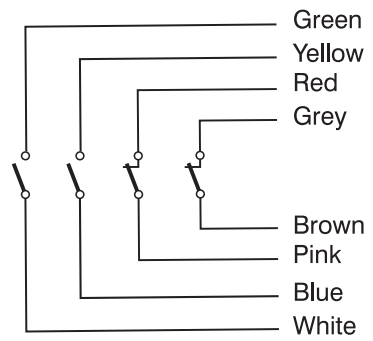

Limit Switches **EP series**

Technical Data



Standard PVC UL cable

All models can be supplied with a standard PVC UL cable.
To order, keep the suffix "U" of the standard
Example: EP1G11ZU



Dynamic PUR cable

A greater flexibility characterize these models compared to the UL standard, while maintaining the same features and the same electrical ratings. Moreover, the external sheath, polyurethane made, guarantees more resistance in stern working environments.
To order add the digit "P" at the end of the UL standard part number.
Example: EP1G11ZU ➔ EP1G11ZUP



Halogen free PUR cable

The absence of halogens guarantees less fumes and toxic gases released in case of fire. Moreover, the external sheath, polyurethane made, guarantees more resistance in stern working environments.
To order add the digit "HF" at the end of the part number.
Example: EP1G11ZHF



M12 connector

All the models can be supplied with M12 connector.
To order replace the "U" suffix of the standard UL version with suffix "M".
Example: EP1G11ZU ➔ EP1G11ZM



AMP connector

All the models can be supplied with AMP connector.
To order replace the "U" suffix of the standard UL version with suffix "A".
Example: EP1G11ZU ➔ EP1G11ZA

Cable connection orientation



Cable connection orientation

For EP1 Series, standard version is supplied with right electrical connection exit.
Available version with left or central exit: add respectively digit "L" or "C" at the end of the complete part number.
Example: EP1G11ZU ➔ EP1G11ZUL



For EP2 Series, standard version is supplied with central electrical connection exit.
Available version with left or right exit: add respectively digit "L" or "R" at the end of the complete part number.
Example: EP2G11ZU ➔ EP2G11ZUR

Limit Switches EP series

Technical Data

Technical data approved by IMQ

Standards		Devices conform with international IEC 60947-5-1 and European EN 60947-5-1 standards
Degree of protection		IP 67
Rated insulation voltage U_i		400 V (degree of pollution 3) (250V for M12 connector)
Rated impulse withstand voltage U_{imp}		4 kV (2.5 kV for M12 connector)
Conventional free air thermal current I_{th}		10 A (4A for M12 connector)
Short-circuit protection - gG (gl) type fuses		10 A (4A for M12 connector)
Rated operational current		
I_e / AC-15	24 V - 50/60 Hz	10 A (except M12 connector)
	400 V - 50/60 Hz	3 A (except M12 connector)
I_e / DC-13	24 V - d.c.	2.8 A
	250 V - d.c.	0.27 A

Technical data approved by UL

Standards		Devices conform with UL 508
Degree of protection:		
EP Series	Type 1 enclosure ("indoor use only")	
EM Series	Type 4 - 4X - 6 enclosure ("outdoor use raintight - watertight - corrosion resistant")	
Utilization categories:		
Cable versions	B300 - R300 (C300-R300)	
M12 connector versions	Class-2	

For the complete list of approved products, contact our technical department

IMPLEMENTATION

Operating head orientation

The head can be rotated each 180° (90° for special version with fixing pins).

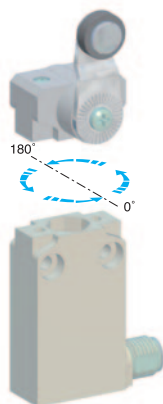

Lever adjustment

The lever of the angular actuators can be adjusted every 10° and round turned in order to obtain the maximum flexibility on the working plan. Recommended tightening torque 0,5 Nm (max 0,8 Nm).

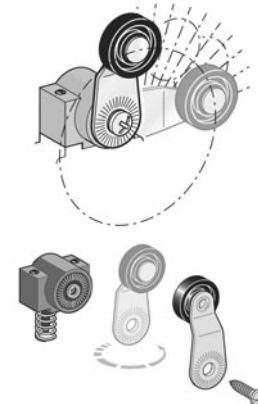

Special Versions



Head installation

Two different solutions are available to fix the head to the body of the switch. The standard solution is made by means of two $\varnothing 3$ screws. On some models it is possible to order the switch with head fixation by means of two pins. This solution will allow a greater resistance to vibrations when needed and it makes it possible for the end user to install the limit switch directly on a panel as shown in the picture on the side.

Please contact our technical department for further details.

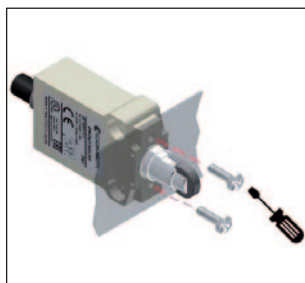

Limit Switches **EP1G series**

Pre-wired - Plastic Casing IP67 - 30 mm. width

Electrical connection:

Pre-Wired

Cable: PVC 4 x 0,75 mm²

Length: 1 m.

Pre-wired

See page 78 for all the available connection variants

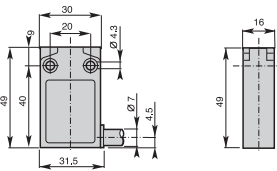

G11 - Plain plunger

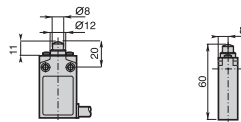

Min. actuating force
Weight

15N (30N ⊖)
125 g

G1• - Roller plunger

G12: metal roller G13: nylon roller

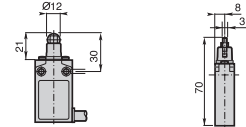

Min. actuating force
Weight

10N (30N ⊖)
130 g

G1• - Cross roller plunger

G14: metal roller G15: nylon roller

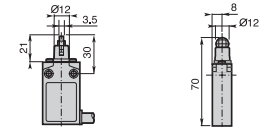

Min. actuating force
Weight

10N (30N ⊖)
130 g

Contact Blocks

Z	Snap action contacts (1NO + 1NC)	EP1G11ZU	EP1G12ZU	EP1G13ZU	EP1G14ZU	EP1G15ZU
Z2	Snap action contacts (2NC)	EP1G11Z2U	EP1G12Z2U	EP1G13Z2U	EP1G14Z2U	EP1G15Z2U
Z3	Snap action contacts (2NO)	EP1G11Z3U	EP1G12Z3U	EP1G13Z3U	EP1G14Z3U	EP1G15Z3U
Z4	Snap action contacts (2NC + 2NO)	EP1G11Z4U	EP1G12Z4U	EP1G13Z4U	EP1G14Z4U	EP1G15Z4U
X	Non overlapping slow action contacts (1NO + 1NC)	EP1G11XU	EP1G12XU	EP1G13XU	EP1G14XU	EP1G15XU
X2	Slow action contacts (2NC)	EP1G11X2U	EP1G12X2U	EP1G13X2U	EP1G14X2U	EP1G15X2U
X3	Slow action contacts (2NO)	EP1G11X3U	EP1G12X3U	EP1G13X3U	EP1G14X3U	EP1G15X3U
X4	Non overlapping slow action contacts (2NO + 2NC)	EP1G11X4U	EP1G12X4U	EP1G13X4U	EP1G14X4U	EP1G15X4U

G16 - Plain plunger with dust protection cup

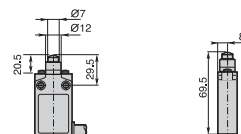

Min. actuating force
Weight

15N (30N ⊖)
130 g

G21 - Plain plunger with fixing nuts

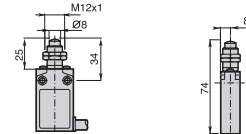

Min. actuating force
Weight

15N (30N ⊖)
140 g

G2• - Roller plunger with fixing nuts

G22: metal roller G23: nylon roller

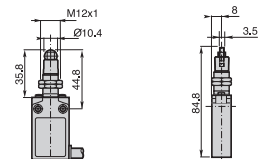

Min. actuating force
Weight

10N (30N ⊖)
145 g

Contact Blocks

Z	Snap action contacts (1NO + 1NC)	EP1G16ZU	EP1G21ZU	EP1G22ZU	EP1G23ZU
Z2	Snap action contacts (2NC)	EP1G16Z2U	EP1G21Z2U	EP1G22Z2U	EP1G23Z2U
Z3	Snap action contacts (2NO)	EP1G16Z3U	EP1G21Z3U	EP1G22Z3U	EP1G23Z3U
Z4	Snap action contacts (2NC + 2NO)	EP1G16Z4U	EP1G21Z4U	EP1G22Z4U	EP1G23Z4U
X	Non overlapping slow action contacts (1NO + 1NC)	EP1G16XU	EP1G21XU	EP1G22XU	EP1G23XU
X2	Slow action contacts (2NC)	EP1G16X2U	EP1G21X2U	EP1G22X2U	EP1G23X2U
X3	Slow action contacts (2NO)	EP1G16X3U	EP1G21X3U	EP1G22X3U	EP1G23X3U
X4	Non overlapping slow action contacts (2NO + 2NC)	EP1G16X4U	EP1G21X4U	EP1G22X4U	EP1G23X4U

Operation diagrams: page 126 - All dimensions are in mm

Limit Switches **EP1G series**

Pre-wired - Plastic Casing IP67 - 30 mm. width

Electrical connection:

Pre-Wired

Cable: PVC 4 x 0,75 mm²

Length: 1 m.

Pre-wired

See page 78 for all the available connection variants

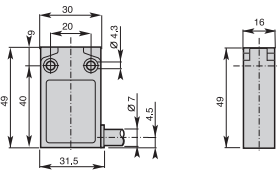

G2• - Cross roller plunger with fixing nuts

G24: metal roller G25: nylon roller

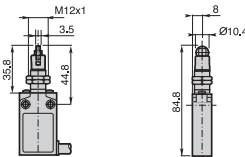

Min. actuating force
Weight

10N (30N ⇄)
145 g

G31 - Nylon roller lever

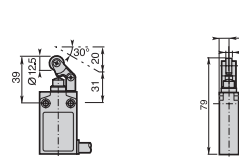

Min. actuating force
Weight

7N (24N ⇄)
130 g

G32 - Nylon roller lever

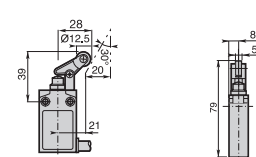

Min. actuating force
Weight

7N (24N ⇄)
130 g

Contact Blocks

Z Snap action contacts (1NO + 1NC)	EP1G24ZU	EP1G25ZU	EP1G31ZU	EP1G32ZU
Z2 Snap action contacts (2NC)	EP1G24Z2U	EP1G25Z2U	EP1G31Z2U	EP1G32Z2U
Z3 Snap action contacts (2NO)	EP1G24Z3U	EP1G25Z3U	EP1G31Z3U	EP1G32Z3U
Z4 Snap action contacts (2NC + 2NO)	EP1G24Z4U	EP1G25Z4U	EP1G31Z4U	EP1G32Z4U
X Non overlapping slow action contacts (1NO + 1NC)	EP1G24XU	EP1G25XU	EP1G31XU	EP1G32XU
X2 Slow action contacts (2NC)	EP1G24X2U	EP1G25X2U	EP1G31X2U	EP1G32X2U
X3 Slow action contacts (2NO)	EP1G24X3U	EP1G25X3U	EP1G31X3U	EP1G32X3U
X4 Non overlapping slow action contacts (2NO + 2NC)	EP1G24X4U	EP1G25X4U	EP1G31X4U	EP1G32X4U

G38 - Adjustable nylon roller lever

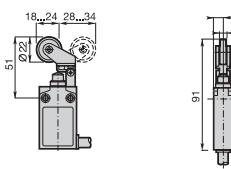

Min. actuating force
Weight

7N (24N ⇄)
135 g

G41 - Ø14 nylon roller lever

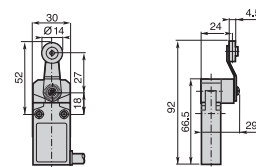

Min. actuating torque
Weight

0,08Nm (0,28Nm ⇄)
175 g

G42 - Ø14 metal roller lever

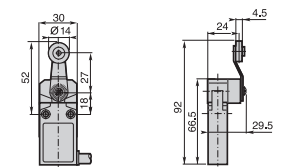

Min. actuating torque
Weight

0,08Nm (0,28Nm ⇄)
175 g

Contact Blocks

Z Snap action contacts (1NO + 1NC)	EP1G38ZU	EP1G41ZU	EP1G42ZU
Z2 Snap action contacts (2NC)	EP1G38Z2U	EP1G41Z2U	EP1G42Z2U
Z3 Snap action contacts (2NO)	EP1G38Z3U	EP1G41Z3U	EP1G42Z3U
Z4 Snap action contacts (2NC + 2NO)	EP1G38Z4U	EP1G41Z4U	EP1G42Z4U
X Non overlapping slow action contacts (1NO + 1NC)	EP1G38XU	EP1G41XU	EP1G42XU
X2 Slow action contacts (2NC)	EP1G38X2U	EP1G41X2U	EP1G42X2U
X3 Slow action contacts (2NO)	EP1G38X3U	EP1G41X3U	EP1G42X3U
X4 Non overlapping slow action contacts (2NO + 2NC)	EP1G38X4U	EP1G41X4U	EP1G42X4U

Operation diagrams: page 126 - All dimensions are in mm

Limit Switches **EP1G series**

Pre-wired - Plastic Casing IP67 - 30 mm. width

Electrical connection:

Pre-Wired

Cable: PVC 4 x 0,75 mm²

Length: 1 m.

Pre-wired

See page 78 for all the available connection variants

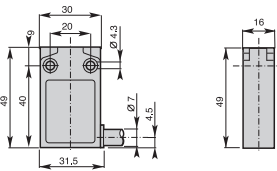

G43 - Ø14 roller lever with ball bearing

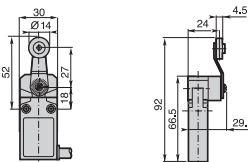

Min. actuating torque **0,08Nm (0,28Nm ⇄)**
Weight **175 g**

G45 - Ø18 nylon roller lever

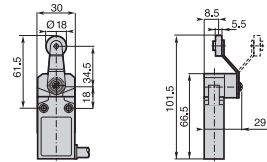

Min. actuating torque **0,08Nm (0,28Nm ⇄)**
Weight **180 g**

G51 - Adjustable lever with Ø18 nylon roller

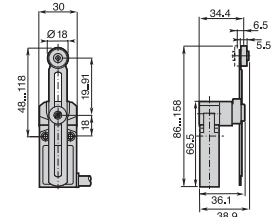

Min. actuating torque **0,08Nm (0,28Nm ⇄)**
Weight **190 g**

Contact Blocks

Z Snap action contacts (1NO + 1NC)	EP1G43ZU	EP1G45ZU	EP1G51ZU
Z2 Snap action contacts (2NC)	EP1G43Z2U	EP1G45Z2U	EP1G51Z2U
Z3 Snap action contacts (2NO)	EP1G43Z3U	EP1G45Z3U	EP1G51Z3U
Z4 Snap action contacts (2NC + 2NO)	EP1G43Z4U	EP1G45Z4U	EP1G51Z4U
X Non overlapping slow action contacts (1NO + 1NC)	EP1G43XU	EP1G45XU	EP1G51XU
X2 Slow action contacts (2NC)	EP1G43X2U	EP1G45X2U	EP1G51X2U
X3 Slow action contacts (2NO)	EP1G43X3U	EP1G45X3U	EP1G51X3U
X4 Non overlapping slow action contacts (2NO + 2NC)	EP1G43X4U	EP1G45X4U	EP1G51X4U

G5100 - Adjustable toothed lever (step 2 mm) with Ø18 nylon roller

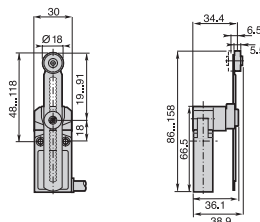

Min. actuating torque **0,08Nm (0,28Nm ⇄)**
Weight **190 g**

G61 - Nylon actuator with stainless steel spring

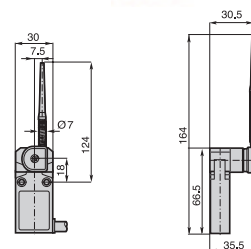

Min. actuating torque **0,08Nm**
Weight **190 g**

G71 - Adjustable Ø3 stainless steel rod lever

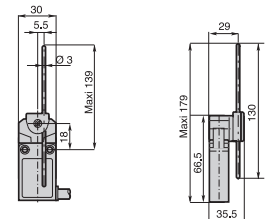

Min. actuating torque **0,08Nm (0,28Nm ⇄)**
Weight **185 g**

Contact Blocks

Z Snap action contacts (1NO + 1NC)	EP1G5100ZU	EP1G61ZU	EP1G71ZU
Z2 Snap action contacts (2NC)	EP1G5100Z2U	EP1G61Z2U	EP1G71Z2U
Z3 Snap action contacts (2NO)	EP1G5100Z3U	EP1G61Z3U	EP1G71Z3U
Z4 Snap action contacts (2NC + 2NO)	EP1G5100Z4U	EP1G61Z4U	EP1G71Z4U
X Non overlapping slow action contacts (1NO + 1NC)	EP1G5100XU	EP1G61XU	EP1G71XU
X2 Slow action contacts (2NC)	EP1G5100X2U	EP1G61X2U	EP1G71X2U
X3 Slow action contacts (2NO)	EP1G5100X3U	EP1G61X3U	EP1G71X3U
X4 Non overlapping slow action contacts (2NO + 2NC)	EP1G5100X4U	EP1G61X4U	EP1G71X4U

Operation diagrams: page 126 - All dimensions are in mm

Limit Switches **EP1G series**

Pre-wired - Plastic Casing IP67 - 30 mm. width

Electrical connection:

Pre-Wired

Cable: PVC 4 x 0,75 mm²

Length: 1 m.

Pre-wired

See page 78 for all the available connection variants

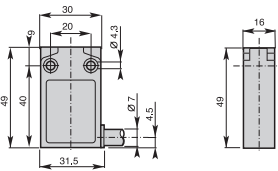

G72 - Adjustable Ø3 fiberglass rod lever

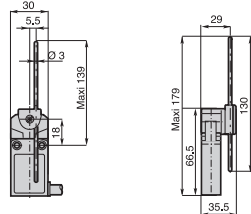

Min. actuating torque **0,08Nm (0,28Nm ⊖)**
Weight **185 g**

G73 - Adjustable Ø6 nylon rod lever

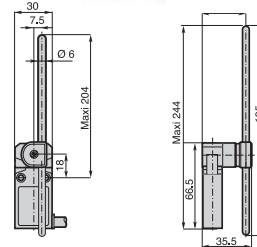

Min. actuating torque **0,08Nm (0,28Nm ⊖)**
Weight **200 g**

G74 - Adjustable Ø6 fiberglass rod lever

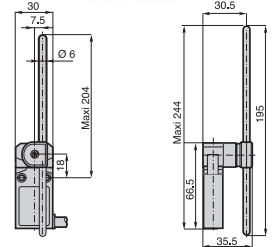

Min. actuating torque **0,08Nm (0,28Nm ⊖)**
Weight **200 g**

Contact Blocks

Z Snap action contacts (1NO + 1NC)	EP1G72ZU	EP1G73ZU	EP1G74ZU
Z2 Snap action contacts (2NC)	EP1G72Z2U	EP1G73Z2U	EP1G74Z2U
Z3 Snap action contacts (2NO)	EP1G72Z3U	EP1G73Z3U	EP1G74Z3U
Z4 Snap action contacts (2NC + 2NO)	EP1G72Z4U	EP1G73Z4U	EP1G74Z4U
X Non overlapping slow action contacts (1NO + 1NC)	EP1G72XU	EP1G73XU	EP1G74XU
X2 Slow action contacts (2NC)	EP1G72X2U	EP1G73X2U	EP1G74X2U
X3 Slow action contacts (2NO)	EP1G72X3U	EP1G73X3U	EP1G74X3U
X4 Non overlapping slow action contacts (2NO + 2NC)	EP1G72X4U	EP1G73X4U	EP1G74X4U

G75 - Adjustable 3x3 square steel rod lever

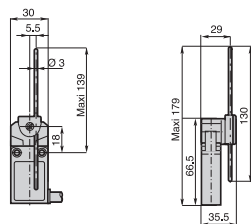

Min. actuating torque **0,08Nm (0,28Nm ⊖)**
Weight **185 g**

G92 - Multidirectional nylon actuator with stainless steel spring

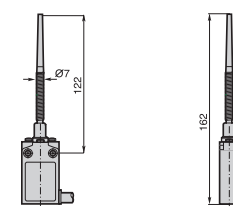

Min. actuating torque **0,10Nm**
Weight **195 g**

G93 - Multidirectional actuator with stainless steel spring

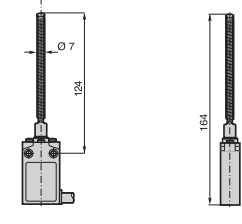

Min. actuating torque **0,10Nm**
Weight **200 g**

Contact Blocks

Z Snap action contacts (1NO + 1NC)	EP1G75ZU	EP1G92ZU	EP1G93ZU
Z2 Snap action contacts (2NC)	EP1G75Z2U	EP1G92Z2U	EP1G93Z2U
Z3 Snap action contacts (2NO)	EP1G75Z3U	EP1G92Z3U	EP1G93Z3U
Z4 Snap action contacts (2NC + 2NO)	EP1G75Z4U	EP1G92Z4U	EP1G93Z4U
X Non overlapping slow action contacts (1NO + 1NC)	EP1G75XU		
X2 Slow action contacts (2NC)	EP1G75X2U		
X3 Slow action contacts (2NO)	EP1G75X3U		
X4 Non overlapping slow action contacts (2NO + 2NC)	EP1G75X4U		

Operation diagrams: page 126 - All dimensions are in mm

Limit Switches **EP2G series**

Pre-wired - Plastic Casing IP67 - 35 mm. width

Electrical connection:

Pre-Wired

Cable: PVC 4 x 0,75 mm²

Length: 1 m.

Pre-wired

See page 78 for all the available connection variants

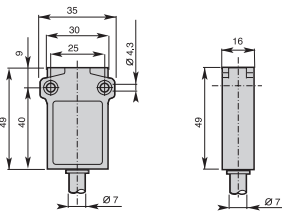

Contact Blocks

Z Snap action contacts (1NO + 1NC)	EP2G11ZU	EP2G12ZU	EP2G13ZU	EP2G14ZU	EP2G15ZU
Z2 Snap action contacts (2NC)	EP2G11Z2U	EP2G12Z2U	EP2G13Z2U	EP2G14Z2U	EP2G15Z2U
Z3 Snap action contacts (2NO)	EP2G11Z3U	EP2G12Z3U	EP2G13Z3U	EP2G14Z3U	EP2G15Z3U
Z4 Snap action contacts (2NC + 2NO)	EP2G11Z4U	EP2G12Z4U	EP2G13Z4U	EP2G14Z4U	EP2G15Z4U
X Non overlapping slow action contacts (1NO + 1NC)	EP2G11XU	EP2G12XU	EP2G13XU	EP2G14XU	EP2G15XU
X2 Slow action contacts (2NC)	EP2G11X2U	EP2G12X2U	EP2G13X2U	EP2G14X2U	EP2G15X2U
X3 Slow action contacts (2NO)	EP2G11X3U	EP2G12X3U	EP2G13X3U	EP2G14X3U	EP2G15X3U
X4 Non overlapping slow action contacts (2NO + 2NC)	EP2G11X4U	EP2G12X4U	EP2G13X4U	EP2G14X4U	EP2G15X4U

G11 - Plain plunger

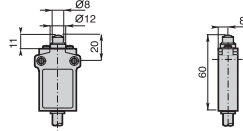

Min. actuating force
Weight **15N (30N ⊖)**
125 g

G1• - Roller plunger

G12: metal roller G13: nylon roller

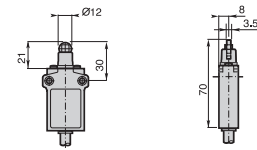

Min. actuating force
Weight **10N (30N ⊖)**
130 g

G1• - Cross roller plunger

G14: metal roller G15: nylon roller

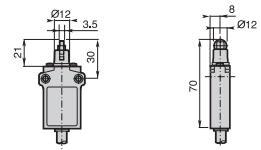

Min. actuating force
Weight **10N (30N ⊖)**
130 g

G16 - Plain plunger with dust protection cup

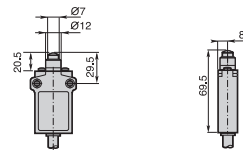

Min. actuating force
Weight **15N (30N ⊖)**
130 g

G21 - Plain plunger with fixing nuts

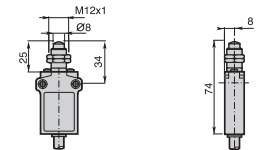

Min. actuating force
Weight **15N (30N ⊖)**
140 g

G2• - Roller plunger with fixing nuts

G22: metal roller G23: nylon roller

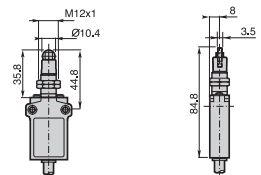

Min. actuating force
Weight **10N (30N ⊖)**
145 g

Contact Blocks

Z Snap action contacts (1NO + 1NC)	EP2G16ZU	EP2G21ZU	EP2G22ZU	EP2G23ZU
Z2 Snap action contacts (2NC)	EP2G16Z2U	EP2G21Z2U	EP2G22Z2U	EP2G23Z2U
Z3 Snap action contacts (2NO)	EP2G16Z3U	EP2G21Z3U	EP2G22Z3U	EP2G23Z3U
Z4 Snap action contacts (2NC + 2NO)	EP2G16Z4U	EP2G21Z4U	EP2G22Z4U	EP2G23Z4U
X Non overlapping slow action contacts (1NO + 1NC)	EP2G16XU	EP2G21XU	EP2G22XU	EP2G23XU
X2 Slow action contacts (2NC)	EP2G16X2U	EP2G21X2U	EP2G22X2U	EP2G23X2U
X3 Slow action contacts (2NO)	EP2G16X3U	EP2G21X3U	EP2G22X3U	EP2G23X3U
X4 Non overlapping slow action contacts (2NO + 2NC)	EP2G16X4U	EP2G21X4U	EP2G22X4U	EP2G23X4U

Operation diagrams: page 126 - All dimensions are in mm

Limit Switches **EP2G series**

Pre-wired - Plastic Casing IP67 - 35 mm. width

Electrical connection:

Pre-Wired

Cable: PVC 4 x 0,75 mm²

Length: 1 m.

Pre-wired

See page 78 for all the available connection variants

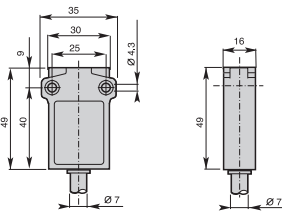

Contact Blocks

Z Snap action contacts (1NO + 1NC)	EP2G24ZU	EP2G25ZU	EP2G31ZU	EP2G32ZU
Z2 Snap action contacts (2NC)	EP2G24Z2U	EP2G25Z2U	EP2G31Z2U	EP2G32Z2U
Z3 Snap action contacts (2NO)	EP2G24Z3U	EP2G25Z3U	EP2G31Z3U	EP2G32Z3U
Z4 Snap action contacts (2NC + 2NO)	EP2G24Z4U	EP2G25Z4U	EP2G31Z4U	EP2G32Z4U
X Non overlapping slow action contacts (1NO + 1NC)	EP2G24XU	EP2G25XU	EP2G31XU	EP2G32XU
X2 Slow action contacts (2NC)	EP2G24X2U	EP2G25X2U	EP2G31X2U	EP2G32X2U
X3 Slow action contacts (2NO)	EP2G24X3U	EP2G25X3U	EP2G31X3U	EP2G32X3U
X4 Non overlapping slow action contacts (2NO + 2NC)	EP2G24X4U	EP2G25X4U	EP2G31X4U	EP2G32X4U

G2• - Cross roller plunger with fixing nuts

G24: metal roller G25: nylon roller

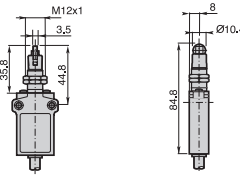

Min. actuating force **10N (30N ⊖)**
Weight **145 g**

G31 - Nylon roller lever

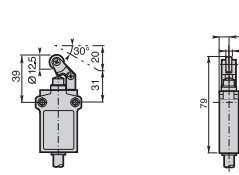

Min. actuating force **7N (24N ⊖)**
Weight **130 g**

G32 - Nylon roller lever

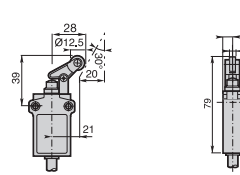

Min. actuating force **7N (24N ⊖)**
Weight **130 g**

G38 - Adjustable nylon roller lever

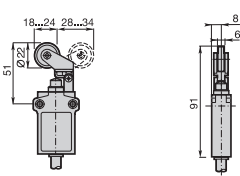

Min. actuating force **7N (24N ⊖)**
Weight **135 g**

G41 - Ø14 nylon roller lever

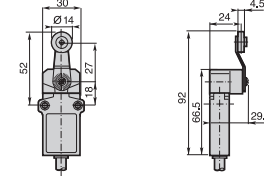

Min. actuating torque **0,08Nm (0,28Nm ⊖)**
Weight **175 g**

G42 - Ø14 metal roller lever

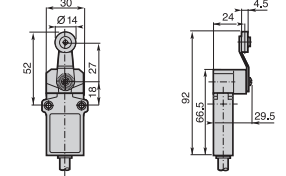

Min. actuating torque **0,08Nm (0,28Nm ⊖)**
Weight **175 g**

Contact Blocks

Z Snap action contacts (1NO + 1NC)	EP2G38ZU	EP2G41ZU	EP2G42ZU
Z2 Snap action contacts (2NC)	EP2G38Z2U	EP2G41Z2U	EP2G42Z2U
Z3 Snap action contacts (2NO)	EP2G38Z3U	EP2G41Z3U	EP2G42Z3U
Z4 Snap action contacts (2NC + 2NO)	EP2G38Z4U	EP2G41Z4U	EP2G42Z4U
X Non overlapping slow action contacts (1NO + 1NC)	EP2G38XU	EP2G41XU	EP2G42XU
X2 Slow action contacts (2NC)	EP2G38X2U	EP2G41X2U	EP2G42X2U
X3 Slow action contacts (2NO)	EP2G38X3U	EP2G41X3U	EP2G42X3U
X4 Non overlapping slow action contacts (2NO + 2NC)	EP2G38X4U	EP2G41X4U	EP2G42X4U

Operation diagrams: page 126 - All dimensions are in mm

Limit Switches **EP2G series**

Pre-wired - Plastic Casing IP67 - 35 mm. width

Electrical connection:

Pre-Wired

Cable: PVC 4 x 0,75 mm²

Length: 1 m.

Pre-wired

See page 78 for all the available connection variants

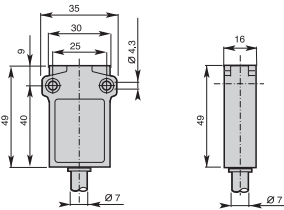

Contact Blocks

Z Snap action contacts (1NO + 1NC)	EP2G43ZU	EP2G45ZU	EP2G51ZU
Z2 Snap action contacts (2NC)	EP2G43Z2U	EP2G45Z2U	EP2G51Z2U
Z3 Snap action contacts (2NO)	EP2G43Z3U	EP2G45Z3U	EP2G51Z3U
Z4 Snap action contacts (2NC + 2NO)	EP2G43Z4U	EP2G45Z4U	EP2G51Z4U
X Non overlapping slow action contacts (1NO + 1NC)	EP2G43XU	EP2G45XU	EP2G51XU
X2 Slow action contacts (2NC)	EP2G43X2U	EP2G45X2U	EP2G51X2U
X3 Non overlapping slow action contacts (2NO)	EP2G43X3U	EP2G45X3U	EP2G51X3U
X4 Non overlapping slow action contacts (2NO + 2NC)	EP2G43X4U	EP2G45X4U	EP2G51X4U

G43 - Ø14 roller lever with ball bearing

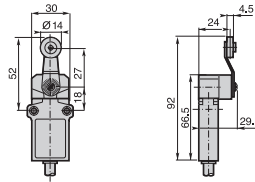

Min. actuating torque **0,08Nm (0,28Nm ⇄)**
Weight **175 g**

G45 - Ø18 nylon roller lever

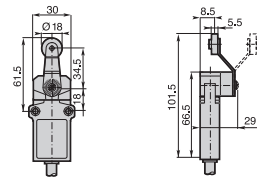

Min. actuating torque **0,08Nm (0,28Nm ⇄)**
Weight **180 g**

G51 - Adjustable lever with Ø18 nylon roller

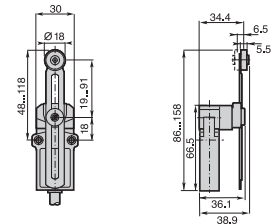

Min. actuating torque **0,08Nm (0,28Nm ⇄)**
Weight **190 g**

G5100 - Adjustable toothed lever (step 2 mm) with Ø18 nylon roller

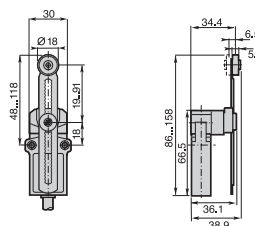

Min. actuating torque **0,08Nm (0,28Nm ⇄)**
Weight **190 g**

G61 - Nylon actuator with stainless steel spring

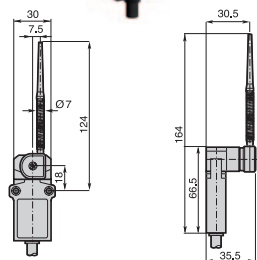

Min. actuating torque **0,10Nm**
Weight **190 g**

G71 - Adjustable Ø3 stainless steel rod lever

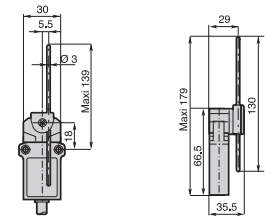

Min. actuating torque **0,08Nm (0,28Nm ⇄)**
Weight **185 g**

Contact Blocks

Z Snap action contacts (1NO + 1NC)	EP2G5100ZU	EP2G61ZU	EP2G71ZU
Z2 Snap action contacts (2NC)	EP2G5100Z2U	EP2G61Z2U	EP2G71Z2U
Z3 Snap action contacts (2NO)	EP2G5100Z3U	EP2G61Z3U	EP2G71Z3U
Z4 Snap action contacts (2NC + 2NO)	EP2G5100Z4U	EP2G61Z4U	EP2G71Z4U
X Non overlapping slow action contacts (1NO + 1NC)	EP2G5100XU	EP2G61XU	EP2G71XU
X2 Slow action contacts (2NC)	EP2G5100X2U	EP2G61X2U	EP2G71X2U
X3 Slow action contacts (2NO)	EP2G5100X3U	EP2G61X3U	EP2G71X3U
X4 Non overlapping slow action contacts (2NO + 2NC)	EP2G5100X4U	EP2G61X4U	EP2G71X4U

Operation diagrams: page 126 - All dimensions are in mm

Limit Switches **EP2G series**

Pre-wired - Plastic Casing IP67 - 35 mm. width

Electrical connection:

Pre-Wired

Cable: PVC 4 x 0,75 mm²

Length: 1 m.

Pre-wired

See page 78 for all the available connection variants

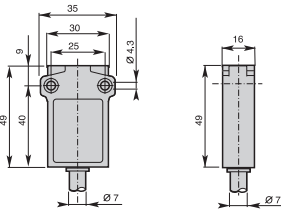

Contact Blocks

Z Snap action contacts (1NO + 1NC)	EP2G72ZU	EP2G73ZU	EP2G74ZU
Z2 Snap action contacts (2NC)	EP2G72Z2U	EP2G73Z2U	EP2G74Z2U
Z3 Snap action contacts (2NO)	EP2G72Z3U	EP2G73Z3U	EP2G74Z3U
Z4 Snap action contacts (2NC + 2NO)	EP2G72Z4U	EP2G73Z4U	EP2G74Z4U
X Non overlapping slow action contacts (1NO + 1NC)	EP2G72XU	EP2G73XU	EP2G74XU
X2 Slow action contacts (2NC)	EP2G72X2U	EP2G73X2U	EP2G74X2U
X3 Slow action contacts (2NO)	EP2G72X3U	EP2G73X3U	EP2G74X3U
X4 Non overlapping slow action contacts (2NO + 2NC)	EP2G72X4U	EP2G73X4U	EP2G74X4U

G72 - Adjustable Ø3 fiberglass rod lever

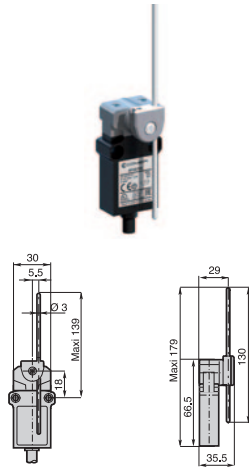

Min. actuating torque **0,08Nm (0,28Nm ⊖)**
Weight **185 g**

G73 - Adjustable Ø6 nylon rod lever

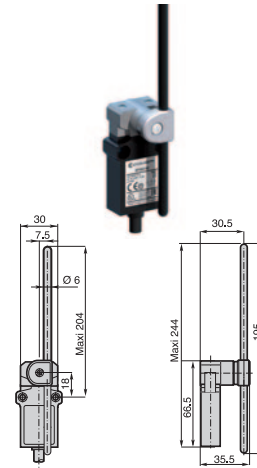

Min. actuating torque **0,08Nm (0,28Nm ⊖)**
Weight **200 g**

G74 - Adjustable Ø6 fiberglass rod lever

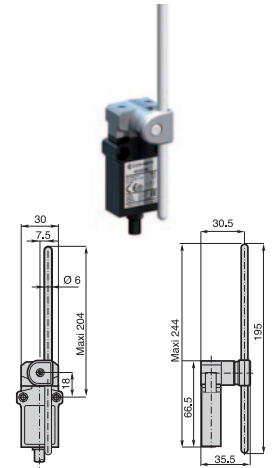

Min. actuating torque **0,08Nm (0,28Nm ⊖)**
Weight **200 g**

G75 - Adjustable 3x3 square steel rod lever

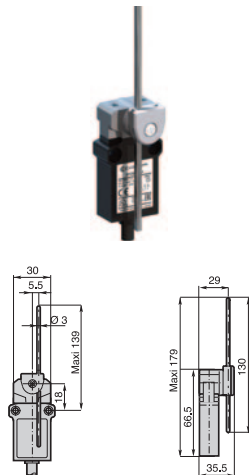

Min. actuating torque **0,08Nm (0,28Nm ⊖)**
Weight **185 g**

G92 - Multidirectional nylon actuator with stainless steel spring

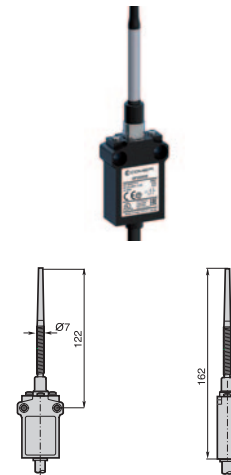

Min. actuating torque **0,12Nm**
Weight **195 g**

G93 - Multidirectional actuator with stainless steel spring

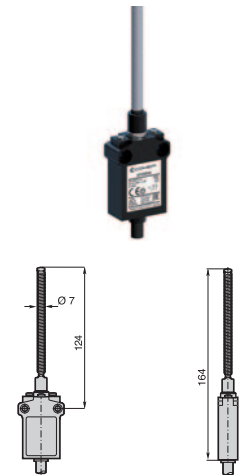

Min. actuating torque **0,12Nm**
Weight **200 g**

Contact Blocks

Z Snap action contacts (1NO + 1NC)	EP2G75ZU	EP2G92ZU	EP2G93ZU
Z2 Snap action contacts (2NC)	EP2G75Z2U	EP2G92Z2U	EP2G93Z2U
Z3 Snap action contacts (2NO)	EP2G75Z3U	EP2G92Z3U	EP2G93Z3U
Z4 Snap action contacts (2NC + 2NO)	EP2G75Z4U	EP2G92Z4U	EP2G93Z4U
X Non overlapping slow action contacts (1NO + 1NC)	EP2G75XU		
X2 Slow action contacts (2NC)	EP2G75X2U		
X2 Slow action contacts (2NO)	EP2G75X3U		
X4 Non overlapping slow action contacts (2NO + 2NC)	EP2G75X4U		

Operation diagrams: page 126 - All dimensions are in mm

Limit Switches EM series

Summary

APPROVALS: UL 508 / CSA C22-2 N. 14 / IEC 60947-5-1



CB-SCHEME certification according to IEC 60947-5-1

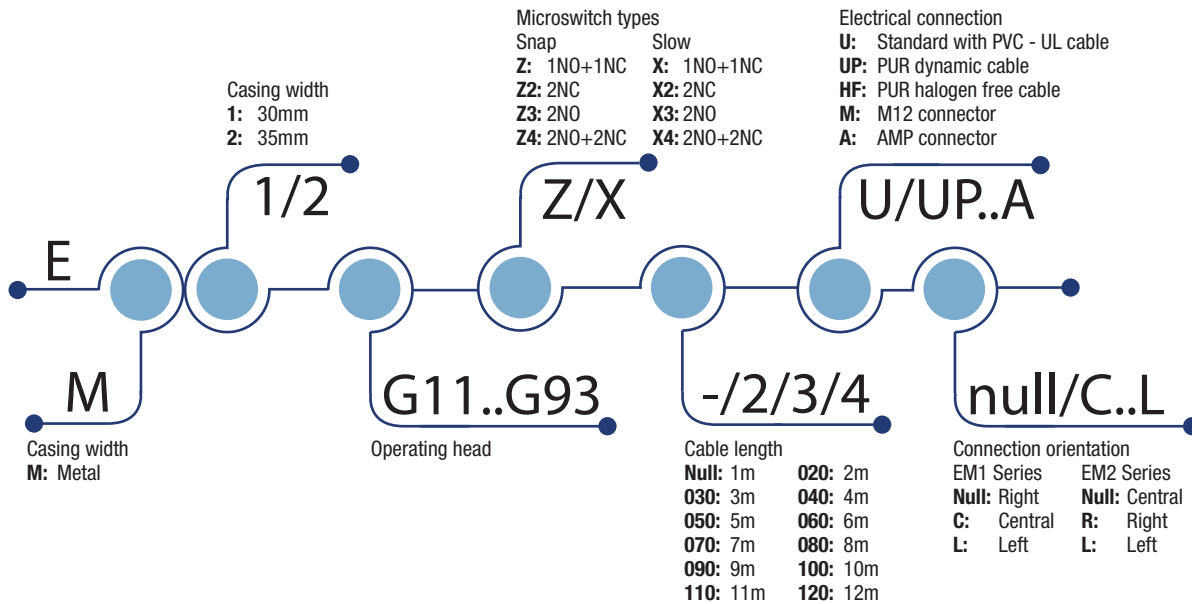

HOW IS IT MADE?

01 A variety of actuators

- Plain plunger
- Roller plunger
- Roller lever, adjustable or not, etc.

02 Wide range of heads

- Assembled using 2 x Ø3 screws or 2 plug

03 Casing:

- 30 or 35 mm. width

04 Mounting screws

- 2 x M4 screws on top part

05 Epoxy resin for IP67 protection degree

06 Contact Block

- Positive opening operation
- Snap action or slow action
- Electrically separated contacts

07 Connecting terminals

- Cable: PVC 4 x 0,75 mm²
- Special cables: Halogen Free or Dynamic PUR
- M12 connector
- AMP connector

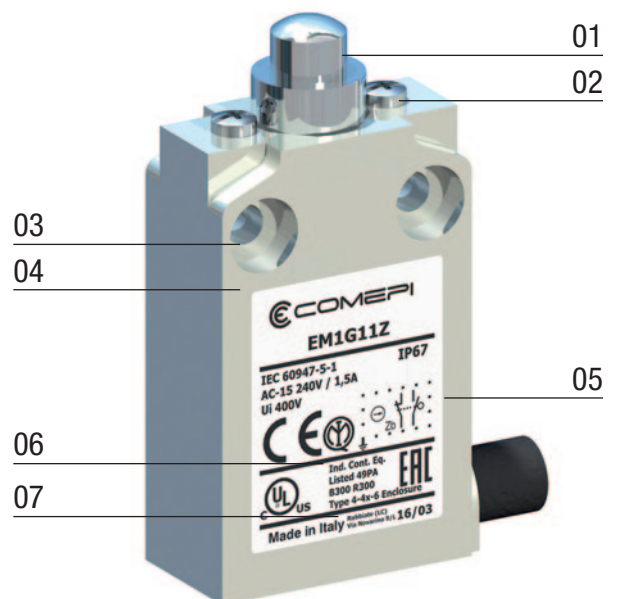

Limit Switches **EM series**

Description

APPLICATIONS

Easy to use, electromechanical limit switches offer specific qualities:

- Visible operation.
- Able to switch strong currents (up to 10 A conventional thermal current).
- Electrically separated contacts.
- Precise operating points (consistency).
- Immune to electromagnetic disturbances.

They are purpose-built detection devices thanks to these characteristics:

- Presence/absence.
- Positioning and travel limit.
- Objects passing/counting.

DESCRIPTION

These limit switches, made zinc alloy (Zamak), sealed with epoxy resin at the base on the box, offer a degree of protection IP67.

The casing come in 2 dimensions: – EM1... 30 mm. width – EM2... 35 mm. width

They comply with the requirements of European Directives (Low Voltage and RoHS) and are conform to European and International Standards.

The CE declaration of these products are available in the download section of website www.comepi.it or by writing to the following email address: tecnico@comepi.it
DDC02 - Limit Switches.

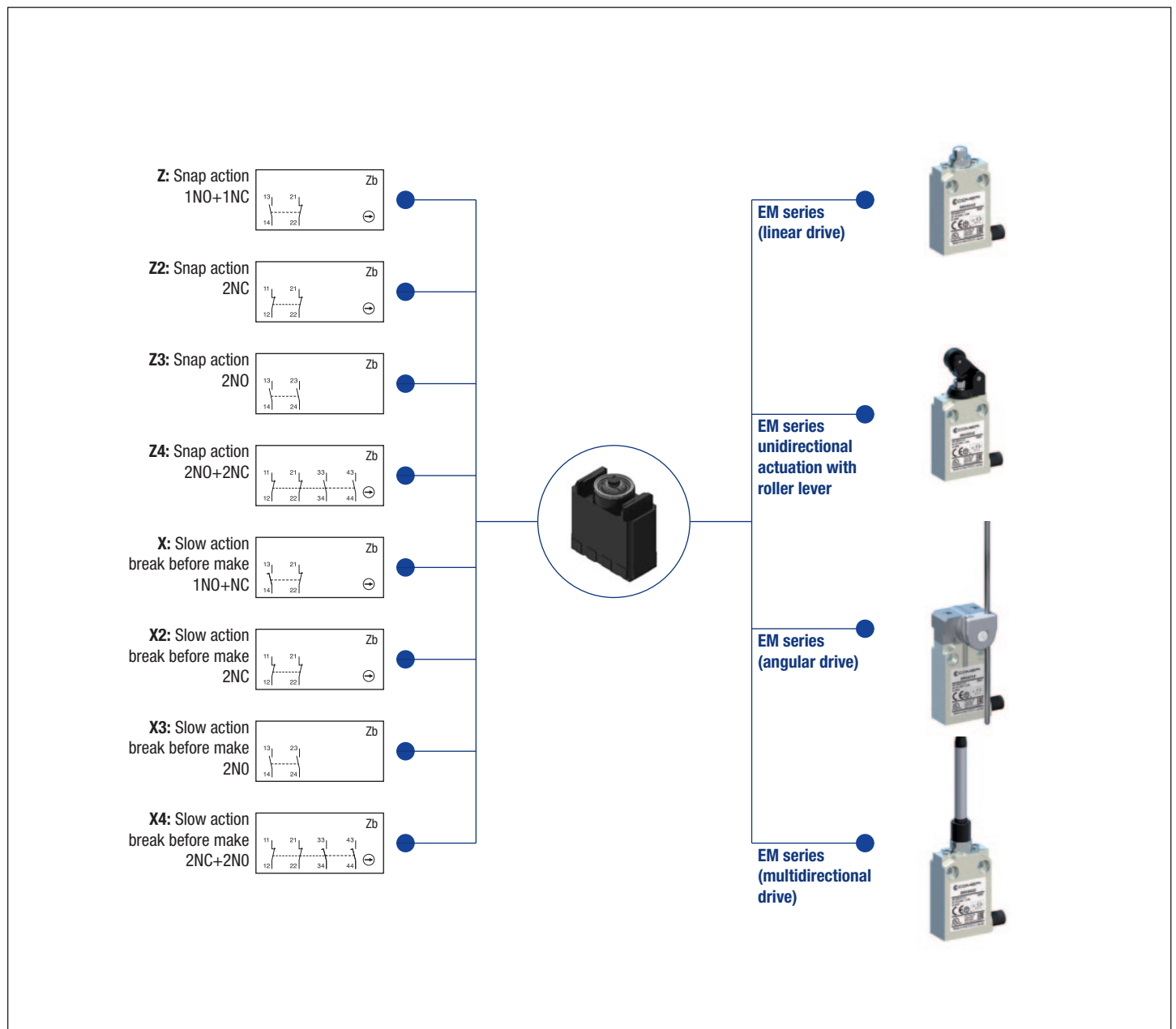

Limit Switches EM series

Technical Data

	EM Series	
Standards	IEC 60947-5-1 EN 60947-5-1	
Air temperature near the device		
– during operation	°C	– 25 ... + 70
– for storage	°C	– 40 ... + 70
Mounting positions	All positions are authorised	
Protection against electrical shocks (acc. to IEC 61140)	Class I	
Degree of protection (according to IEC 60529 and EN 60529)	IP 67	
Degree of protection (according to UL50)	Type 4 - 4X - 6 enclosure ("outdoor use - raintight - watertight - corrosion resistant")	
Switching frequency	Cycles/h	3600
Mechanical durability	10 millions of operations	

Electrical data - Electrical connections

Code	EM_U	EM_UP	EM_HF	EM_LW	EM_M	EM_A
Cable type	5xAWG18 0,75mm ² PVC Style 2517	5xAWG18 dynamic 0,75mm ² PVC Style 20668	5xAWG18 dynamic 0,75mm ² PVC Style 20668	5xAWG18 0,75mm ² Silicone cable	–	–
Min. bend radius	57mm	57mm	57mm	57mm	–	–
Rated insulation voltage U _i	400V	300V	300V	300V	250V	250V
Pollution degree	3	3	3	3	3	3
Rated impulse withstand voltage U _{imp}	4kV	4kV	4kV	4kV	2.5kV	2.5kV
Conventional free air thermal current I _{th}	10A	10A	10A	10A	4A	4A
Short circuit current I _{cc}	1kA	1kA	1kA	1kA	1kA	1kA
Short-circuit protection	10A 500V type gG	10A 500V type gG	10A 500V type gG	4A 500V type gG	4A 500V type gG	4A 500V type gG
AC15	24V 120V 240V	10A 6A 3A	10A 6A 3A	10A 6A 3A	4A 4A 3A	4A 4A 3A
DC13	24V 125V 250V	2.8A 0.55A 0.27A	2.8A 0.55A 0.27A	2.8A 0.55A 0.27A	2.8A 0.55A 0.27A	2.8A 0.55A 0.27A
Approvals	cULus EAC CCC UKCA	cULus EAC CCC UKCA	cULus EAC CCC UKCA	cULus EAC CCC UKCA	IMQ cULus EAC CCC UKCA	EAC UKCA

Code	X2/X3	X4	Z2/Z3	Z4
Connection type	5xAWG18 0,75mm ² PVC Style 2517	9xAWG22 0,5mm ² PVC Style 2517	5xAWG18 0,75mm ² PVC Style 2517	9xAWG22 0,5mm ² PVC Style 2517
Min. bend radius	49mm	49mm	49mm	49mm
Rated insulation voltage U _i	250V	250V	250V	250V
Pollution degree	3	3	3	3
Rated impulse withstand voltage U _{imp}	2.5kV	2.5kV	2.5kV	2.5kV
Conventional free air thermal current I _{th}	4A	4A	4A	4A
Short-circuit protection	4A 500V type gG	4A 500V type gG	4A 500V type gG	4A 500V Type gG
AC15	24V 240V	4A 3A	4A 3A	4A 3A
DC13	24V 250V	2A 0.4A	2A 0.4A	2A /
Approvals	cULus EAC CCC UKCA	cULus EAC CCC UKCA	cULus EAC CCC UKCA	cULus EAC CCC UKCA

Limit Switches **EM series**

Wiring Diagram

Serie EM_U / EM_UP / EM_HF

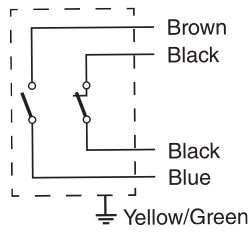

Serie EM_LW

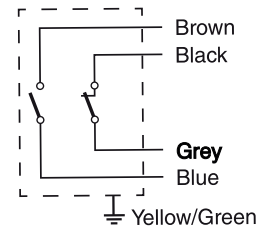

Serie EM_A

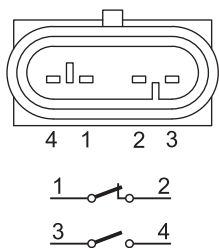

Serie EM_M

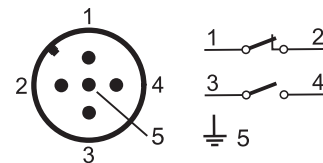

Serie EM_X2 / Z2

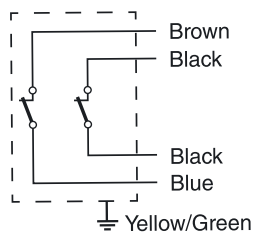

Serie EM_X3 / Z3

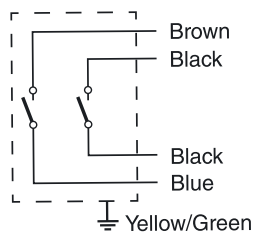

Serie EM_X4 / Z4

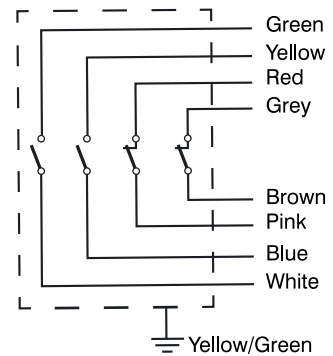

Limit Switches **EM series**

Technical Data



Standard PVC UL cable

All models can be supplied with a standard PVC UL cable.
To order, keep the suffix "U" of the standard
Example: EM1G11ZU

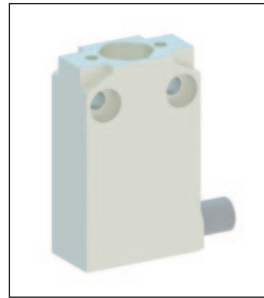

Dynamic PUR cable

greater flexibility characterize these models compared to the UL standard, while maintaining the same features and the same electrical ratings. Moreover, the external sheath, polyurethane made, guarantees more resistance in stern working environments.
To order add the digit "P" at the end of the UL standard part number.
Example: EM1G11ZU ➔ EM1G11ZUP

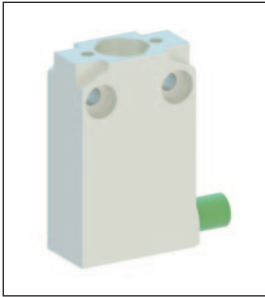

Halogen free PUR cable

The absence of halogens guarantees less fumes and toxic gases released in case of fire. Moreover, the external sheath, polyurethane made, guarantees more resistance in stern working environments.
To order add the digit "HF" at the end of the part number.
Example: EM1G11ZHF

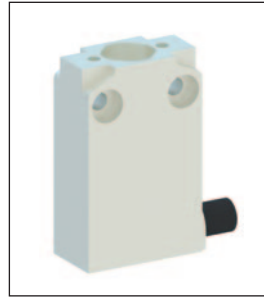

Silicone Cable

Designed to remain flexible even at low temperatures (-40°).
All the models can be supplied with silicone cable.
To order replace the "U" suffix of the standard UL version with suffix "LW".
Example: EM1G11ZU ➔ EM1G11ZLW



AMP connector

All the models can be supplied with AMP connector.
To order replace the "U" suffix of the standard UL version with suffix "A".
Example: EM1G11ZU ➔ EM1G11ZA

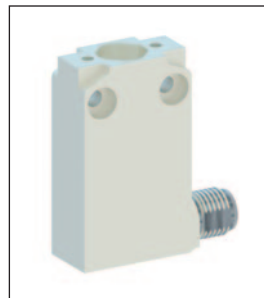

M12 connector

All the models can be supplied with M12 connector.
To order replace the "U" suffix of the standard UL version with suffix "M".
Example: EM1G11ZU ➔ EM1G11ZM

Cable connection orientation



Cable connection orientation

For EM1 Series, standard version is supplied with right electrical connection exit.
Available version with left or central exit: add respectively digit "L" or "C" at the end of the complete part number.
Example: EM1G11ZU ➔ EM1G11ZUL



For EM2 Series, standard version is supplied with central electrical connection exit.
Available version with left or right exit: add respectively digit "L" or "R" at the end of the complete part number.
Example: EM2G11ZU ➔ EM2G11ZUR

Limit Switches **EM series**

Technical Data

Technical data approved by IMQ

Standards		Devices conform with international IEC 60947-5-1 and European EN 60947-5-1 standards
Degree of protection		IP 67
Rated insulation voltage U_i		400 V (degree of pollution 3) (250V for M12 connector)
Rated impulse withstand voltage U_{imp}		4 kV (2.5 kV for M12 connector)
Conventional free air thermal current I_{th}		10 A (4A for M12 connector)
Short-circuit protection - gG (gl) type fuses		10 A (4A for M12 connector)
Rated operational current		
I_e / AC-15	24 V - 50/60 Hz	10 A (except M12 connector)
	400 V - 50/60 Hz	3 A (except M12 connector)
I_e / DC-13	24 V - d.c.	2.8 A
	250 V - d.c.	0.27 A

Technical data approved by UL

Standards		Devices conform with UL 508
Degree of protection:		
EP Series	Type 1 enclosure ("indoor use only")	
Serie Metallo EM	Type 4 - 4X - 6 enclosure ("outdoor use raintight - watertight - corrosion resistant")	
Utilization categories:		
Cable versions	B300 - R300 (C300-R300)	
M12 connector versions	Class-2	

For the complete list of approved products, contact our technical department

IMPLEMENTATION

Operating head orientation

The head can be rotated each 180° (90° for special version with fixing pins).

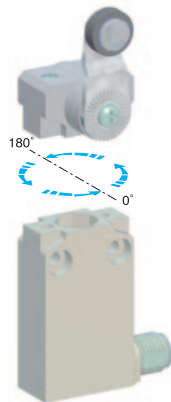

Lever adjustment

The lever of the angular actuators can be adjusted every 10° and round turned in order to obtain the maximum flexibility on the working plan. Recommended tightening torque 0,5 Nm (max 0,8 Nm).

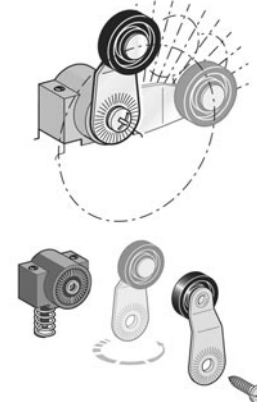

Special Versions



Head installation

Two different solutions are available to fix the head to the body of the switch. The standard solution is made by means of two $\varnothing 3$ screws. On some models it is possible to order the switch with head fixation by means of two pins. This solution will allow a greater resistance to vibrations when needed and it makes it possible for the end user to install the limit switch directly on a panel as shown in the picture on the side.

Please contact our technical department for further details.

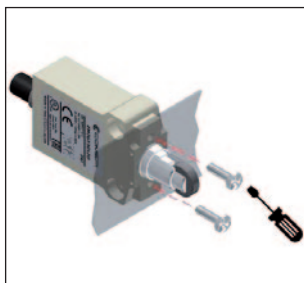

Limit Switches **EM1G series**

Pre-wired - Metal Casing IP67 - 30 mm. width

Electrical connection:

Pre-Wired

Cable: PVC 5 x 0,75 mm²

Length: 1 m.

Pre-wired

See page 92 for all the available connection variants

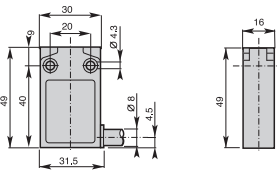

G11 - Plain plunger

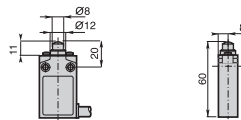

Min. actuating force
Weight **15N (30N ⇄)**
175 g

G1 - Roller plunger

G12: metal roller G13: nylon roller

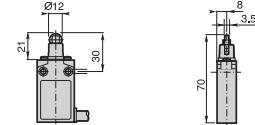

Min. actuating force
Weight **10N (30N ⇄)**
180 g

G1 - Cross roller plunger

G14: metal roller G15: nylon roller

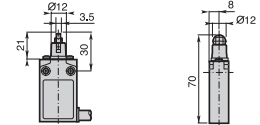

Min. actuating force
Weight **10N (30N ⇄)**
180 g

Contact Blocks

Z Snap action contacts (1NO + 1NC)	EM1G11ZU	EM1G12ZU	EM1G13ZU	EM1G14ZU	EM1G15ZU
Z2 Snap action contacts (2NC)	EM1G11Z2U	EM1G12Z2U	EM1G13Z2U	EM1G14Z2U	EM1G15Z2U
Z3 Snap action contacts (2NO)	EM1G11Z3U	EM1G12Z3U	EM1G13Z3U	EM1G14Z3U	EM1G15Z3U
Z4 Snap action contacts (2NC + 2NO)	EM1G11Z4U	EM1G12Z4U	EM1G13Z4U	EM1G14Z4U	EM1G15Z4U
X Non overlapping slow action contacts (1NO + 1NC)	EM1G11XU	EM1G12XU	EM1G13XU	EM1G14XU	EM1G15XU
X2 Slow action contacts (2NC)	EM1G11X2U	EM1G12X2U	EM1G13X2U	EM1G14X2U	EM1G15X2U
X3 Slow action contacts (2NO)	EM1G11X3U	EM1G12X3U	EM1G13X3U	EM1G14X3U	EM1G15X3U
X4 Non overlapping slow action contacts (2NO + 2NC)	EM1G11X4U	EM1G12X4U	EM1G13X4U	EM1G14X4U	EM1G15X4U

G16 - Plain plunger with dust protection cup

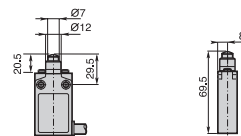

Min. actuating force
Weight **15N (30N ⇄)**
180 g

G17 - Metal roller plunger with dust protection cup

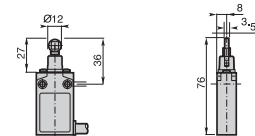

Min. actuating force
Weight **10N (30N ⇄)**
190 g

G18 - Bevel plunger

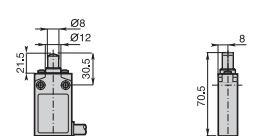

Min. actuating force
Weight **10N (30N ⇄)**
185 g

Contact Blocks

Z Snap action contacts (1NO + 1NC)	EM1G16ZU	EM1G17ZU	EM1G18ZU
Z2 Snap action contacts (2NC)	EM1G16Z2U	EM1G17Z2U	EM1G18Z2U
Z3 Snap action contacts (2NO)	EM1G16Z3U	EM1G17Z3U	EM1G18Z3U
Z4 Snap action contacts (2NC + 2NO)	EM1G16Z4U	EM1G17Z4U	EM1G18Z4U
X Non overlapping slow action contacts (1NO + 1NC)	EM1G16XU	EM1G17XU	EM1G18XU
X2 Slow action contacts (2NC)	EM1G16X2U	EM1G17X2U	EM1G18X2U
X3 Slow action contacts (2NO)	EM1G16X3U	EM1G17X3U	EM1G18X3U
X4 Non overlapping slow action contacts (2NO + 2NC)	EM1G16X4U	EM1G17X4U	EM1G18X4U

Operation diagrams: page 127 - All dimensions are in mm

Limit Switches **EM1G series**

Pre-wired - Metal Casing IP67 - 30 mm. width

Electrical connection:

Pre-Wired

Cable: PVC 5 x 0,75 mm²

Length: 1 m.

Pre-wired

See page 92 for all the available connection variants

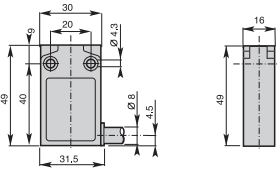

Contact Blocks

Z Snap action contacts (1NO + 1NC)	EM1G21ZU	EM1G22ZU	EM1G23ZU	EM1G24ZU	EM1G25ZU
Z2 Snap action contacts (2NC)	EM1G21Z2U	EM1G22Z2U	EM1G23Z2U	EM1G24Z2U	EM1G25Z2U
Z3 Snap action contacts (2NO)	EM1G21Z3U	EM1G22Z3U	EM1G23Z3U	EM1G24Z3U	EM1G25Z3U
Z4 Snap action contacts (2NC + 2NO)	EM1G21Z4U	EM1G22Z4U	EM1G23Z4U	EM1G24Z4U	EM1G25Z4U
X Non overlapping slow action contacts (1NO + 1NC)	EM1G21XU	EM1G22XU	EM1G23XU	EM1G24XU	EM1G25XU
X2 Slow action contacts (2NC)	EM1G21X2U	EM1G22X2U	EM1G23X2U	EM1G24X2U	EM1G25X2U
X3 Slow action contacts (2NO)	EM1G21X3U	EM1G22X3U	EM1G23X3U	EM1G24X3U	EM1G25X3U
X4 Non overlapping slow action contacts (2NO + 2NC)	EM1G21X4U	EM1G22X4U	EM1G23X4U	EM1G24X4U	EM1G25X4U

G21 - Plain plunger with fixing nuts

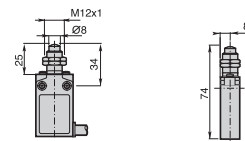

Min. actuating force
Weight

10N (30N ⊖)
190 g

G2• - Roller plunger with fixing nuts

G22: metal roller G23: nylon roller

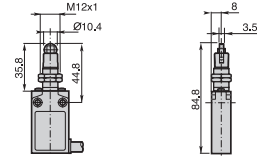

Min. actuating force
Weight

10N (30N ⊖)
195 g

G2• - Cross roller plunger with fixing nuts

G24: metal roller G25: nylon roller

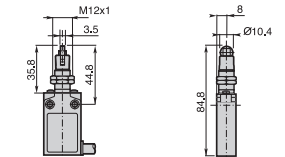

Min. actuating force
Weight

10N (30N ⊖)
195 g

G31 - Nylon roller lever

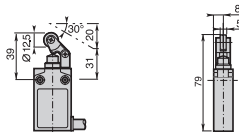

Min. actuating force
Weight

7N (24N ⊖)
180 g

G32 - Nylon roller lever

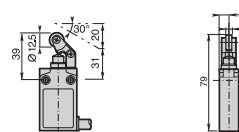

Min. actuating force
Weight

7N (24N ⊖)
180 g

G38 - Adjustable nylon roller lever

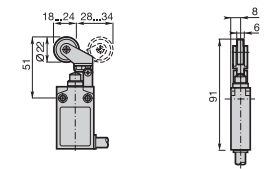

Min. actuating force
Weight

7N (24N ⊖)
185 g

Contact Blocks

Z Snap action contacts (1NO + 1NC)	EM1G31ZU	EM1G32ZU	EM1G38ZU
Z2 Snap action contacts (2NC)	EM1G31Z2U	EM1G32Z2U	EM1G38Z2U
Z3 Snap action contacts (2NO)	EM1G31Z3U	EM1G32Z3U	EM1G38Z3U
Z4 Snap action contacts (2NC + 2NO)	EM1G31Z4U	EM1G32Z4U	EM1G38Z4U
X Non overlapping slow action contacts (1NO + 1NC)	EM1G31XU	EM1G32XU	EM1G38XU
X2 Slow action contacts (2NC)	EM1G31X2U	EM1G32X2U	EM1G38X2U
X3 Slow action contacts (2NO)	EM1G31X3U	EM1G32X3U	EM1G38X3U
X4 Non overlapping slow action contacts (2NO + 2NC)	EM1G31X4U	EM1G32X4U	EM1G38X4U

Operation diagrams: page 127 - All dimensions are in mm

Limit Switches **EM1G series**

Pre-wired - Metal Casing IP67 - 30 mm. width

Electrical connection:

Pre-Wired

Cable: PVC 5 x 0,75 mm²

Length: 1 m.

Pre-wired

See page 92 for all the available connection variants

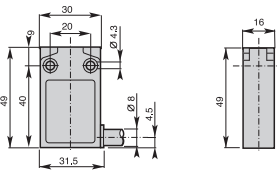

G4• - Ø14 Roller lever

G41: nylon roller G42: metal roller

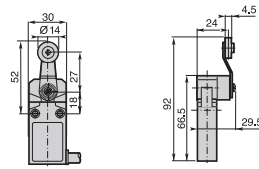

Min. actuating torque **0,08Nm (0,28Nm ⇄)**
Weight **225 g**

G43 - Ø14 Roller lever with ball bearing

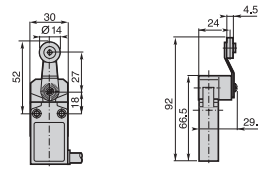

Min. actuating torque **0,08Nm (0,28Nm ⇄)**
Weight **225 g**

G4• - Ø18 Roller lever

G45: nylon roller G46: metal roller

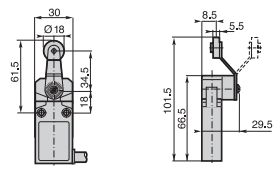

Min. actuating torque **0,08Nm (0,28Nm ⇄)**
Weight **230 g**

Contact Blocks

Z Snap action contacts (1NO + 1NC)	EM1G41ZU	EM1G42ZU	EM1G43ZU	EM1G45ZU	EM1G46ZU
Z2 Snap action contacts (2NC)	EM1G41Z2U	EM1G42Z2U	EM1G43Z2U	EM1G45Z2U	EM1G46Z2U
Z3 Snap action contacts (2NO)	EM1G41Z3U	EM1G42Z3U	EM1G43Z3U	EM1G45Z3U	EM1G46Z3U
Z4 Snap action contacts (2NC + 2NO)	EM1G41Z4U	EM1G42Z4U	EM1G43Z4U	EM1G45Z4U	EM1G46Z4U
X Non overlapping slow action contacts (1NO + 1NC)	EM1G41XU	EM1G42XU	EM1G43XU	EM1G45XU	EM1G46XU
X2 Slow action contacts (2NC)	EM1G41X2U	EM1G42X2U	EM1G43X2U	EM1G45X2U	EM1G46X2U
X3 Slow action contacts (2NO)	EM1G41X3U	EM1G42X3U	EM1G43X3U	EM1G45X3U	EM1G46X3U
X4 Non overlapping slow action contacts (2NO + 2NC)	EM1G41X4U	EM1G42X4U	EM1G43X4U	EM1G45X4U	EM1G46X4U

G5• - Adjustable lever with Ø18 roller

G51: nylon roller G53: metal roller

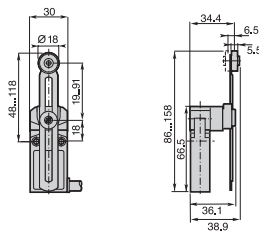

Min. actuating torque **0,08Nm (0,28Nm ⇄)**
Weight **240 g**

G5100 - Adjustable toothed lever (step 2 mm) with Ø18 nylon roller

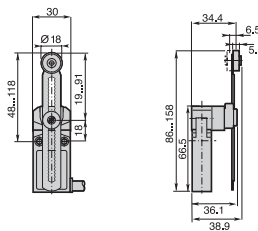

Min. actuating torque **0,08Nm (0,28Nm ⇄)**
Weight **240 g**

G61 - Nylon actuator with stainless steel spring

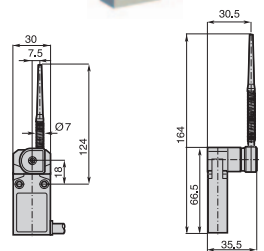

Min. actuating torque **0,08Nm**
Weight **240 g**

Contact Blocks

Z Snap action contacts (1NO + 1NC)	EM1G51ZU	EM1G52ZU	EM1G5100ZU	EM1G61ZU
Z2 Snap action contacts (2NC)	EM1G51Z2U	EM1G52Z2U	EM1G5100Z2U	EM1G61Z2U
Z3 Snap action contacts (2NO)	EM1G51Z3U	EM1G52Z3U	EM1G5100Z3U	EM1G61Z3U
Z4 Snap action contacts (2NC + 2NO)	EM1G51Z4U	EM1G52Z4U	EM1G5100Z4U	EM1G61Z4U
X Non overlapping slow action contacts (1NO + 1NC)	EM1G51XU	EM1G52XU	EM1G5100XU	EM1G61XU
X2 Slow action contacts (2NC)	EM1G51X2U	EM1G52X2U	EM1G5100X2U	EM1G61X2U
X3 Slow action contacts (2NO)	EM1G51X3U	EM1G52X3U	EM1G5100X3U	EM1G61X3U
X4 Non overlapping slow action contacts (2NO + 2NC)	EM1G51X4U	EM1G52X4U	EM1G5100X4U	EM1G61X4U

Operation diagrams: page 127 - All dimensions are in mm

Limit Switches **EM1G series**

Pre-wired - Metal Casing IP67 - 30 mm. width

Electrical connection:

Pre-Wired

Cable: PVC 5 x 0,75 mm²

Length: 1 m.

Pre-wired

See page 92 for all the available connection variants

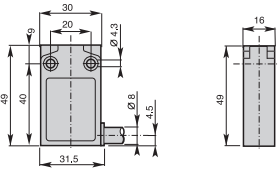

G7• - Adjustable Ø3 rod lever

G71: stainless steel rod G72: fiberglass rod

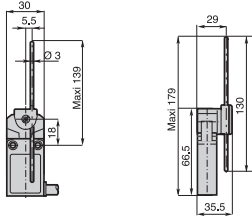

Min. actuating torque **0,08Nm (0,28Nm ⊖)**
Weight **235 g**

G7• - Adjustable Ø6 rod lever

G73: nylon rod G74: fiberglass rod

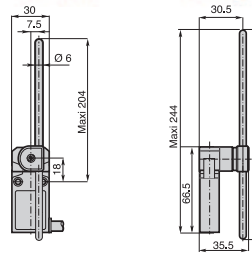

Min. actuating torque **0,08Nm (0,28Nm ⊖)**
Weight **250 g**

G75 - Adjustable 3x3 square steel rod lever

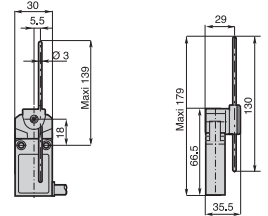

Min. actuating torque **0,08Nm (0,28Nm ⊖)**
Weight **235 g**

Contact Blocks

Z Snap action contacts (1NO + 1NC)	EM1G71ZU	EM1G72ZU	EM1G73ZU	EM1G74ZU	EM1G75ZU
Z2 Snap action contacts (2NC)	EM1G71Z2U	EM1G72Z2U	EM1G73Z2U	EM1G74Z2U	EM1G75Z2U
Z3 Snap action contacts (2NO)	EM1G71Z3U	EM1G72Z3U	EM1G73Z3U	EM1G74Z3U	EM1G75Z3U
Z4 Snap action contacts (2NC + 2NO)	EM1G71Z4U	EM1G72Z4U	EM1G73Z4U	EM1G74Z4U	EM1G75Z4U
X Non overlapping slow action contacts (1NO + 1NC)	EM1G71XU	EM1G72XU	EM1G73XU	EM1G74XU	EM1G75XU
X2 Slow action contacts (2NC)	EM1G71X2U	EM1G72X2U	EM1G73X2U	EM1G74X2U	EM1G75X2U
X3 Slow action contacts (2NO)	EM1G71X3U	EM1G72X3U	EM1G73X3U	EM1G74X3U	EM1G75X3U
X4 Non overlapping slow action contacts (2NO + 2NC)	EM1G71X4U	EM1G72X4U	EM1G73X4U	EM1G74X4U	EM1G75X4U

G92 - Multidirectional nylon actuator with stainless steel spring

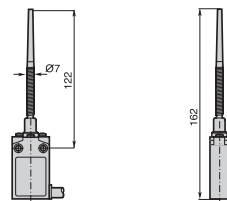

Min. actuating torque **0,10Nm**
Weight **245 g**

G93 - Multidirectional actuator with stainless steel spring

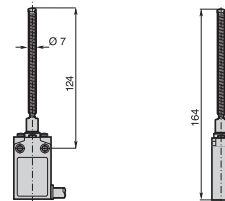

Min. actuating torque **0,10Nm**
Weight **250 g**

Contact Blocks

Z Snap action contacts (1NO + 1NC)	EM1G92ZU	EM1G93ZU
Z2 Snap action contacts (2NC)	EM1G92Z2U	EM1G93Z2U
Z3 Snap action contacts (2NO)	EM1G92Z3U	EM1G93Z3U
Z4 Snap action contacts (2NC + 2NO)	EM1G92Z4U	EM1G93Z4U
X Non overlapping slow action contacts (1NO + 1NC)		
X2 Slow action contacts (2NC)		
X3 Slow action contacts (2NO)		
X4 Non overlapping slow action contacts (2NO + 2NC)		

Operation diagrams: page 127 - All dimensions are in mm

Limit Switches **EM2G series**

Pre-wired - Metal Casing IP67 - 35 mm. width

Electrical connection:

Pre-Wired

Cable: PVC 5 x 0,75 mm²

Length: 1 m.

Pre-wired

See page 92 for all the available connection variants

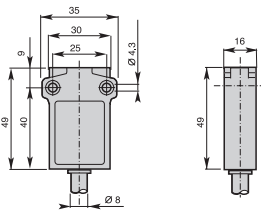

Contact Blocks

	G11 - Plain plunger	G1 - Roller plunger		G1 - Cross roller plunger	
		G12: metal roller	G13: nylon roller	G14: metal roller	G15: nylon roller
Z Snap action contacts (1NO + 1NC)	EM2G11ZU	EM2G12ZU	EM2G13ZU	EM2G14ZU	EM2G15ZU
Z2 Snap action contacts (2NC)	EM2G11Z2U	EM2G12Z2U	EM2G13Z2U	EM2G14Z2U	EM2G15Z2U
Z3 Snap action contacts (2NO)	EM2G11Z3U	EM2G12Z3U	EM2G13Z3U	EM2G14Z3U	EM2G15Z3U
Z4 Snap action contacts (2NC + 2NO)	EM2G11Z4U	EM2G12Z4U	EM2G13Z4U	EM2G14Z4U	EM2G15Z4U
X Non overlapping slow action contacts (1NO + 1NC)	EM2G11XU	EM2G12XU	EM2G13XU	EM2G14XU	EM2G15XU
X2 Slow action contacts (2NC)	EM2G11X2U	EM2G12X2U	EM2G13X2U	EM2G14X2U	EM2G15X2U
X3 Slow action contacts (2NO)	EM2G11X3U	EM2G12X3U	EM2G13X3U	EM2G14X3U	EM2G15X3U
X4 Non overlapping slow action contacts (2NO + 2NC)	EM2G11X4U	EM2G12X4U	EM2G13X4U	EM2G14X4U	EM2G15X4U

G11 - Plain plunger

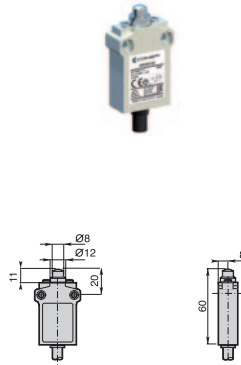

Min. actuating force
Weight **15N (30N ⇄)**
180 g

G1 - Roller plunger

G12: metal roller G13: nylon roller

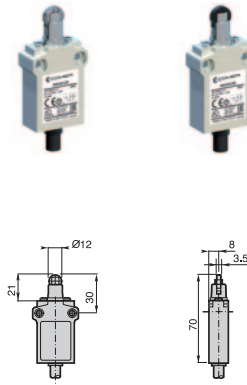

Min. actuating force
Weight **10N (30N ⇄)**
185 g

G1 - Cross roller plunger

G14: metal roller G15: nylon roller

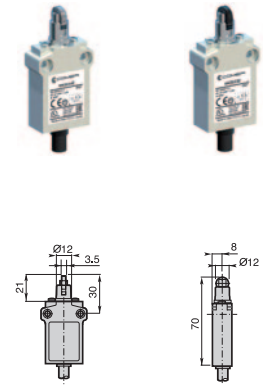

Min. actuating force
Weight **10N (30N ⇄)**
185 g

G16 - Plain plunger with dust protection cup

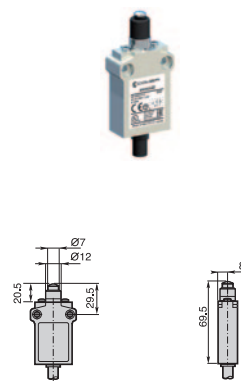

Min. actuating force
Weight **15N (30N ⇄)**
185 g

G17 - Metal roller plunger with dust protection cup

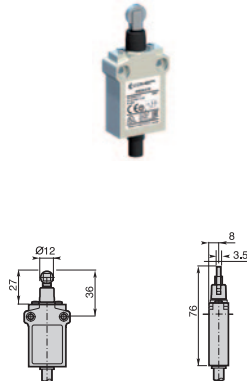

Min. actuating force
Weight **10N (30N ⇄)**
195 g

G18 - Bevel plunger

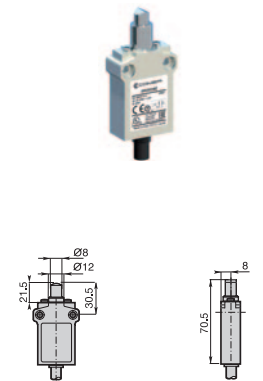

Min. actuating force
Weight **10N (30N ⇄)**
190 g

Contact Blocks

	G16 - Plain plunger with dust protection cup	G17 - Metal roller plunger with dust protection cup	G18 - Bevel plunger
Z Snap action contacts (1NO + 1NC)	EM2G16ZU	EM2G17ZU	EM2G18ZU
Z2 Snap action contacts (2NC)	EM2G16Z2U	EM2G17Z2U	EM2G18Z2U
Z3 Snap action contacts (2NO)	EM2G16Z3U	EM2G17Z3U	EM2G18Z3U
Z4 Snap action contacts (2NC + 2NO)	EM2G16Z4U	EM2G17Z4U	EM2G18Z4U
X Non overlapping slow action contacts (1NO + 1NC)	EM2G16XU	EM2G17XU	EM2G18XU
X2 Slow action contacts (2NC)	EM2G16X2U	EM2G17X2U	EM2G18X2U
X3 Slow action contacts (2NO)	EM2G16X3U	EM2G17X3U	EM2G18X3U
X4 Non overlapping slow action contacts (2NO + 2NC)	EM2G16X4U	EM2G17X4U	EM2G18X4U

Operation diagrams: page 127 - All dimensions are in mm

Limit Switches **EM2G series**

Pre-wired - Metal Casing IP67 - 35 mm. width

Electrical connection:

Pre-Wired

Cable: PVC 5 x 0,75 mm²

Length: 1 m.

Pre-wired

See page 92 for all the available connection variants

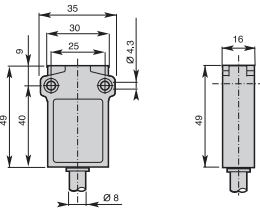

Contact Blocks

Z Snap action contacts (1NO + 1NC)	EM2G21ZU	EM2G22ZU	EM2G23ZU	EM2G24ZU	EM2G25ZU
Z2 Snap action contacts (2NC)	EM2G21Z2U	EM2G22Z2U	EM2G23Z2U	EM2G24Z2U	EM2G25Z2U
Z3 Snap action contacts (2NO)	EM2G21Z3U	EM2G22Z3U	EM2G23Z3U	EM2G24Z3U	EM2G25Z3U
Z4 Snap action contacts (2NC + 2NO)	EM2G21Z4U	EM2G22Z4U	EM2G23Z4U	EM2G24Z4U	EM2G25Z4U
X Non overlapping slow action contacts (1NO + 1NC)	EM2G21XU	EM2G22XU	EM2G23XU	EM2G24XU	EM2G25XU
X2 Slow action contacts (2NC)	EM2G21X2U	EM2G22X2U	EM2G23X2U	EM2G24X2U	EM2G25X2U
X3 Slow action contacts (2NO)	EM2G21X3U	EM2G22X3U	EM2G23X3U	EM2G24X3U	EM2G25X3U
X4 Non overlapping slow action contacts (2NO + 2NC)	EM2G21X4U	EM2G22X4U	EM2G23X4U	EM2G24X4U	EM2G25X4U

G21 - Roller plunger with fixing nuts

Min. actuating force **10N (30N ⊖)**
Weight **195 g**

G2• - Roller plunger with fixing nuts

G22: metal roller G23: nylon roller

Min. actuating force **10N (30N ⊖)**
Weight **200 g**

G2• - Cross roller plunger with fixing nuts

G24: metal roller G25: nylon roller

Min. actuating force **10N (30N ⊖)**
Weight **200 g**

G31 - Nylon roller lever

Min. actuating force **7N (24N ⊖)**
Weight **185 g**

G32 - Nylon roller lever

Min. actuating force **7N (24N ⊖)**
Weight **185 g**

G38 - Adjustable nylon roller lever

Min. actuating force **7N (24N ⊖)**
Weight **190 g**

Contact Blocks

Z Snap action contacts (1NO + 1NC)	EM2G31ZU	EM2G32ZU	EM2G38ZU
Z2 Snap action contacts (2NC)	EM2G31Z2U	EM2G32Z2U	EM2G38Z2U
Z3 Snap action contacts (2NO)	EM2G31Z3U	EM2G32Z3U	EM2G38Z3U
Z4 Snap action contacts (2NC + 2NO)	EM2G31Z4U	EM2G32Z4U	EM2G38Z4U
X Non overlapping slow action contacts (1NO + 1NC)	EM2G31XU	EM2G32XU	EM2G38XU
X2 Slow action contacts (2NC)	EM2G31X2U	EM2G32X2U	EM2G38X2U
X3 Slow action contacts (2NO)	EM2G31X3U	EM2G32X3U	EM2G38X3U
X4 Non overlapping slow action contacts (2NO + 2NC)	EM2G31X4U	EM2G32X4U	EM2G38X4U

Operation diagrams: page 127 - All dimensions are in mm

Limit Switches **EM2G series**

Pre-wired - Metal Casing IP67 - 35 mm. width

Electrical connection:

Pre-Wired

Cable: PVC 5 x 0,75 mm²

Length: 1 m.

Pre-wired

See page 92 for all the available connection variants

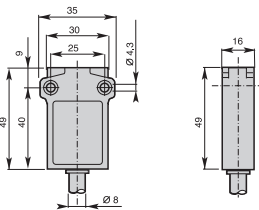

G4• - Ø14 roller lever

G41: nylon roller G42: metal roller

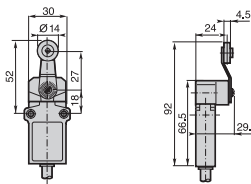
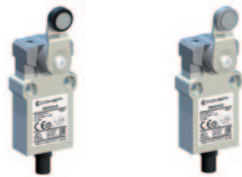

Min. actuating torque **0,08Nm (0,28Nm ⊖)**
Weight **230 g**

G43 - Ø14 roller lever with ball bearing

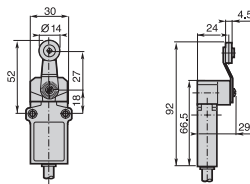

Min. actuating torque **0,08Nm (0,28Nm ⊖)**
Weight **230 g**

G4• - Ø18 metal lever

G45: nylon roller G46: nylon roller

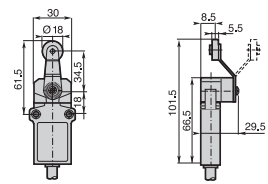

Min. actuating torque **0,08Nm (0,28Nm ⊖)**
Weight **235 g**

Contact Blocks

Z Snap action contacts (1NO + 1NC)	EM2G41ZU	EM2G42ZU	EM2G43ZU	EM2G45ZU	EM2G46ZU
Z2 Snap action contacts (2NC)	EM2G41Z2U	EM2G42Z2U	EM2G43Z2U	EM2G45Z2U	EM2G46Z2U
Z3 Snap action contacts (2NO)	EM2G41Z3U	EM2G42Z3U	EM2G43Z3U	EM2G45Z3U	EM2G46Z3U
Z4 Snap action contacts (2NC + 2NO)	EM2G41Z4U	EM2G42Z4U	EM2G43Z4U	EM2G45Z4U	EM2G46Z4U
X Non overlapping slow action contacts (1NO + 1NC)	EM2G41XU	EM2G42XU	EM2G43XU	EM2G45XU	EM2G46XU
X2 Slow action contacts (2NC)	EM2G41X2U	EM2G42X2U	EM2G43X2U	EM2G45X2U	EM2G46X2U
X3 Slow action contacts (2NO)	EM2G41X3U	EM2G42X3U	EM2G43X3U	EM2G45X3U	EM2G46X3U
X4 Non overlapping slow action contacts (2NO + 2NC)	EM2G41X4U	EM2G42X4U	EM2G43X4U	EM2G45X4U	EM2G46X4U

G5• - Adjustable lever with Ø18 roller

G51: nylon roller G53: metal roller

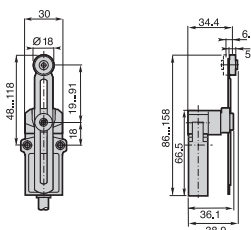

Min. actuating torque **0,08Nm (0,28Nm ⊖)**
Weight **245 g**

G5100 - Adjustable toothed lever (stem 2 mm) with Ø18 nylon roller

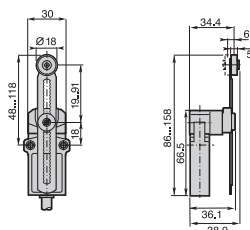

Min. actuating torque **0,08Nm (0,28Nm ⊖)**
Weight **245 g**

G61 - Nylon actuator with stainless steel spring

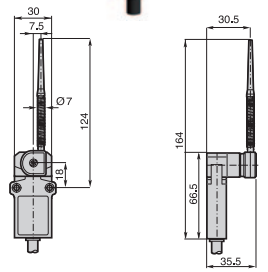

Min. actuating torque **0,08Nm**
Weight **245 g**

Contact Blocks

Z Snap action contacts (1NO + 1NC)	EM2G51ZU	EM2G53ZU	EM2G5100ZU	EM2G61ZU
Z2 Snap action contacts (2NC)	EM2G51Z2U	EM2G53Z2U	EM2G5100Z2U	EM2G61Z2U
Z3 Snap action contacts (2NO)	EM2G51Z3U	EM2G53Z3U	EM2G5100Z3U	EM2G61Z3U
Z4 Snap action contacts (2NC + 2NO)	EM2G51Z4U	EM2G53Z4U	EM2G5100Z4U	EM2G61Z4U
X Non overlapping slow action contacts (1NO + 1NC)	EM2G51XU	EM2G53XU	EM2G5100XU	EM2G61XU
X2 Slow action contacts (2NC)	EM2G51X2U	EM2G53X2U	EM2G5100X2U	EM2G61X2U
X3 Slow action contacts (2NO)	EM2G51X3U	EM2G53X3U	EM2G5100X3U	EM2G61X3U
X4 Non overlapping slow action contacts (2NO + 2NC)	EM2G51X4U	EM2G53X4U	EM2G5100X4U	EM2G61X4U

Operation diagrams: page 127 - All dimensions are in mm

Limit Switches **EM2G series**

Pre-wired - Metal Casing IP67 - 35 mm. width

Electrical connection:

Pre-Wired

Cable: PVC 5 x 0,75 mm²

Length: 1 m.

Pre-wired

See page 92 for all the available connection variants

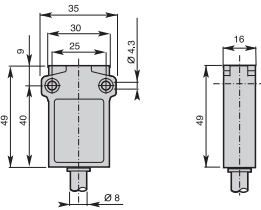

Contact Blocks

Z Snap action contacts (1NO + 1NC)	EM2G71ZU	EM2G72ZU	EM2G73ZU	EM2G74ZU	EM2G75ZU
Z2 Snap action contacts (2NC)	EM2G71Z2U	EM2G72Z2U	EM2G73Z2U	EM2G74Z2U	EM2G75Z2U
Z3 Snap action contacts (2NO)	EM2G71Z3U	EM2G72Z3U	EM2G73Z3U	EM2G74Z3U	EM2G75Z3U
Z4 Snap action contacts (2NC + 2NO)	EM2G71Z4U	EM2G72Z4U	EM2G73Z4U	EM2G74Z4U	EM2G75Z4U
X Non overlapping slow action contacts (1NO + 1NC)	EM2G71XU	EM2G72XU	EM2G73XU	EM2G74XU	EM2G75XU
X2 Slow action contacts (2NC)	EM2G71X2U	EM2G72X2U	EM2G73X2U	EM2G74X2U	EM2G75X2U
X3 Slow action contacts (2NO)	EM2G71X3U	EM2G72X3U	EM2G73X3U	EM2G74X3U	EM2G75X3U
X4 Non overlapping slow action contacts (2NO + 2NC)	EM2G71X4U	EM2G72X4U	EM2G73X4U	EM2G74X4U	EM2G75X4U

G7• - Adjustable Ø3 rod lever

G71: Stainless steel rod G72: fiberglass rod

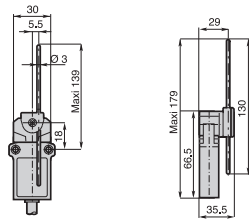

Min. actuating torque **0,08Nm (0,28Nm ⊖)**
Weight **240 g**

G7• - Adjustable Ø6 rod lever

G73: nylon rod G74: fiberglass rod

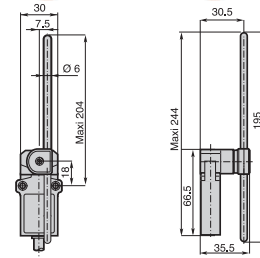

Min. actuating torque **0,08Nm (0,28Nm ⊖)**
Weight **255 g**

G75 - Adjustable 3x3 square steel rod lever

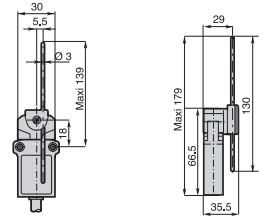

Min. actuating torque **0,08Nm (0,28Nm ⊖)**
Weight **240 g**

G92 - Multidirectional nylon actuator with stainless steel spring

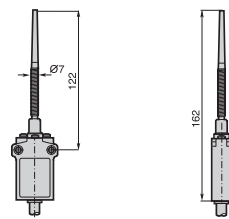

Min. actuating torque **0,10Nm**
Weight **250 g**

G93 - Multidirectional actuator with stainless steel spring

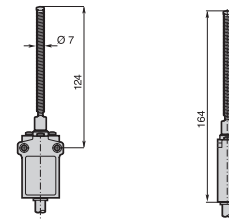

Min. actuating torque **0,10Nm**
Weight **255 g**

Contact Blocks

Z Snap action contacts (1NO + 1NC)	EM2G92ZU	EM2G93ZU
Z2 Snap action contacts (2NC)	EM2G92Z2U	EM2G93Z2U
Z3 Snap action contacts (2NO)	EM2G92Z3U	EM2G93Z3U
Z4 Snap action contacts (2NC + 2NO)	EM2G92Z4U	EM2G93Z4U
X Non overlapping slow action contacts (1NO + 1NC)		
X2 Slow action contacts (2NC)		
X3 Slow action contacts (2NO)		
X4 Non overlapping slow action contacts (2NO + 2NC)		

Limit Switches GP series

Position limit switches - Description

APPROVALS: UL 508 / CSA C22-2 N. 14



Configuration

- H7601W02T: 4 Maintained positions - stop at 180° in each direction
Cross rods 2x200mm
1NC+1NC staggered
- H7602W02T: 4 Maintained positions - free rotation
Cross rods 2x200mm
1NC+1NC staggered
- H7603X11T: 3 Maintained positions
Cross rods 2x200mm
1NO+1NC

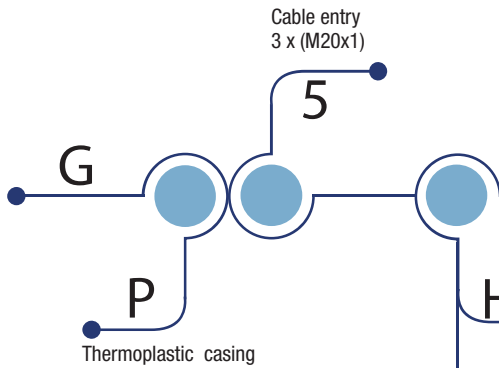

01W02T/02W02T/03X11T

H76

H77

H78

03X11T

01X11T

Configuration

- H7703X11T: 3 Maintained positions
T rods 1x200mm 1x300mm
1NO+1NC
- H7801X11T: Spring return
Rod with roller
1NO+1NC



Limit Switches **GP series**

Position limit switches - Description

Simple and functional

- Limit switch with slowdown and stop function in both directions.
- NC contacts with positive opening operation suitable for safety function.

High performance

- Enclosure in thermoplastic material
- Protection degree IP66 - IP67
- Operating temperature from -53°C to +80°C
- Maximum operation speed 3m/s

Description and application

- New position limit switch designed for linear movement control (X and Y axes).
- Sturdy and reliable, GP series, is suitable for use in harsh operating conditions:
 - Bridge cranes and gantry cranes
 - Mobile cranes
 - Hoists
 - Tower cranes
 - Port cranes
 - etc ...

Options

- Cross rods with 4 maintained positions every 90°
- Cross or T rods with 3 maintained position every 90°
- Single rod or rod with roller with 65° movements and spring return
- 2 slow action switches with 1NC+1NC staggered contacts
- 2 slow action switches with 1NO+1NC contacts

How is made?

- 01** Two contact blocks
- 02** Operating head
- 03** Type of actuators: cross rods, singler rod, rod with roller
- 04** Two fixing holes
- 05** 3x cable inlets

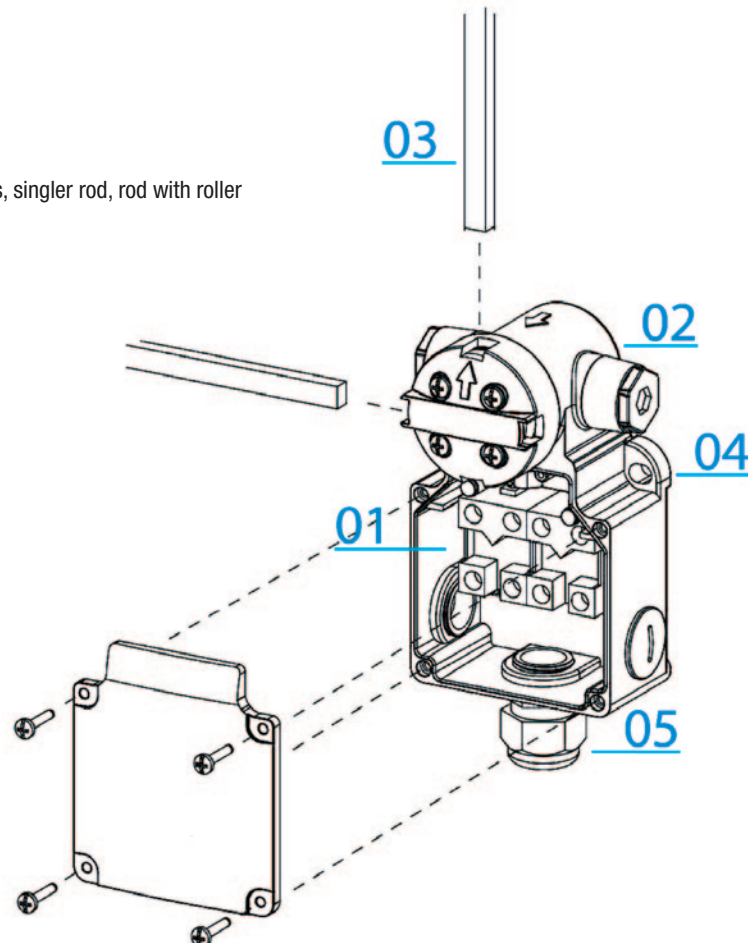

Limit Switches **GP series**

Position limit switches - Description

	GP Series	
Standards	EN 60947-1, EN 60947-5-1 EN 60204-1	
Certifications - Approvals	cULus - UKCA	
Air temperature near the device		
– during operation	°C	– 53 ... + 80
– for storage	°C	– 53 ... + 80
Mounting positions	All positions are authorised	
Protection against electrical shocks (acc. to IEC 61140)	Class II	
Degree of protection (according to IEC 60529 and EN 60529)	IP 67	

Electrical Data

Rated insulation voltage U_i - according to IEC 60947-1 and EN 60947-1 - according to UL 508 and CSA C22-2 n° 14			500 V (degree of pollution 3) A 600, Q 600
Rated impulse withstand voltage U_{imp} (according to IEC 60947-1 and EN 60947-1)	kV		6
Conventional free air thermal current I_{th} (according to IEC 60947-5-1) $\theta < 40\text{ °C}$	A		10
Short-circuit protection $U_e < 500\text{ V a.c.}$ - gG (gl) type fuses	A		10
Rated operational current I_e / AC-15 (according to IEC 60947-5-1)	24 V - 50/60 Hz 120 V - 50/60 Hz 400 V - 50/60 Hz	A A A	10 6 4
I_e / DC-13 (according to IEC 60947-5-1)	24 V - d.c. 125 V - d.c. 250 V - d.c.	A A A	6 0.55 0.4
Switching frequency	Cycles/h		3600
Load factor			0.5
Resistance between contacts	m Ω		25
Connecting terminals	M3.5 (+, -) pozidriv 2 screw with cable clamp		
Terminal for protective conductor	-		
Recommended tightening torque	Plastic		
Cover	0,5Nm, max 0,8		
Head	0,5Nm, max 0,8		
Microswitch	0,8Nm, max 0,9		
Connecting capacity	1 or 2 x mm ²		0.75 ... 2.5
Terminal marking	According to IEC 60947-5-1		
Mechanical durability	2x10 ⁶ operations @ 2A / 240 Vac		
Electrical durability (according to IEC 60947-5-1)	Utilization categories AC-15 and DC-13 (Load factor of 0.5 according to curves below)		

Actuating dimensions

Cross and T rods

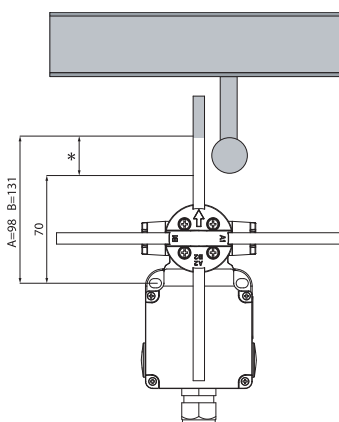

- Maintained positions every 90°
- Average angle for tripping: 48°
- Maximum impact speed: 3 m/s
- A** Rod length: 200 mm
- B** Rod length: 300 mm
- * Actuation area

Rod with roller

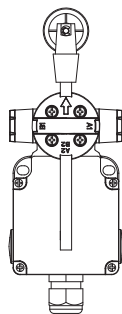

- Pre-travel angle for rotation contact operation: 24°
- Maximum rotation angle: 65°
- Maximum impact speed: 3 m/s

AC-15 - Slow action

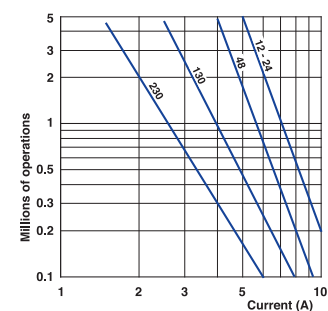

DC-13	Slow action	
	Power breaking for a durability of 5 million operating cycles	
Voltage	24 V	12 W
Voltage	48 V	9 W
Voltage	110 V	6 W

Limit Switches **GP series**

Position limit switches

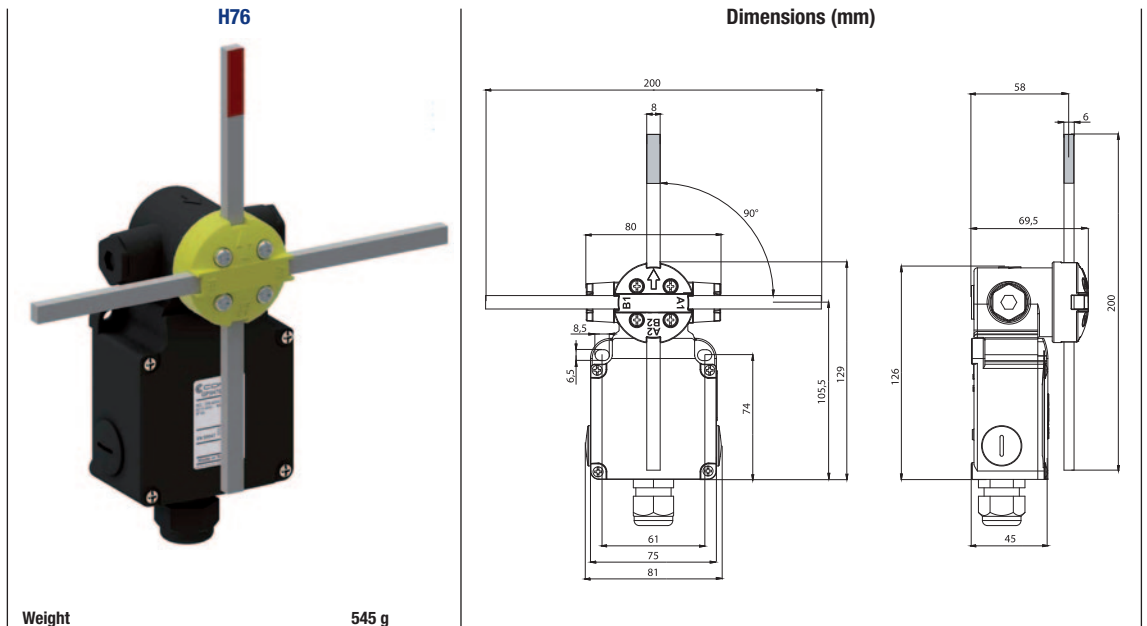

Configuration

Weight **545 g**

4 maintained positions	GP5H7601W02T
Stop at 180° in each direction	
4 maintained positions	GP5H7602W02T
Free rotation	

Position Limit Switches - Operation

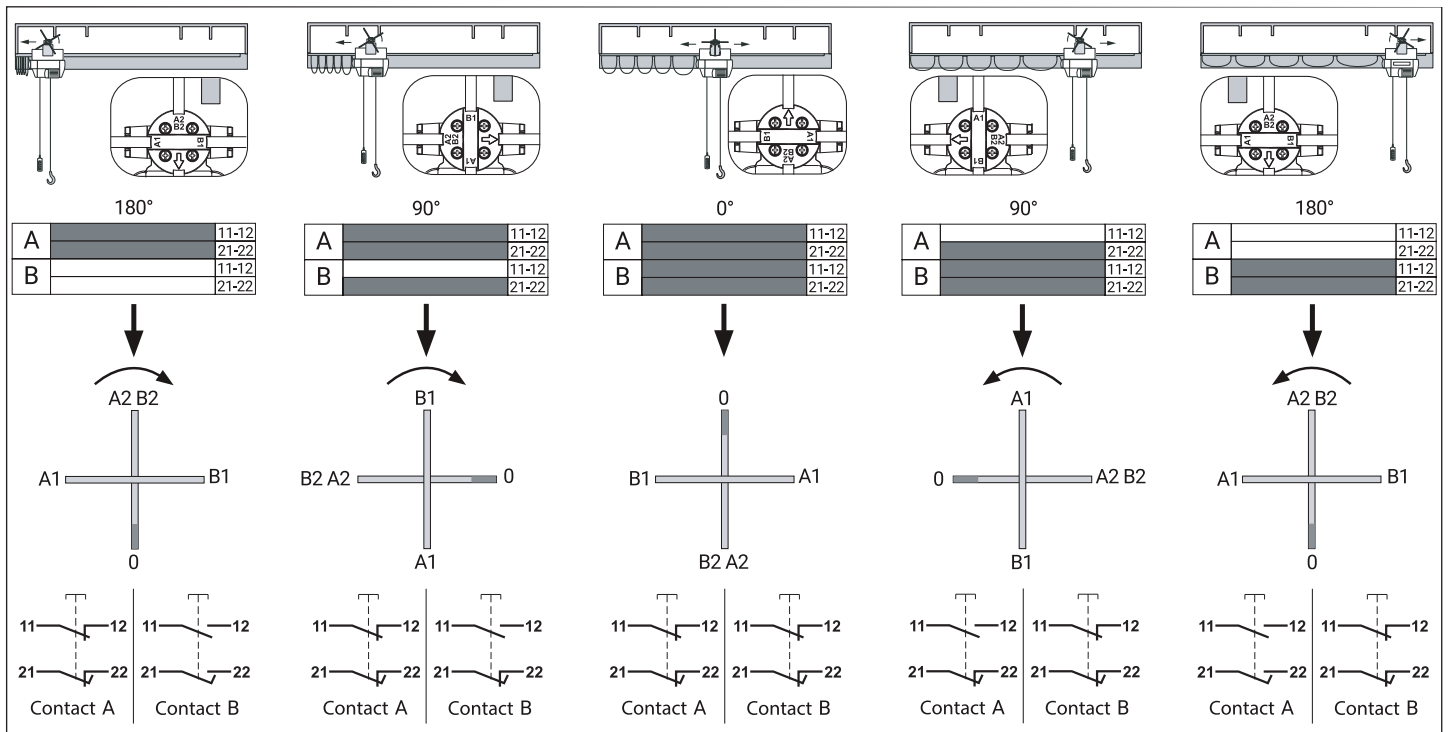

↓ ARROW symbol marked on the head

↻ Rotation direction

ATTENTION: do not turn the head more than 180° in either direction for model GP5H7601W02T.

Limit Switches GP series

Position limit switches - Description

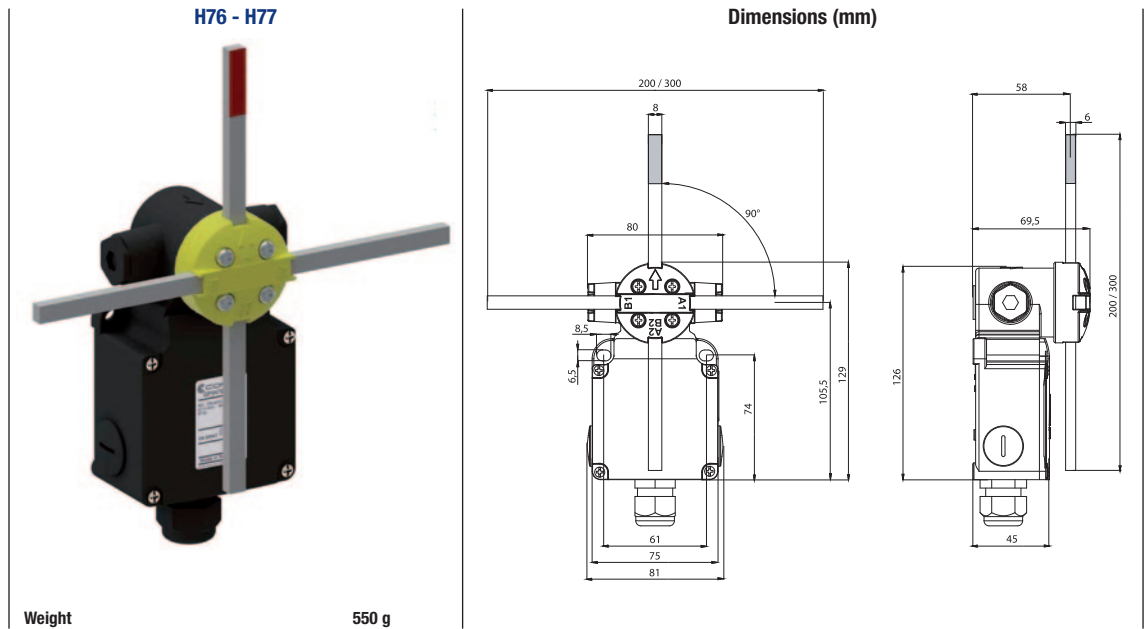

Configuration

Weight

550 g

3 maintained positions

Cross rods 2x200mm

GP5H7603X11T

3 maintained position

T rods 1x200mm - 1x300mm

GP5H7703X11T

Position Limit Switches - Operation

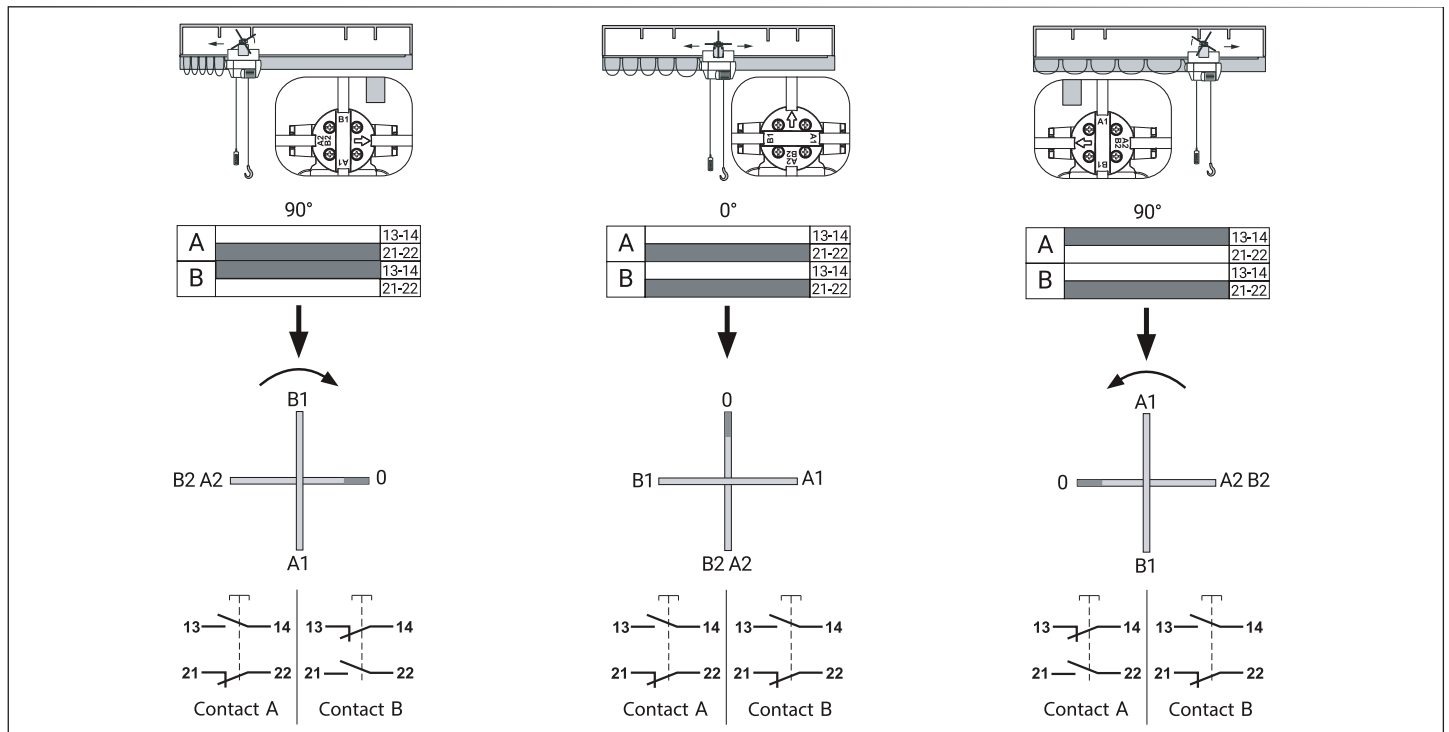

Limit Switches **GP series**

Position limit switches - Description



H78

Dimensions (mm)

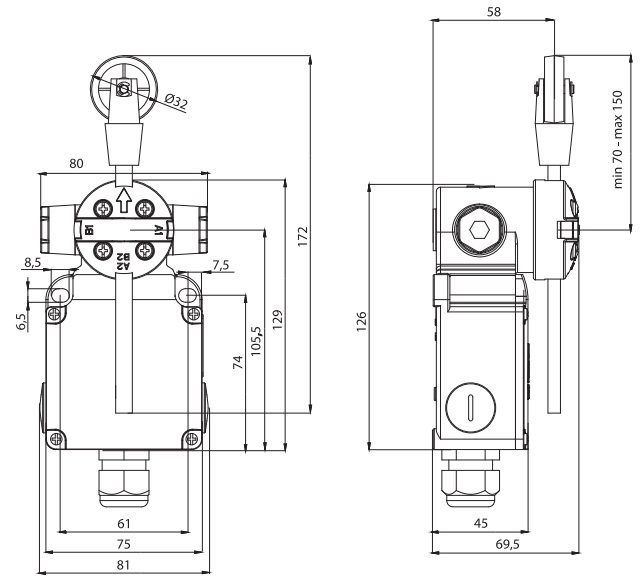

Configuration

Weight

525 g

Spring return
Rod with roller

GP5H7801X11T

Position Limit Switches - Operation

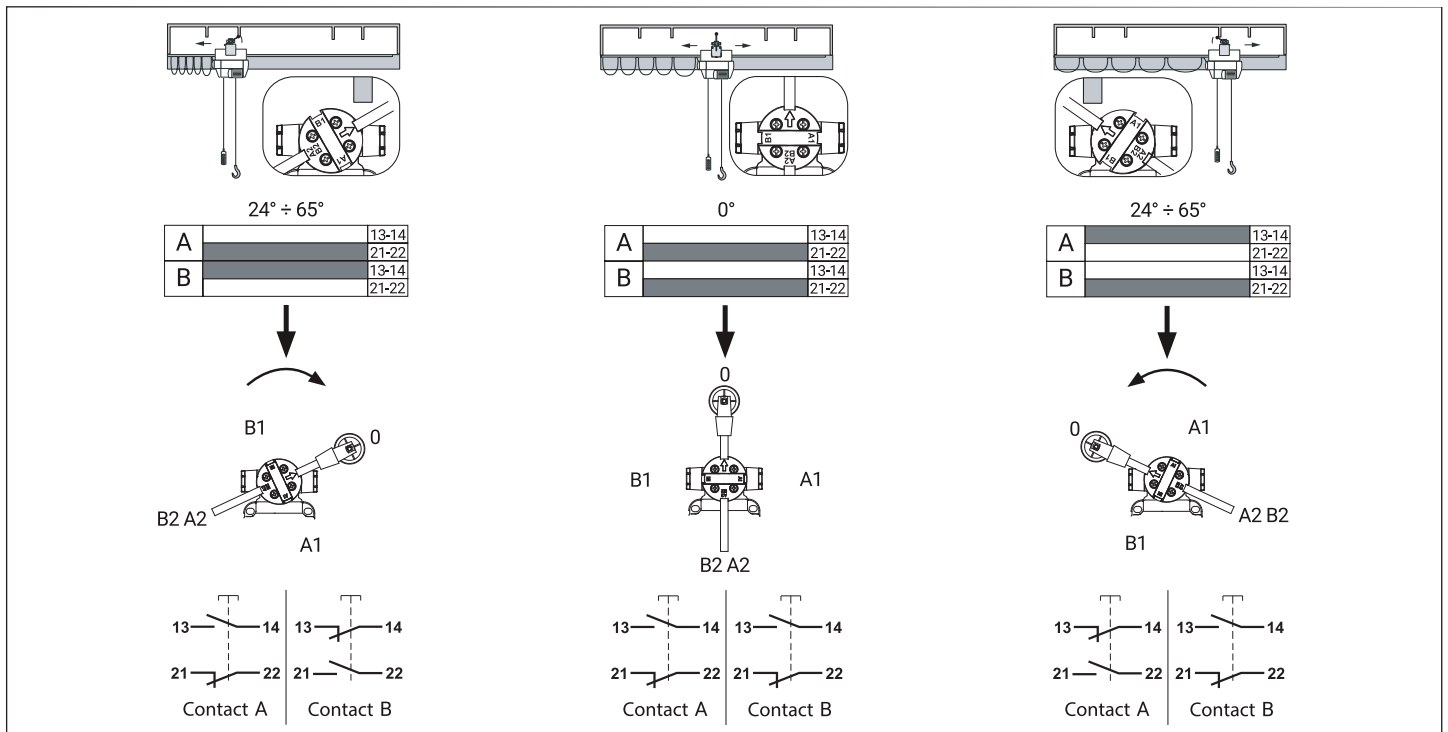

↓ ARROW symbol marked on the head

↻ Rotation direction

ATTENTION: do not turn the head more than 65° in either direction.

Control Cabinet Devices

Linear LED Lamp - Summary

APPROVALS:

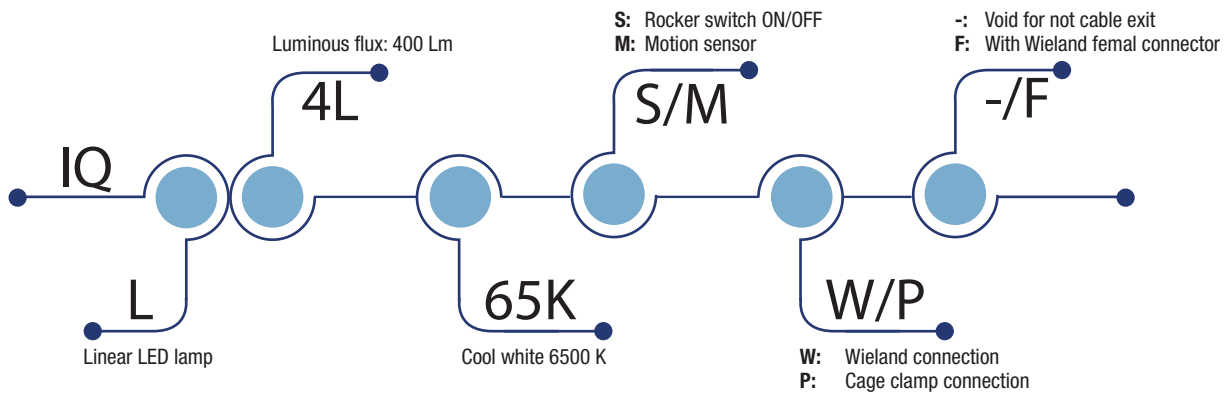

example: IQL4L65KMW

MAIN FEATURES

- 01 Universal use**
 - Wide voltage range 24V-265V AC/DC
- 02 Motion sensor**
 - Movement sensor with 5 minute setting
- 03 Rocker switch on/off**
- 04 Connection options**
 - Wieland plug or cage clamp connection
- 05 Push to release**
 - Applicable to every connection type
- 06 Mounting**
 - Integrated magnets or plastic clips (provided)
- 07 Daisy chain**
 - Max 16 lamps AC / max 8 lamps DC



Control Cabinet Devices

Linear LED Lamp - Summary

HIGH PERFORMANCE

- Light output 400Lm
- Protection degree IP20
- Operating range fro -30°C to +70°C
- Life time: 40000 hours
- Power consumption: 4W
- Wide voltage range 24V-265V AC/DC
- LED lamp type, 120° angle
- Light color: Cool white
- Temperature: 6500 K

Dimensions

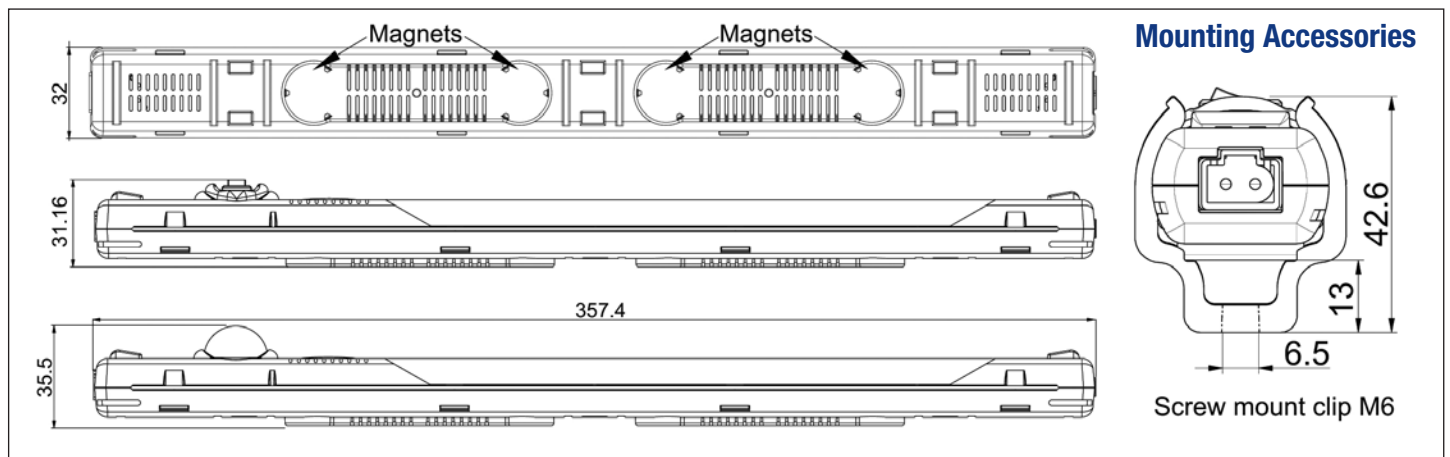

Mounting

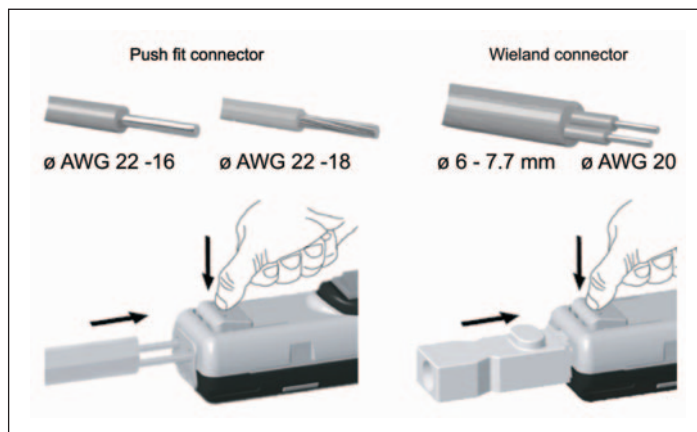

Light distribution curve

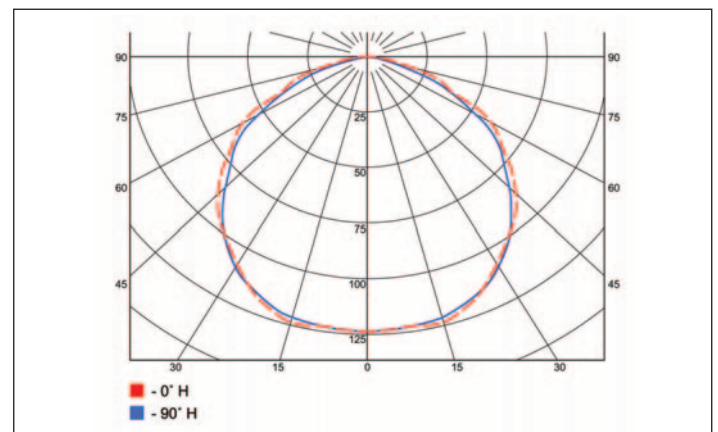

Control Cabinet Devices

Flashing Device

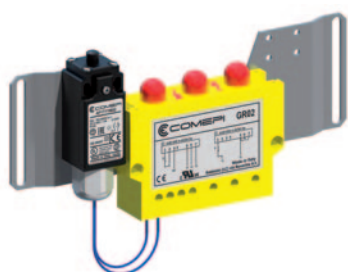
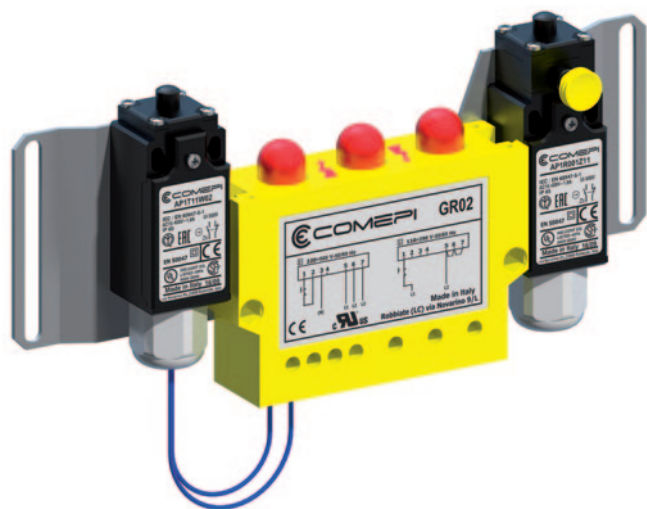

Main features and applications

GR02 flashing device, realized by Comepi, is designed to detect voltage presence inside an electrical panel in an easy and safe way, decreasing the risk of accidents thanks to the flashing lamps that are able to make evidence of a dangerous situation.

The modularity of the device allows to integrate the flashing device in useful systems during the electrical panel maintenance: lamps or fans are now installable in a safer way.

Description

Flashing device with fixing bracket (225mm fixing distance between centers), including AP1T10Z11 limit switch and AP1R001Z11 device with yellow door closing simulation device.

Device conform to IEC 60947-5-1 standard and approved according to UL 508.

Code
GR01

Supply Voltage:

3 ~ 220÷500V / 50÷60Hz

1 ~ 110÷290V / 50÷60Hz

Description

Flashing device with fixing bracket (225mm fixing distance between centers), including AP1T10Z11 limit switch.

Device conform to IEC 60947-5-1 standard and approved according to UL 508.

Code
GR03

Supply Voltage:

3 ~ 220÷500V / 50÷60Hz

1 ~ 110÷290V / 50÷60Hz

Description

Flashing device.

Device conform to IEC 60947-5-1 standard and approved according to UL 508.

Code
GR02

Supply Voltage:

3 ~ 220÷500V / 50÷60Hz

1 ~ 110÷290V / 50÷60Hz



Accessoires



Description

Limit switch fixing kit for metal profiles (screws included)

Code
GR2116

Accessoires



Description

Fixing bracket (225mm fixing distance between centers).

Code
GR-FX1

Limit switch fixing kit for AP series limit switches (50mm fixing distance between centers – Screws included).

Code
GR2117

DIN rail mounting bracket for flashing device.

Code
PPK02

Control Cabinet Devices

Limit Switches

AP•R001Z11 Series

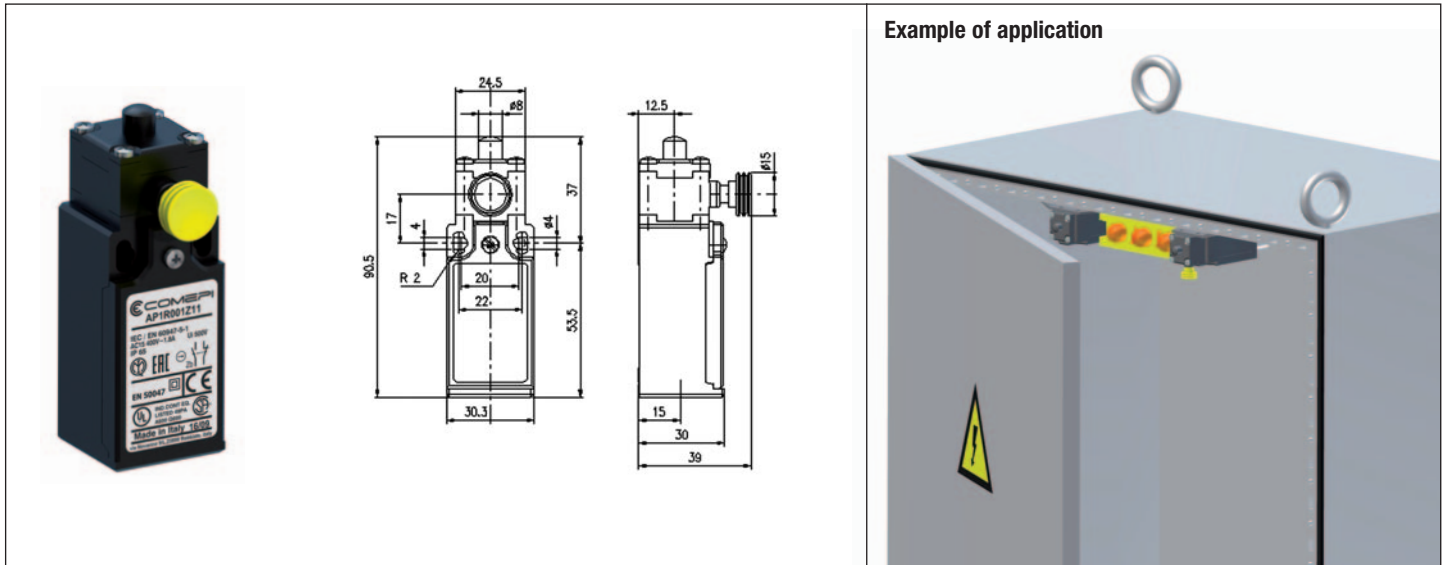

Description

This particular limit switch has been developed in order to fulfill all the requests coming from applications in which there is the necessity to simulate the change over in contacts position without acting directly, on the plunger of the switch. The use of this device is particularly useful in the realization of electrical boards in order to simulate the closing of the door simply by pushing the yellow button on the limit switch; the assigned staff will then be able to work on the internal circuit to make modifications, maintenance, etc... The conditions of normal operation are automatically restored once the door of the electric board is closed.

Z11	(1NO + 1NC)	AP•R001Z11
Z02	(2NC)	AP•R001Z02
W03P	(3NC)	AP•R001W03P

Standard Limit Switches

T10: nylon plunger

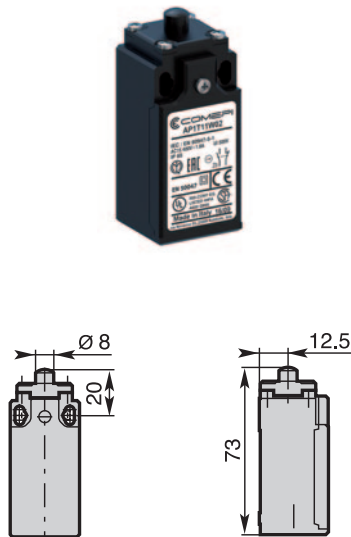

T14 - Metal plunger with dust protection cup

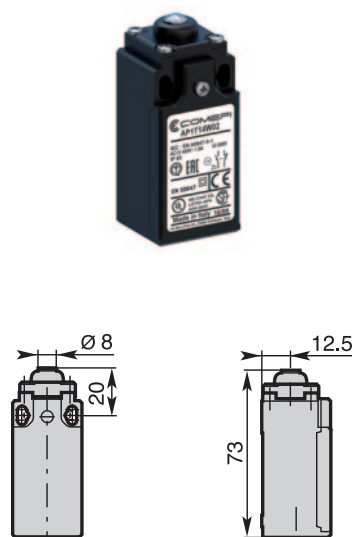

T30 - Plastic roller lever on plastic plunger

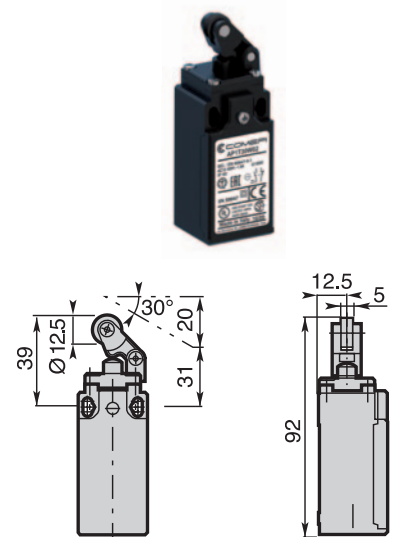

Limit Switches

Special applications

BP•U Series 40 mm. polymeric limit switches - IP 65 □ - EN 50041 - one cable inlet

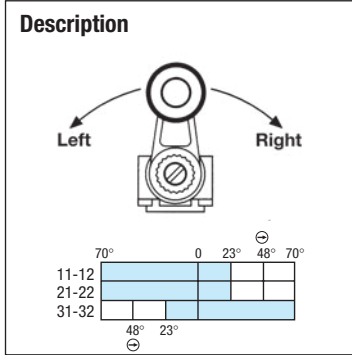

- The lever on the right open contacts 11-12 and 21-22
- The lever on the left open contacts 31-32
- Positive opening of the contacts on both the directions
- Other levers available

Cable inlets:

Replace the symbol • with the number of the required thread

- BP1:** PG 13.5
BP2: 1/2" NPT
BP5: M 20 x 1,5

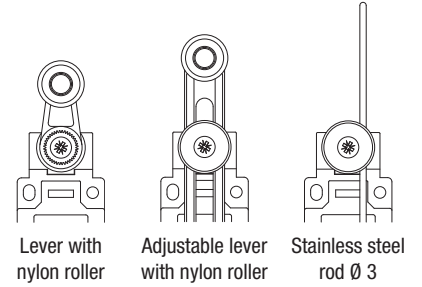

Contact elements

J03 (3NC)

U41	U51	U71
BP•U41J03	BP•U51J03	BP•U71J03

AP• Series 30 mm. polymeric limit switches - IP 65 □ - EN 50047 - one cable inlet

Cable inlet: Replace the symbol • with the number of the required thread

AP1: PG 13.5 **AP2:** 1/2" NPT (with adapter) **AP3:** PG 11 **AP4:** M 16 x 1,5 **AP5:** M 20 x 1,5

AP•V41J02 Series

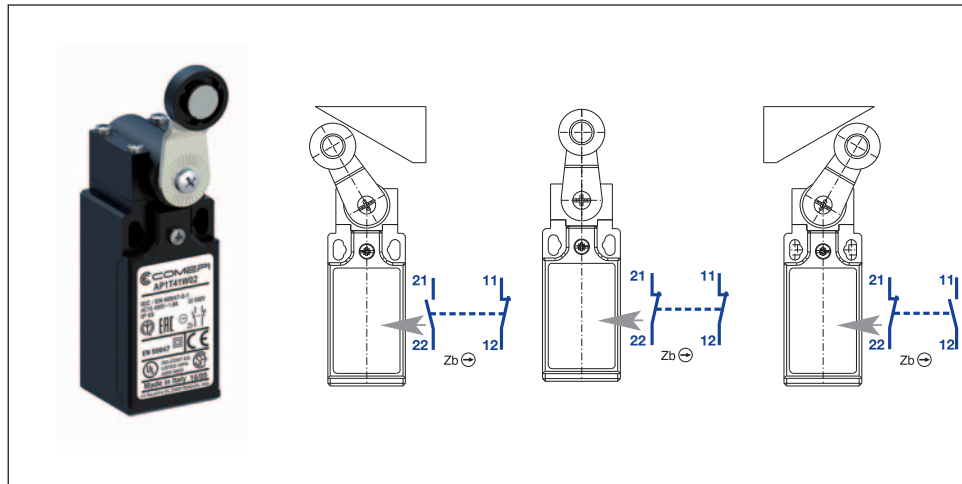

Description

The Switch is settled with 2NC contacts in free position.

The actuation of the lever causes the opening of the contact related to the actuating direction, leaving unchanged the status of the second contact. Both contacts have positive opening operation according to IEC/EN 60947-5-1 standards.

Limit Switches with M12 Connector

Special application

APPROVALS: UL 508 / CSA C22-2 N. 14

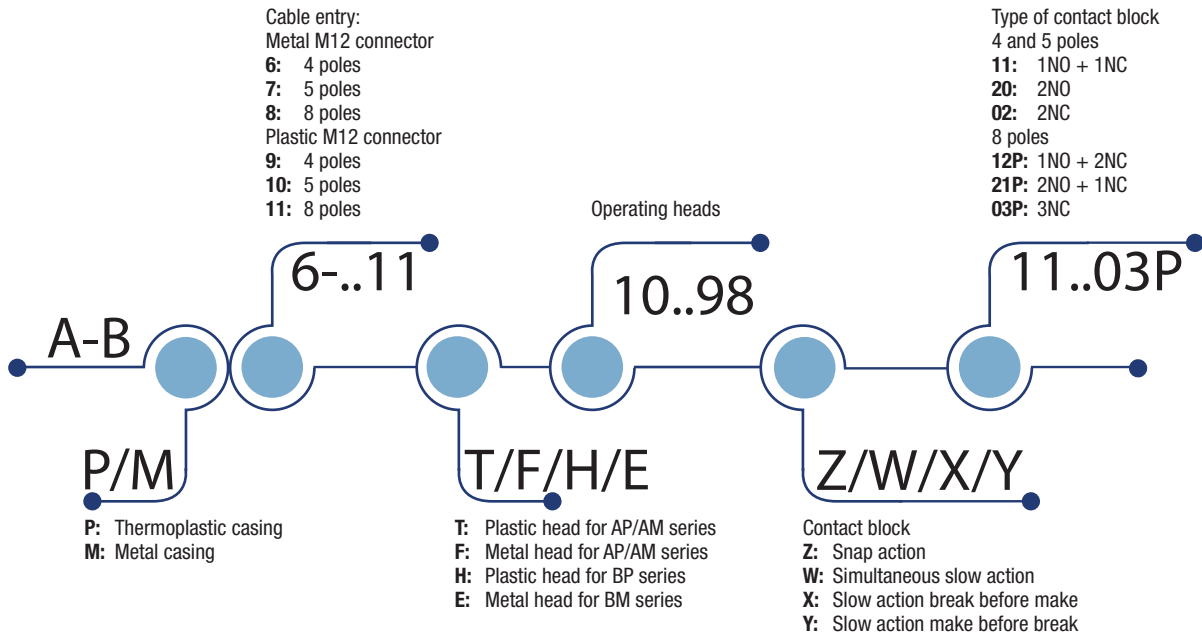

example: AM7F11Z11

The feasibility of a code number does not mean the effective actuability of a product. Please contact our sales office.

HOW IS IT MADE?

- 01 M12 Connector 4, 5 and 8 poles
- 02 Contact blocks
- 03 Casing
- 04 Operating head
- 05 Label

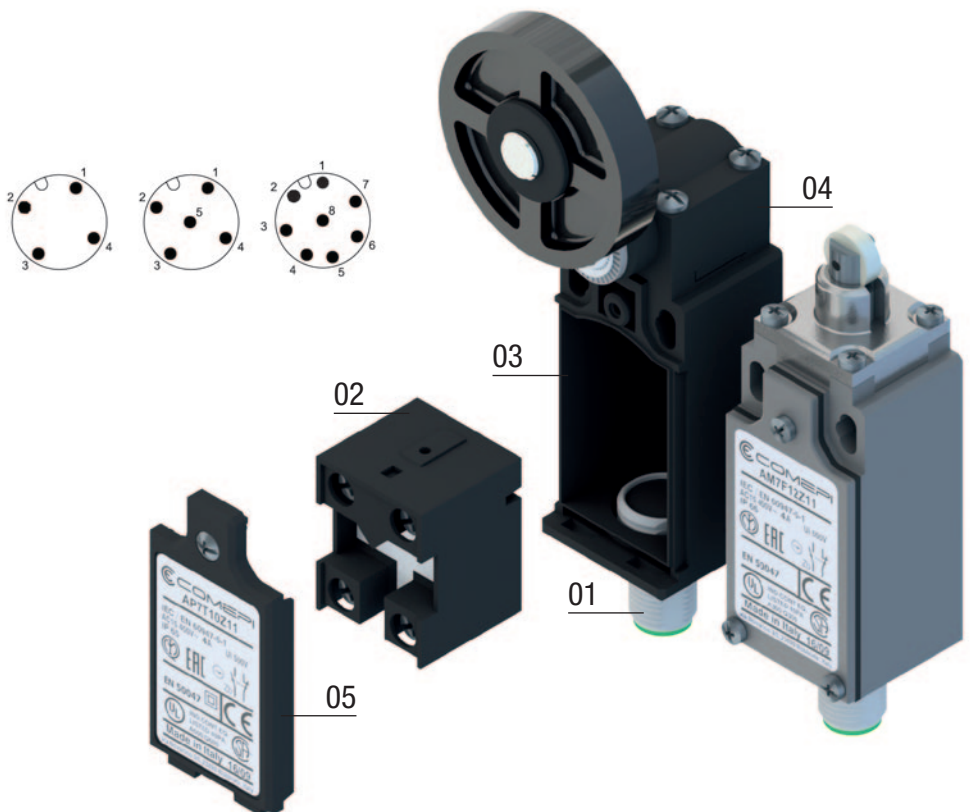

SIMPLE AND FUNCTIONAL

- Limit switch pre-wired with M12 connector 5/8 poles.
- Functionality and simplicity make this product ready to use.

Limit Switches with **M12 Connector**

Connection diagrams

4-5 POLES CONNECTOR

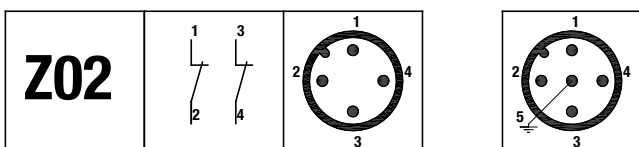
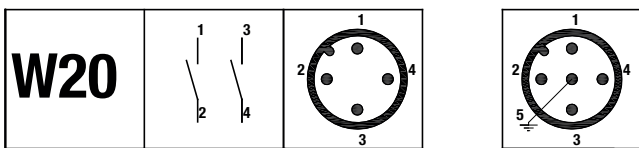
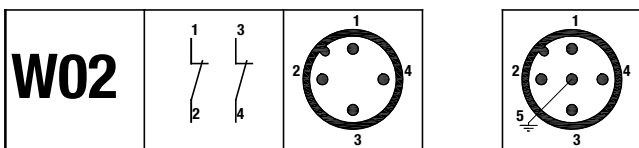
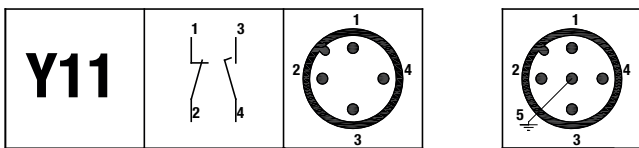
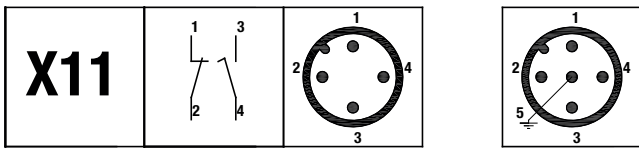
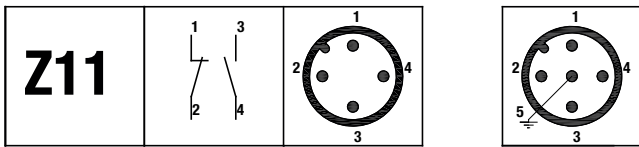

8 POLES CONNECTOR

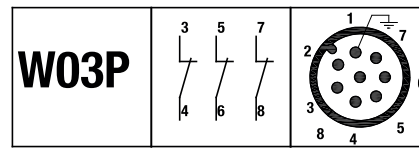
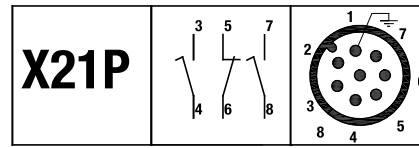
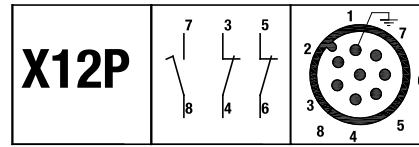

M12 Connector 4 poles

- 1 Brown
- 2 White
- 4 Black
- 3 Blue

M12 Connector 5 poles

- 1 Brown
- 2 White
- 4 Black
- 3 Blue
- 5 Gray

M12 Connector 8 poles

- 1 White
- 2 Brown
- 3 Green
- 4 Yellow
- 5 Gray
- 6 Pink
- 7 Blue
- 8 Red

Limit Switches with **Deutsch Connector**

Special application

APPROVALS: UL 508 / CSA C22-2 N. 14

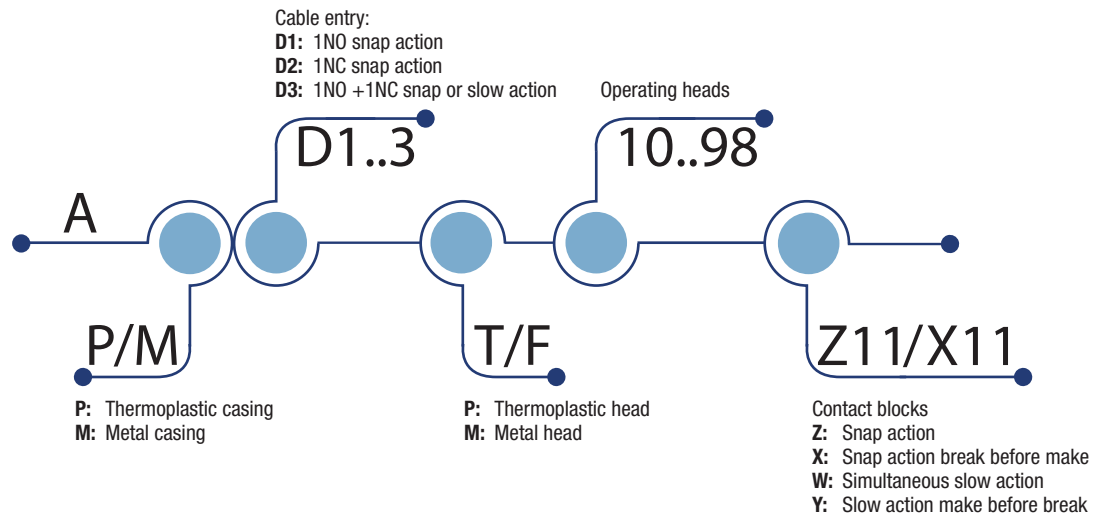

esempio: **AMD1F11Z11**

La fattibilità di un codice non esplicita l'effettiva attuabilità di un prodotto. Si prega di contattare il nostro ufficio vendite.

HOW IS IT MADE?

- 01** Deutsch connector
- 02** Contact blocks
- 03** Casing
- 04** Operating head
- 05** Label

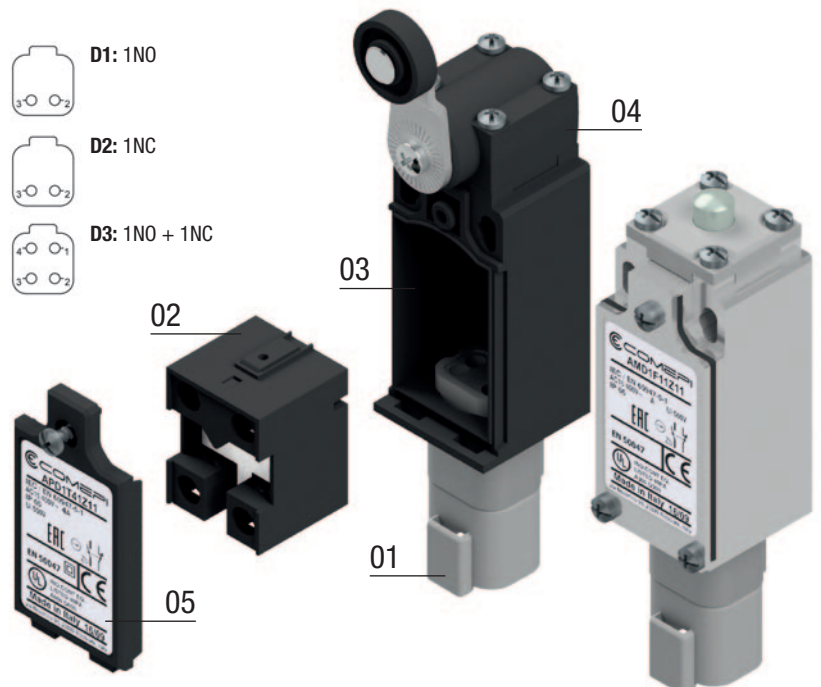

PRE-WIRED AND READY TO USE

- Pre-wired limit switch with connector integrated deutsch type DT04.
- Quick to install and suitable for harsh environmental use.
- Particularly suitable for automotive applications.

Limit Switches with **Deutsch Connector**

Connection diagrams

SNAP ACTION

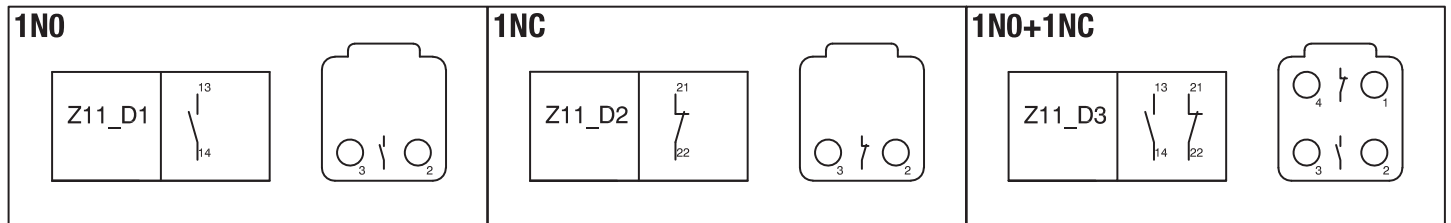

SNAP ACTION

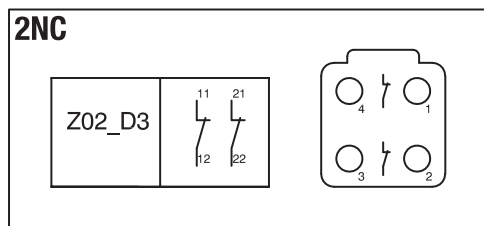

SNAP ACTION BREAK BEFORE MAKE

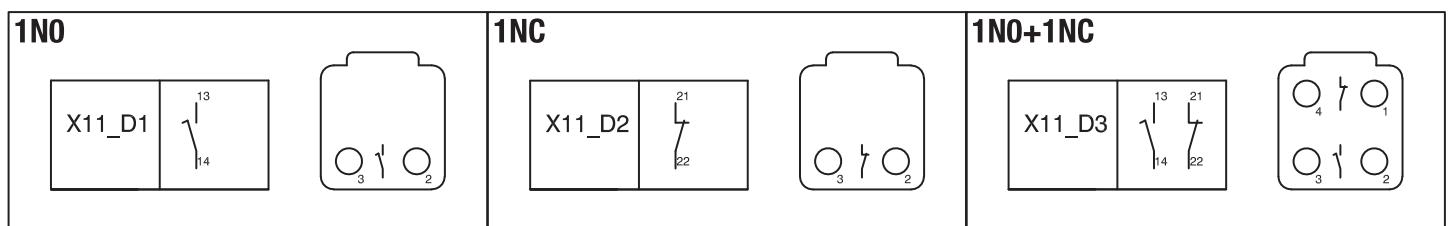

SIMULTANEOUS SLOW ACTION

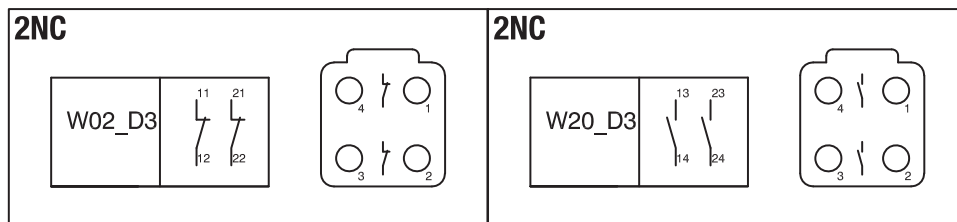

SLOW ACTION MAKE BEFORE BREAK

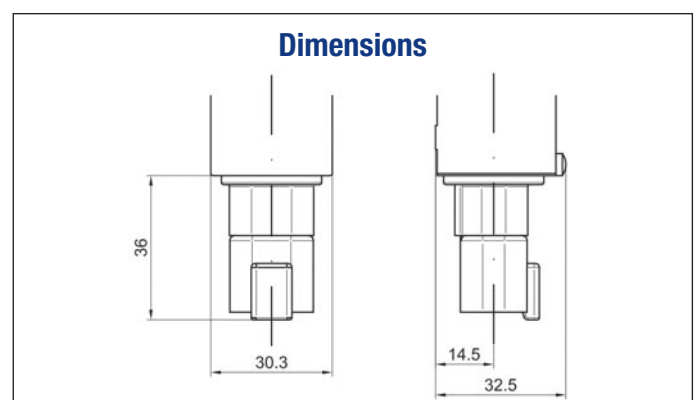
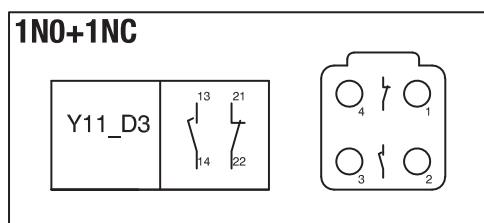

Limit Switches

Plastic and Metal casing - Accessories

Connectors

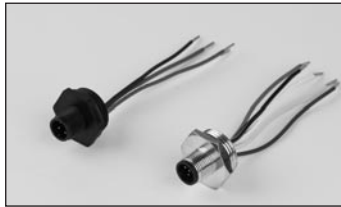

Code	Description
XX1085CO	4 poles metal connector M16-M12 - 4 conductors
XX1037CO	5 poles metal connector M16-M12 - 5 conductors
XX1068CO	8 poles metal connector M16-M12 - 8 conductors
GR XX1101CO	4 poles plastic connector M20-M12 - 4 conductors
GR XX1102CO	5 poles plastic connector M20-M12 - 5 conductors
GR XX1103CO	8 poles plastic connector M20-M12 - 8 conductors

Cables with M12 female connector



Code	Description
XX4D030SM	4 poles PVC cable - 3m with M12 straight connector
XX4D050SM	4 poles PVC cable - 5m with M12 straight connector
XX5D030SM	5 poles PVC cable - 3m with M12 straight connector
XX5D050SM	5 poles PVC cable - 5m with M12 straight connector
XX8D050SM	8 poles PVC cable - 5m with M12 straight connector
XX8D030SM	8 poles PVC cable - 3m with M12 straight connector
XX4A030SM	4 poles PVC cable - 3m with M12 90° connector
XX4A050SM	4 poles PVC cable - 5m with M12 90° connector
XX5A030SM	5 poles PVC cable - 3m with M12 90° connector
XX5A050SM	5 poles PVC cable - 5m with M12 90° connector
XX8A030SM	8 poles PVC cable - 3m with M12 90° connector
XX8A050SM	8 poles PVC cable - 5m with M12 90° connector

Accessories for electric panel



Code	Description
GR2116	Fixing kit including screws

Accessories for electric panel



Code	Description
GR2117	50mm pitch fixing kit for AP series limit switches

Spacers

This accessory, made of polymer glass-reinforced resin, allows the lever to operate with a different offset.

Image	Order Code	Compatible Heads
	GR1531	T41 ÷ T46 F41 ÷ F46 G41 ÷ G45

Image	Order Code	Compatible Heads
	GR1532PI	T51 ÷ T75 F51 ÷ F75 G51 ÷ G75

Cable glands - Blanking plugs - Thread adapters

The use of correct cable gland (or blanking plug in case of unused cable inlets) is recommended if the product is installed in an environmental place in which a protection degree against water or dust is needed. Comepi's cable glands and blanking plugs are realized to guarantee protection degree of IP 66. Thread adapters are available in order to reach the customers' request. The adapters must always be used in case a conduit connection directly on the limit switch is needed. Different adapters can be supplied upon request.

	Order Code	Description	Dimensions					
			A	B	C	D	E	F
Cable Gland 	XX 1041 CO	PG 13.5 Plastic Cable Gland	24	-	PG 13.5	10	24-29	ø 6-12
	XX 1028 PE	PG 11 Plastic Cable Gland	22	-	PG 11	10	23-28	ø 5-10
	XX 1032 CO	M 16 x 1,5 Plastic Cable Gland	19	-	M 16 x 1,5	8	23-28	ø 7-10
	XX 1033 CO	M20 x 1,5 Plastic Cable Gland	25	-	M 20 x 1,5	9	24-29	ø 8-13
	XX 1020 CO	PG 16 Plastic Cable Gland	27	-	PG 16	10	26-31	ø 10-14
Blanking Plug 	PL 2029 PI	PG 13.5 Plastic Blanking Plug	25	PG 13.5	6	3.5	-	-
	XT 007	PG 11 Plastic Blanking Plug	22	PG 11	6	3	-	-
	XX 1030 CO	M 16 x 1,5 Plastic Blanking Plug	20	M 16 x 1,5	6	3	-	-
	XX 1031 CO	M 20 x 1,5 Plastic Blanking Plug	24	M 20 x 1,5	6	3,5	-	-
Thread Adapters 	GR 2000	PG 11 1/2" NPT Plastic Adapter	24	26	1/2" NPT	17	8	PG 11
	GR 2000 M	Brass Intermediary Connection						
		1/2" NPT - 1/2" NPT	24	26	1/2" NPT	17	6	1/2" NPT

Limit Switches

Specifications, Directives and Standards

The **Comepi** products listed in this catalogue are developed and manufactured according to the rules set out in IEC international publications and EN European standard.

Specifications

• International Specifications

The International Electrotechnical Commission, IEC, which is part of the International Standards Organization, ISO, publishes IEC publications which act as a basis for the world market.

• European Specifications

The European Committee for Electrotechnical Standardisation (CENELEC) publishes EN standards for low voltage industrial apparatus.

These European standards differ very little from IEC international standards and use a similar numbering system. The same is true of national standards. Contradicting national standards are withdrawn.

• Harmonised European Specifications

The European Committees for Standardisation (CEN and CENELEC) publish EN standards relating to safety of machinery.

• Specifications in Canada and the USA

These are equivalent, but differ markedly from IEC, UTE, VDE and BS specifications.

UL Underwriters Laboratories (USA)

CSA Canadian Standards Association (Canada)

Remark concerning the label issued by the UL (USA). Two levels of acceptance between devices must be distinguished.

“Recognized” Authorised to be included in equipment, if the equipment in question has been entirely mounted and wired by qualified personnel. They are not valid for use as “General purpose products” as their possibilities are limited.

They bear the mark: 

“Listed” Authorised to be included in equipment and for separate sale are “General purpose products” components in the USA.

They bear the mark: 

European Directives

The guarantee of free movement of goods within the European Community assumes elimination of any regulatory differences between the member states. European Directives set up common rules that are included in the legislation of each state while contradictory regulations are cancelled.

There are three main directives:

• Low Voltage Directive 2014/35/UE concerning electrical equipment from 50 to 1000 V a.c. and from 75 to 1500 V d.c.

This specifies that compliance with the requirements that is sets out **is acquired** once the equipment conforms to the standards harmonised at European level: EN 60947-1 and EN-60947-5-1 for **limit switches**.

• Machines Directives - 2006/42/CE defining main safety and health requirements concerning design and manufacture of the machines and other equipment including safety components in European Union countries.

• Electromagnetic Compatibility Directive 2014/30/UE concerning all electrical devices likely to create electromagnetic disturbances.

Signification of CE marking:

CE marking must not be confused with a quality label.

CE marking placed on a product is proof of conformity with the European Devices concerning the product.

CE marking is part of an administrative procedure and guarantees free movement of the product within the European Community.

Standards

• International Standards

IEC 60947-1 Low-voltage switchgear and controlgear - Part 1: General Rules (CEI EN 60947-1).

IEC 60947-5-1 Low-voltage switchgear and controlgear - Part 5: Control circuit devices and switching elements - Section 1: Electromechanical control circuit devices (CEI EN 60947-5-1) - Chapter 3: Special requirements for control switches with positive opening operation.

IEC 60204-1 Electrical equipment on industrial machines - Part 1: General requirements (CEI EN 60204-1).

IEC 60204-2 Electrical equipment on industrial machines - Part 2: Item designation and examples of drawings, diagrams, tables and instructions.

IEC 60529 Degrees of protection provided by enclosure (IP code) (CEI EN 60529).

Limit Switches

Specifications, Directives and Standards

- **European Standards**

- EN 50041** Low-voltage switchgear and controlgear for industrial use - Control switches - Position switches 42,5 x 80 - Dimensions and characteristics.
- EN 50047** Low-voltage switchgear and controlgear for industrial use - Control switches - Position switches 30 x 55 - Dimensions and characteristics.
- EN 60947-1** Low-voltage switchgear and controlgear for industrial use - Part 1: General rules.
- EN 60947-5-1** Low-voltage switchgear and controlgear for industrial use - Part 5: Control circuit devices and switching elements - Section 1: Electromechanical control circuit devices - Chapter 3: Special requirements for control switches with positive opening operation.
- EN 60529** Degrees of protection provided by enclosures (IP code).
- EN 61058-1** Switches for appliances. Part. 1: general requirements.
- EN 60947-5-5** Low-voltage switchgear and controlgear - Part 5-5: Control circuit devices and switching elements - Electrical emergency stop device with mechanical latching function.

- **American Standards**

- UL 508** Standard for Industrial Control Equipment.
- CSA - C22.2 No. 14-13** Industrial Control Equipment.

- **China Standards**

- GB/T14048.5** Low-voltage switchgear and controlgear - Part 5-1: Control circuit devices and switching element - Electromechanical control circuit devices.

Limit Switches

Plastic or Metal Casing - Terminology

Double Insulation

Class II materials, according to IEC 536, are designed with double insulation. This measure consists in doubling the functional insulation with an additional layer of insulation so as to eliminate the risk of electric shock and thus not having to protect elsewhere. No conductive part of "double insulated" material should be connected to a protective conductor.

Positive Opening Operation

A control switch, with one or more break-contact elements, has a positive opening operation when the switch actuator ensures full contact opening of the break-contact. For the part of travel that separates the contacts, there must be a positive drive, with no resilient member (e.g. springs), between the moving contacts and the point of the actuator to which the actuating force is applied.

The positive opening operation does not deal with N.O. contacts.

Control switches with positive opening operation may be provided with either snap action or slow action contact elements. To use several contacts on the same control switch with positive opening operation, they must be electrically separated from each other, if not, only one may be used.

Every control switch with positive opening operation must be indelibly marked on the outside with the symbol:  .

Snap Action

Snap action contacts are characterised by a release position that is distinct from the operating position (differential travel). Snap breaking of moving contacts is independent of the switch actuator's speed and contributes to regular electric performance even for slow switch actuator speeds.

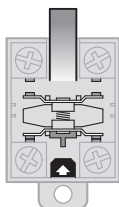

State of rest

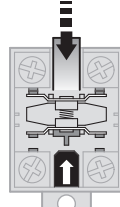

Contact change

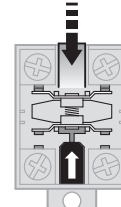

Positive opening

Slow Action

Slow action contacts are characterised by a release position that is the same as the operating position. The switch actuator's speed directly conditions the travel speed of contacts.

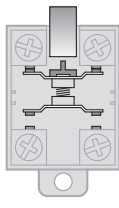

State of rest

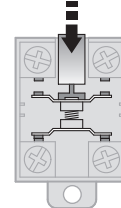

Completely closed

Contact shape according to IEC 947-5-1.

Change-over contact elements with 4 terminals must be indelibly marked with the corresponding Za or Zb symbol as in the diagrams below.



Contacts with the same polarity

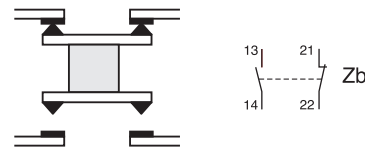

The 2 moving contacts are electrically separated

Utilization Category

AC-15: switching of electromagnetic loads of electromagnets using an alternating current (>72 VA).

DC-13: switching of electromagnets using a direct current.

Terminals

Limit switches with metal casings must have a terminal, for a protective conductor, that is placed inside the casing very close to the cable inlet and must be indelibly marked.

Minimum Actuation Force/Torque

The minimum amount of force/torque that is to be applied to the switch actuator to produce a change in contact position.

Minimum Force/Torque to achieve Positive Opening Operation

The minimum amount of force/torque that is to be applied to the switch actuator to ensure positive opening operation of the N.C. contact.

Limit Switches

Utilization Precautions

Plain Plunger

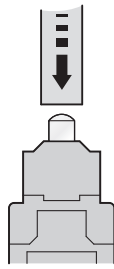

Correct

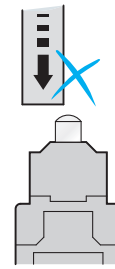

Incorrect

Roller Plunger or Roller Lever

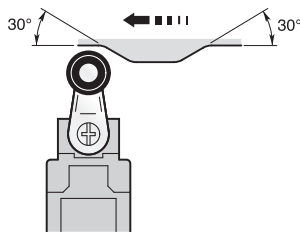

Correct

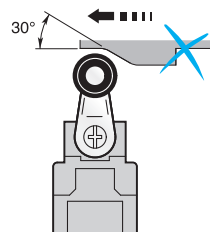

Incorrect

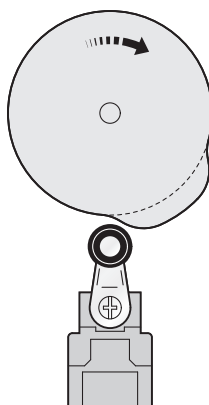
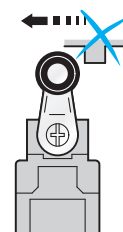

Correct

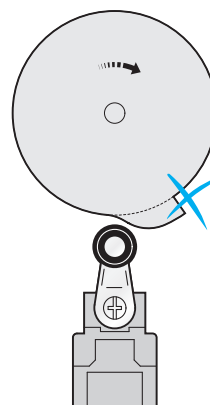

Incorrect

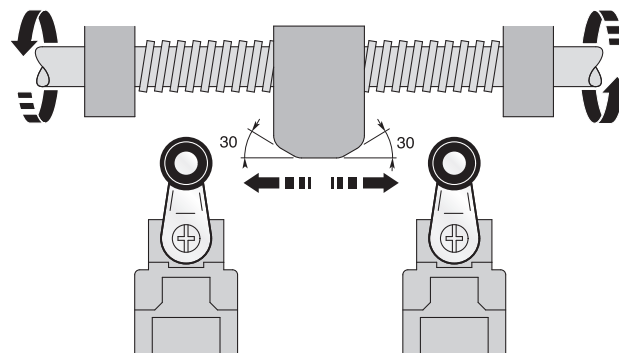
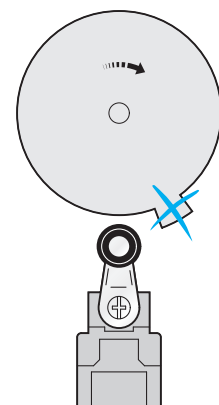

For a relatively slow movement of the switch actuator, a limit switch with a snap action contact block is preferred.

Limit Switches

Plastic or Metal Casing - Travel and Operation Diagrams

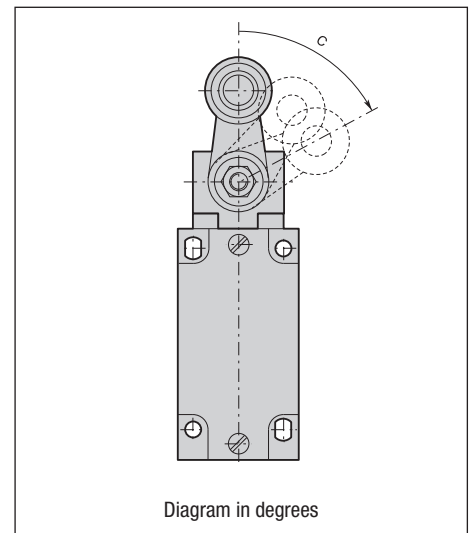
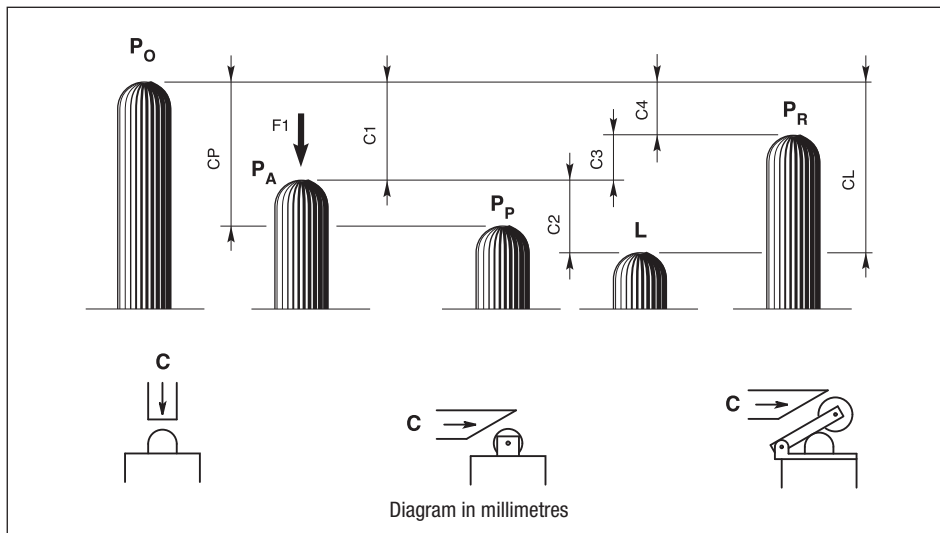

P₀ Free position:

position of the switch actuator when no external force is exerted on it.

P_A Operating position:

position of the switch actuator, under the effect of force F₁, when the contacts leave their initial free position.

P_P Positive opening position:

position of the switch actuator from which positive opening is ensured.

L Max. travel position:

maximum acceptable travel position of the switch actuator under the effect of a force F₁.

P_R Release position:

position of the switch actuator when the contacts return to their initial free position.

C₁ Pre-travel:

distance between the free position P₀ and the operating position P_A.

C_P Positive opening travel:

minimum travel of the switch actuator, from the free position, to ensure positive opening operation of the normally closed contact.

C₂ Over-travel:

distance between the operating position P_A and the max. travel position L.

C_L Max. travel:

distance between the free position P₀ and the max. travel position L.

C₃ Differential travel (C₁-C₄):

travel difference of the switch actuator between the operating position P_A and the release position P_R.

C₄ Release travel:

distance between the release position P_R and the free position P₀.

Diagram for snap action contacts:

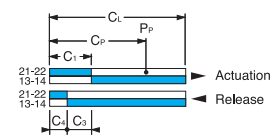
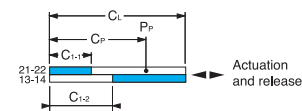

Diagram for non-overlapping slow action contacts:



Note: for slow action contacts, C₃ = 0, C₁₋₁ = pre-travel of contact 21-22, C₁₋₂ = pre-travel of contact 13-14

Examples:

BM1E13Z11

(snap action contacts)

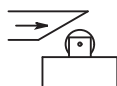
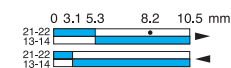

Diagram in millimetres/cam travel



BM1E41Z11

(snap action contacts)

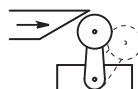
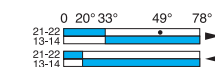

Diagram in degrees/lever rotation



BM1E11X11

(non-overlapping slow action contacts)





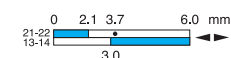

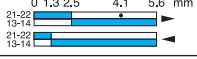

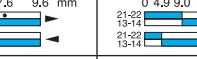

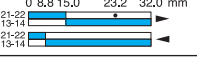



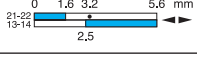

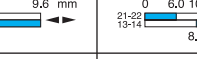

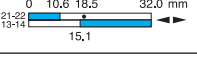



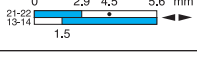

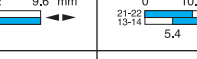



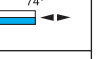



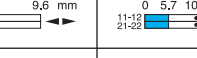

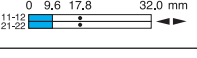





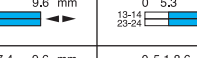



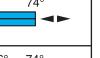

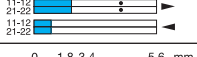

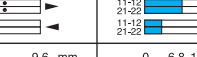

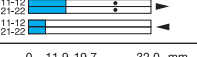



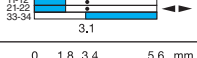

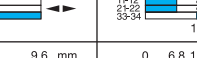



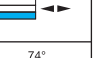

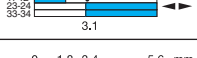

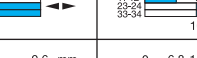

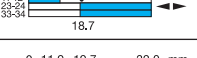



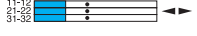



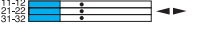









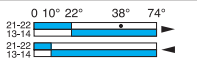



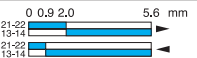

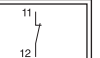

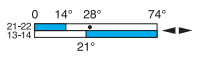



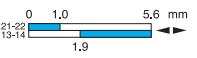

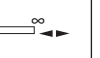

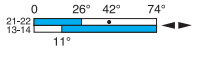



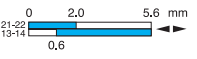



















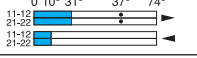







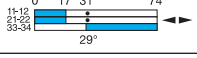

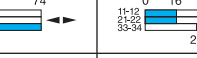





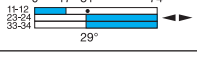

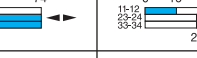





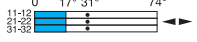





Diagram in millimetres/plunger travel



Limit Switches AP/DP/AM/DM series











Diagrams

					
Operating head types	T10 - T11 - T14 T21 - T2101 - F11	T12 - T13 - F12	T30 - T31 - T32 T34 - T35 - T36	T38 - T39	T41+46 T51+55 T5100+5500 T71+75 F41+46 F51+55 F5100+5500 F71+75
Max actuation speed [m/s]	0,5	0,3	1,0	1,0	1,5
Z11 SNAP ACTION (1NO + 1NC)	 	 	 	 	
X11 SLOW ACTION (1NO + 1NC)	 	 	 	 	
Y11 SLOW ACTION (1NO + 1NC)	 	 	 	 	
W02 SLOW ACTION (2NC)	 	 	 	 	
W20 SLOW ACTION (2NO)	 	 	 	 	
Z02 SNAP ACTION (2NC)	 	 	 	 	
X12P SLOW ACTION (1NO + 2NC)	 	 	 	 	
X21P SLOW ACTION (2NO + 1NC)	 	 	 	 	
W03P SLOW ACTION (3NC)	 	 	 	 	

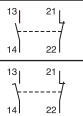
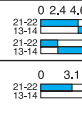
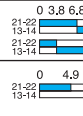
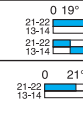
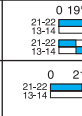
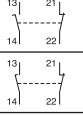
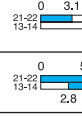
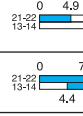
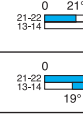
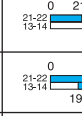
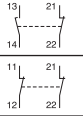
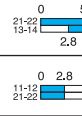
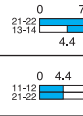
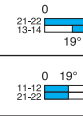
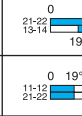
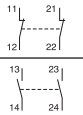
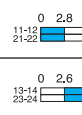
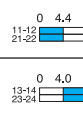
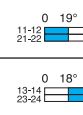
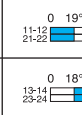
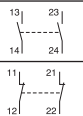
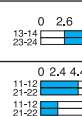
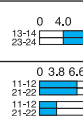
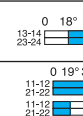
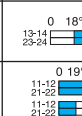
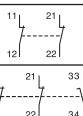
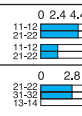
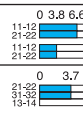
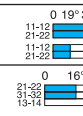
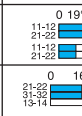
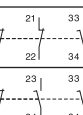
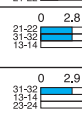
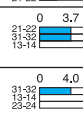
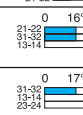
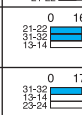
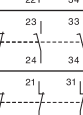
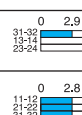
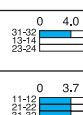
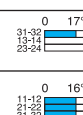
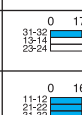
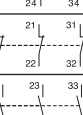
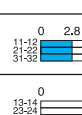
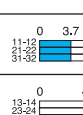
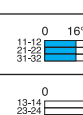
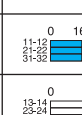



					
Operating head types	T48	T61 - T62 F61 - F62	T91 - T92 - T93	T98	T80
Max actuation speed [m/s]	1,5	1,5	1,0	0,5	0,5
Z11 SNAP ACTION (1NO + 1NC)	 	 	 	 	J01 SLOW ACTION (1NC) 
X11 SLOW ACTION (1NO + 1NC)	 	 	 	 	
Y11 SLOW ACTION (1NO + 1NC)	 	 	 	 	
W02 SLOW ACTION (2NC)	 	 	 	 	
W20 SLOW ACTION (2NO)	 	 	 	 	
Z02 SNAP ACTION (2NC)	 	 	 	 	
X12P SLOW ACTION (1NO + 2NC)	 	 	 	 	
X21P SLOW ACTION (2NO + 1NC)	 	 	 	 	
W03P SLOW ACTION (3NC)	 	 	 	 	

Limit Switches BP series

Diagrams

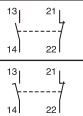
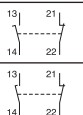
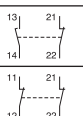
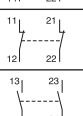

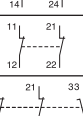
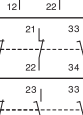
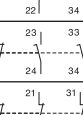
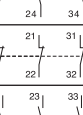

					
Operating head types	H11 - H12 - H14	H13 - H19	H31 - H32 - H33	H41÷44 H51÷54 H71÷74	H61 - H62
Max actuation speed [m/s]	0,5	0,5	1,0	1,5	1,8
Z11 SNAP ACTION (1NO + 1NC)	 0 1,0 2,2 3,8 5,9 mm	 0 2,4 4,6 7,5 10,5 mm	 0 3,8 6,8 11,3 17,0 mm	 0 19° 31° 47° 90°	 0 19° 31° 90°
X11 SLOW ACTION (1NO + 1NC)	 0 1,3 2,9 5,9 mm	 0 3,1 6,0 10,5 mm	 0 4,9 9,4 17,0 mm	 0 21° 37° 90°	 0 21° 90°
Y11 SLOW ACTION (1NO + 1NC)	 0 2,4 4,0 5,9 mm	 0 5,1 8,0 10,5 mm	 0 7,6 12,1 17,0 mm	 0 34° 50° 90°	 0 34° 90°
W02 SLOW ACTION (2NC)	 0 1,1 2,7 5,9 mm	 0 2,8 5,7 10,5 mm	 0 4,4 8,9 17,0 mm	 0 19° 35° 90°	 0 19° 90°
W20 SLOW ACTION (2NO)	 0 1,0 5,9 mm	 0 2,6 10,5 mm	 0 4,0 17,0 mm	 0 18° 90°	 0 18° 90°
Z02 SNAP ACTION (2NC)	 0 1,0 2,0 3,6 5,9 mm	 0 2,4 4,4 7,3 10,5 mm	 0 3,8 6,6 11,1 17,0 mm	 0 19° 30° 46° 90°	 0 19° 30° 90°
X12 SLOW ACTION (1NO + 2NC)	 0 0,9 2,4 5,9 mm	 0 2,8 5,3 10,5 mm	 0 3,7 7,5 17,0 mm	 0 16° 33° 90°	 0 16° 90°
X21 SLOW ACTION (2NO + 1NC)	 0 1,0 2,5 5,9 mm	 0 2,9 5,4 10,5 mm	 0 4,0 7,6 17,0 mm	 0 17° 34° 90°	 0 17° 90°
W03 SLOW ACTION (3NC)	 0 0,9 2,4 5,9 mm	 0 2,8 5,3 10,5 mm	 0 3,7 7,5 17,0 mm	 0 16° 33° 90°	 0 16° 90°
W30 SLOW ACTION (NO)	 0 1,3 5,9 mm	 0 3,3 10,5 mm	 0 4,8 17,0 mm	 0 21° 90°	 0 21° 90°







Operating head types	H91 - H92 - H93
Max actuation speed [m/s]	1,0
Z11 SNAP ACTION (1NO + 1NC)	 0 15° 27°
X11 SLOW ACTION (1NO + 1NC)	 0 18° 25°
Y11 SLOW ACTION (1NO + 1NC)	 0 30° 17°
W02 SLOW ACTION (2NC)	 0 17°
W20 SLOW ACTION (2NO)	 0 16°
Z02 SNAP ACTION (2NC)	 0 15° 26°
X12 SLOW ACTION (1NO + 2NC)	 0 15° 32°
X21 SLOW ACTION (2NO + 1NC)	 0 16° 32°
W03 SLOW ACTION (3NC)	 0 15°
W30 SLOW ACTION (NO)	 0 19°

Limit Switches **BM/CM** series













































Diagrams















					
Operating head types	E11 - E12 P11 - M14	E13 M13 - M19	E21	E22 - E23	E31 - E32 - E33
Max actuation speed [m/s]	0,5	0,5	0,5	0,5	1,5
Z11 SNAP ACTION (1NO + 1NC)					
X11 SLOW ACTION (1NO + 1NC)					
Y11 SLOW ACTION (1NO + 1NC)					
W02 SLOW ACTION (2NC)					
W20 SLOW ACTION (2NO)					
Z02 SNAP ACTION (2NC)					
X12 SLOW ACTION (1NO + 2NC)					
X21 SLOW ACTION (2NO + 1NC)					
W03 SLOW ACTION (3NC)					
W30 SLOW ACTION (NO)					

				
Operating head types	E41÷44 E51÷54 E71÷74 M41÷44 M51÷54 M71÷74	E61 - E62 M61 - M62	E91 - E92 - E93 P91 - P92 - P93	E99
Max actuation speed [m/s]	1,5	1,5	1,0	0,5
Z11 SNAP ACTION (1NO + 1NC)				
X11 SLOW ACTION (1NO + 1NC)				
Y11 SLOW ACTION (1NO + 1NC)				
W02 SLOW ACTION (2NC)				
W20 SLOW ACTION (2NO)				
Z02 SNAP ACTION (2NC)				
X12 SLOW ACTION (1NO + 2NC)				
X21 SLOW ACTION (2NO + 1NC)				
W03 SLOW ACTION (3NC)				
W30 SLOW ACTION (NO)				

Limit Switches EP series















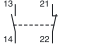



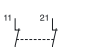
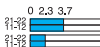



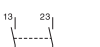



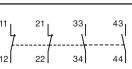
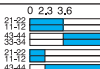



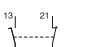
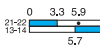



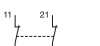

Diagrams

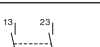
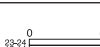



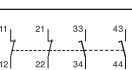
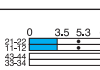









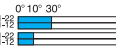
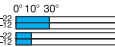
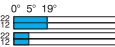

	 Actuator with end plunger	 Actuator with end roller plunger	 Actuator with roller lever for 1 direction	 Actuator with adjustable roller lever	 Actuator with roller/rod lever
Operating head types	G11 - G16 - G21	G12 - G15 - G17 G22 - G25	G31 - G32	G38	G41÷53 G71÷75
Max actuation speed [m/s]	0,5	0,1	1,0	1,0	1,5
Z SNAP ACTION 1NO+1NC	 0 1,4 2,2 4,3 5,0 mm	 0 2,4 3,8 7,5 8,7 mm	 0 5,9 8,5 14,0 19,0 mm	 0 8,9 12,9 21,0 29,0 mm	 0 21° 32° 65° 74°
Z2 SNAP ACTION 2NC	 0 1,3 2,1 4 5,0 mm	 0 2,3 3,7 7 8,7 mm	 0 5,9 8,5 14 19,0mm	 0 7,6 12,2 23,3 29,0mm	 0° 10° 30° 55° 74°
Z3 SNAP ACTION 2NO	 0 1,3 2,1 5,0 mm	 0 2,3 3,7 8,7 mm	 0 5,9 8,5 19,0mm	 0 7,6 12,2 29,0mm	 0° 10° 30° 74°
Z4 SNAP ACTION 2NO+2NC	 0 1,3 2,1 4 5,0 mm	 0 2,3 3,6 7 8,7 mm	 0 5 8 15,3 19,0mm	 0 7,6 12,2 23,3 29,0mm	 0° 10° 30° 55° 74°
X SLOW ACTION BREAK BEFORE MAKE 1NO+1NC	 0 1,9 3,4 5,0 mm	 0 3,3 5,9 8,7 mm	 0 6,9 12,4 19,0 mm	 0 9,6 18,5 29,0 mm	 0 28° 50° 74° 48°
X2 SLOW ACTION BREAK BEFORE MAKE 2NC	 0 2 3 5,0 mm	 0 3,5 5,3 8,7 mm	 0 7,6 11,4 19,0mm	 0 11,6 17,4 29,0mm	 0° 26° 39° 74°
X3 SLOW ACTION BREAK BEFORE MAKE 2NO	 0 3,5 5,0 mm	 0 6,2 8,7 mm	 0 13,3 19,0mm	 0 20,3 29,0mm	 0° 46° 74°
X4 SLOW ACTION BREAK BEFORE MAKE 2NC+2NO	 0 2 3 3,5 5,0 mm	 0 3,5 5,3 6,2 8,7 mm	 0 7,6 11,4 13,3 19,0mm	 0 11,6 17,4 20,3 29,0mm	 0° 26° 46° 74°

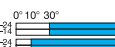
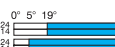
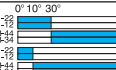
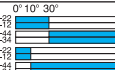
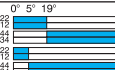
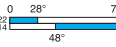
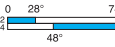
	 Actuator with steel spring	 Actuator with multidirectional spring
Operating head types	G61 - G62	G91 - G93
Max actuation speed [m/s]	1,5	1,0
Z SNAP ACTION 1NO+1NC	 0 21° 32° 74°	 0 10° 20°
Z2 SNAP ACTION 2NC	 0° 10° 30° 74°	 0° 5° 19°
Z3 SNAP ACTION 2NO	 0° 10° 30° 74°	 0° 5° 19°
Z4 SNAP ACTION 2NO+2NC	 0° 10° 30° 74°	 0° 5° 19°
X SLOW ACTION BREAK BEFORE MAKE 1NO+1NC	 0 28° 74° 48°	
X2 SLOW ACTION BREAK BEFORE MAKE 2NC	 0° 26° 74°	
X3 SLOW ACTION BREAK BEFORE MAKE 2NO	 0° 46° 74°	
X4 SLOW ACTION BREAK BEFORE MAKE 2NC+2NO	 0° 26° 46° 74°	

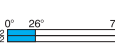
Limit Switches EM series

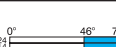
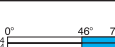
Diagrams

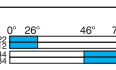
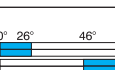
					
Operating head types	G11 - G16 - G21	G12 - G15 - G17 G22 - G25	G18	G31 - G32	G38
Max actuation speed [m/s]	0,5	0,1	0,5	1,0	1,0
Z SNAP ACTION 1NO+1NC	 0 1,4 2,2 4,3 5,0 mm	 0 2,4 3,8 7,5 8,7 mm	 0 2,4 3,8 7,5 8,7 mm	 0 5,9 8,5 14,0 19,0 mm	 0 8,9 12,9 21,0 29,0 mm
Z2 SNAP ACTION 2NC	 0 1,3 2,1 4 5,0 mm	 0 2,3 3,7 7 8,7 mm	 0 2,3 3,7 7 8,7 mm	 0 5,9 8,5 14 19,0 mm	 0 7,6 12,2 23,3 29,0 mm
Z3 SNAP ACTION 2NO	 0 1,3 2,1 5,0 mm	 0 2,3 3,7 8,7 mm	 0 2,3 3,7 8,7 mm	 0 5,9 8,5 19,0 mm	 0 7,6 12,2 29,0 mm
Z4 SNAP ACTION 2NO+2NC	 0 1,3 2,1 4 5,0 mm	 0 2,3 3,6 7 8,7 mm	 0 2,3 3,6 7 8,7 mm	 0 5 8 15,3 19,0 mm	 0 7,6 12,2 23,3 29,0 mm
X SLOW ACTION BREAK BEFORE MAKE 1NO+1NC	 0 1,9 3,4 5,0 mm	 0 3,3 5,9 8,7 mm	 0 3,3 5,9 8,7 mm	 0 6,9 12,4 19,0 mm	 0 9,6 18,5 29,0 mm
X2 SLOW ACTION BREAK BEFORE MAKE 2NC	 0 2 3 5,0 mm	 0 3,5 5,3 8,7 mm	 0 3,5 5,3 8,7 mm	 0 7,6 11,4 19,0 mm	 0 11,6 17,4 29,0 mm
X3 SLOW ACTION BREAK BEFORE MAKE 2NO	 0 3,5 5,0 mm	 0 6,2 8,7 mm	 0 6,2 8,7 mm	 0 13,3 19,0 mm	 0 20,3 29,0 mm
X4 SLOW ACTION BREAK BEFORE MAKE 2NC+2NO	 0 2 3 3,5 5,0 mm	 0 3,5 5,3 6,2 8,7 mm	 0 3,5 5,3 6,2 8,7 mm	 0 7,6 11,4 13,3 19,0 mm	 0 11,6 17,4 20,3 29,0 mm

			
Operating head types	G41÷53 G71÷75	G61 - G62	G91 - G93
Max actuation speed [m/s]	1,5	1,5	1,0
Z SNAP ACTION 1NO+1NC	 0 21° 32° 74°	 0 21° 32° 74°	 0 10° 20°
Z2 SNAP ACTION 2NC	 0° 10° 30° 74°	 0° 10° 30° 74°	 0° 5° 19°
Z3 SNAP ACTION 2NO	 0° 10° 30° 74°	 0° 10° 30° 74°	 0° 5° 19°
Z4 SNAP ACTION 2NO+2NC	 0° 10° 30° 74°	 0° 10° 30° 74°	 0° 5° 19°
X SLOW ACTION BREAK BEFORE MAKE 1NO+1NC	 0 28° 74°	 0 28° 74°	 48°
X2 SLOW ACTION BREAK BEFORE MAKE 2NC	 0° 26° 74°	 0° 26° 74°	 48°
X3 SLOW ACTION BREAK BEFORE MAKE 2NO	 0° 46° 74°	 0° 46° 74°	 48°
X4 SLOW ACTION BREAK BEFORE MAKE 2NC+2NO	 0° 26° 46° 74°	 0° 26° 46° 74°	 48°

Foot switches

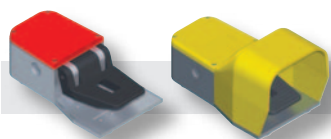

Foot switches page 130

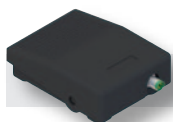

Foot switches MP page 134

Foot switches



Foot switches PS... / PD

Double insulation - Plastic Casing IP65 - Description

APPLICATIONS

Foot switch operated machines such as: shearing machines, spinning machines, spinning lathers, machine tools, wrapping machines, riveting presses, etc.
Foot switches come in five operation formats:

- **Free movement:** contact position follows pedal movement: actuated when the pedal is pushed down, released when pedal is in state of rest.
- **Foot switch locked in neutral position:** same operation as above, after unlocking the pedal with the end of the foot.
- **Foot switch latched in low position:** same operation as free movement, excepted that a state of rest is obtained only after having unlatched the pedal with the end of the foot.
- **Free movement with two-stage actuating force:** two different contact blocks are actuated with a different force on the lever.
- **Foot switch locked in neutral position with two-stage actuating force:** same operation as above, after unlocking the pedal with the end of the foot

DESCRIPTION OF THE SWITCH

- **Dimensions:** 280 x 140 x 138mm.
- **Materials:** **Standard version (IMQ approved):** Base, cover and pedal made of shock resistant ABS material.
Self-extinguishing / VO (IMQ, UL, CSA approved): Base, cover and pedal made of Polycarbonate/ABS-V0.
Metal version / VO-M (IMQ, UL, CSA approved): Cover made in die cast aluminium, base and pedal made of Polycarbonate/ABS-V0.
- **Colour choice:** Grey base; grey, yellow or red cover.
- **Variations:** Grey base, half-red cover. Especially used for emergency stop function.

They comply with the requirements of European Directives (Low Voltage and RoHS) and are conform to European and International Standards.

The CE declaration of these products are available in the download section of website www.comepi.it or by writing to the following email address: tecnico@comepi.it
DDC05 - Foot Switches.

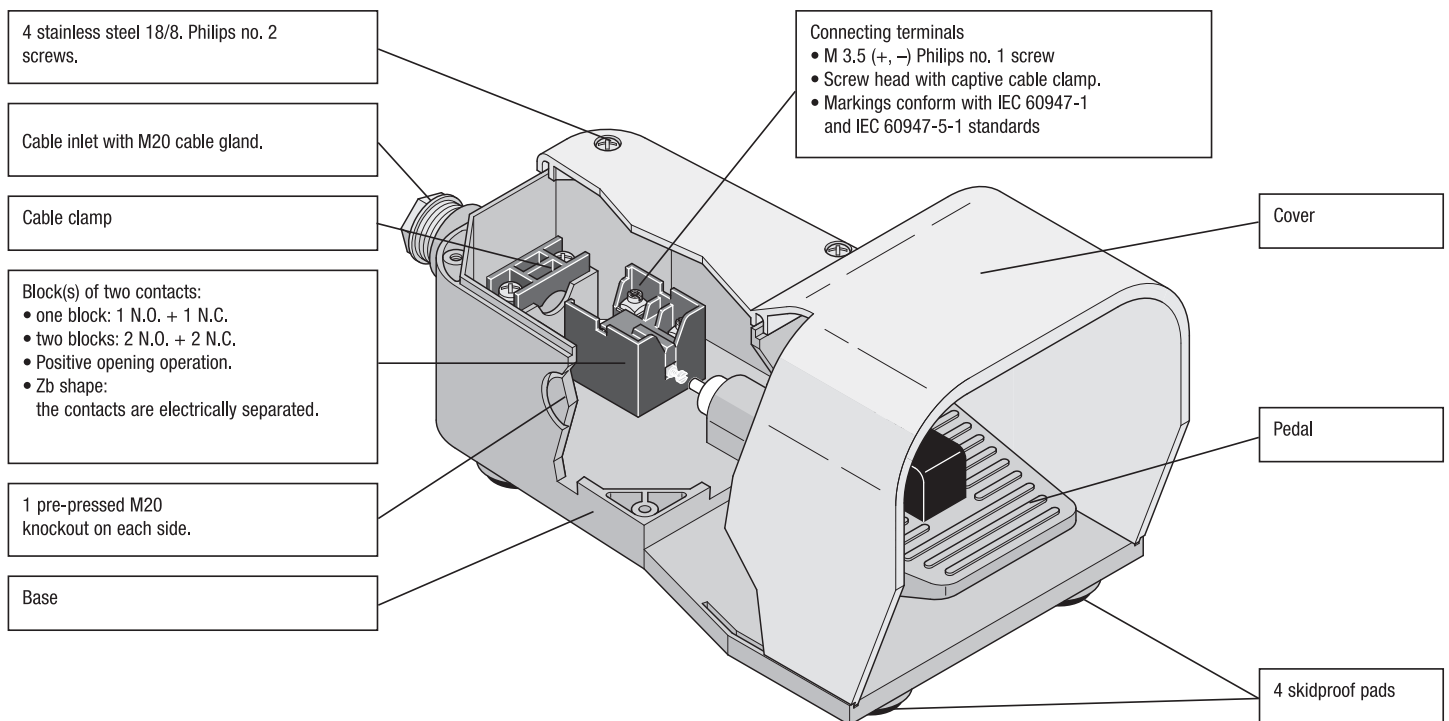

Dimensions (in mm)

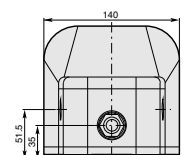
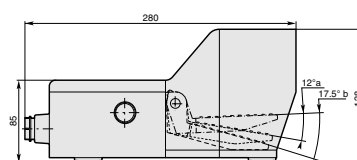

Foot switches PS... / PD

Double insulation - Plastic Casing IP65 - Description

Symbols

Example:

P	S	1	2	1	1
---	---	---	---	---	---

 /

VO

Structure:

P					
---	--	--	--	--	--

 /

--

Type
S = Simple Foot Switch
D = Double Foot Switch

Electrical connection
1 = Pg 16 cable gland
2 = M20 cable gland

Devices
1 = Free movement of the lever
2 = Movement of the lever dependent of the safety device notch
3 = Device to maintain the lever in lowered down position
4 = Free movement with two-stage actuating force
5 = With safety device notch and two-stage actuating force

Contact blocks
1 - One (NO+NC) snap action contact
2 - One (NO+NC) slow action contact
3 - Two (NO+NC) snap action contacts
4 - Two (NO+NC) slow action contacts

Cover material
- = Shock resistant ABS (standard)
VO = UL approved self-extinguishing
VO-M = UL approved with aluminium cover

Cover colour 1 = Yellow / 2 = Grey / 3 = Yellow + Grey (PD series)
4 = Red / 5 = Half red cover / 7 = Half yellow cover / 8 = Half grey cover

DEVICES

1: Free movement of the lever

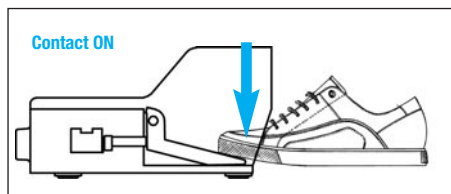
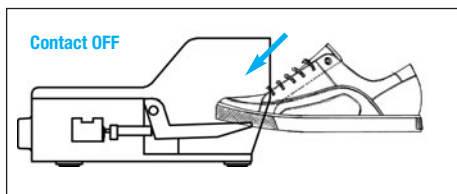

The lever can be actuated without any particular device.

2: Movement of the lever dependent of the safety device notch

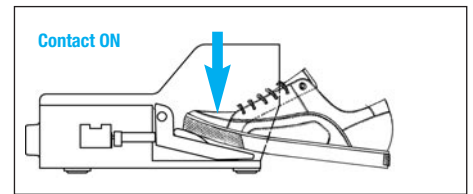
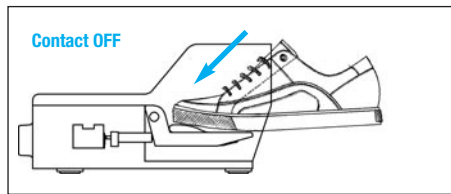
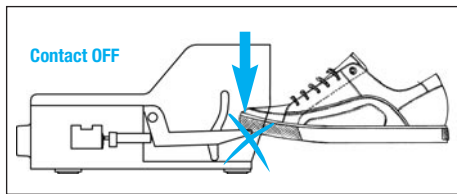

The pedal can be actuated only by lowering the safety lever fully inserting the foot, thus preventing any accidental actuation.

3: Device to maintain the lever in lowered position

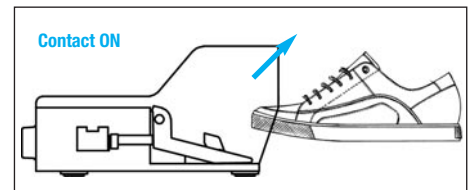
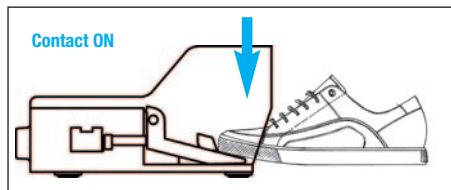
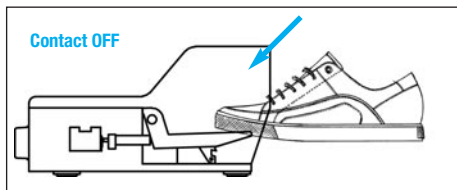

By pushing the lever the contact switches and the lever remains locked in lowered position.

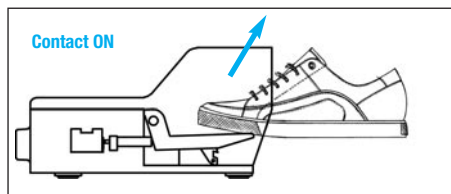
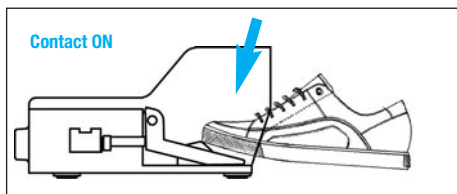

Push the locking device in order to unlock the pedal actuator.
Once you release the lever the contacts return to their initial position.

4: Free movement with two-stage actuating force

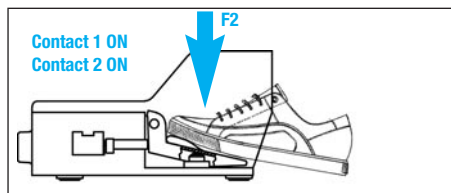
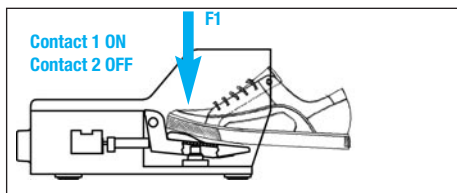

By applying a light pressure F1 on the lever, the first contact block will be actuated while the second keeps in state.
An higher pressure F2 on the lever will switch also the second contact block.

5: With safety device notch and two-stage actuating force

Same as above but the pedal can be actuated only by completely inserting the foot in the device.

Foot switches PS... / PD

Double insulation - Plastic Casing IP65 - Accessories

Carrying Rod Kits

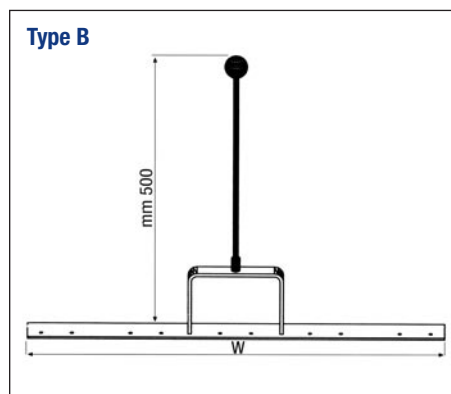
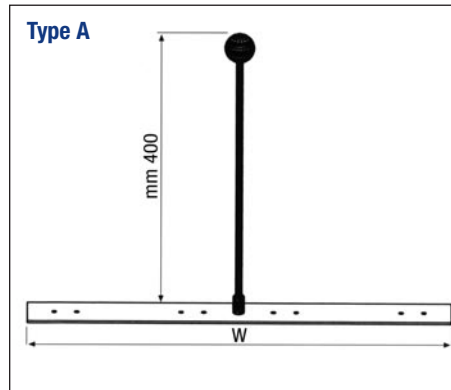
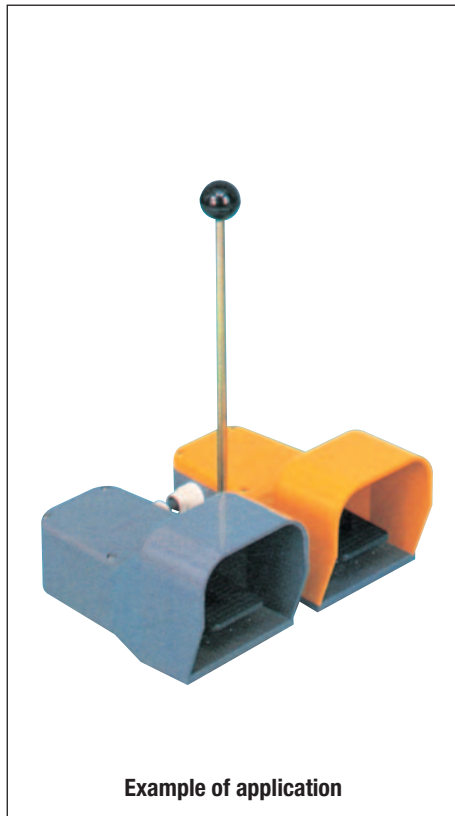

Order Code	Description	W (mm)	Type
PD1000	Max 2 Foot Switches*	225	A
PD1001	Max 3 Foot Switches*	405	B
PD1002	Max 4 Foot Switches*	580	A
PD1003	Max 5 Foot Switches*	745	B

* Foot Switches not included

Note: Each carrying rod kit includes necessary fixing screws and cable glands for the specified number of foot switches.

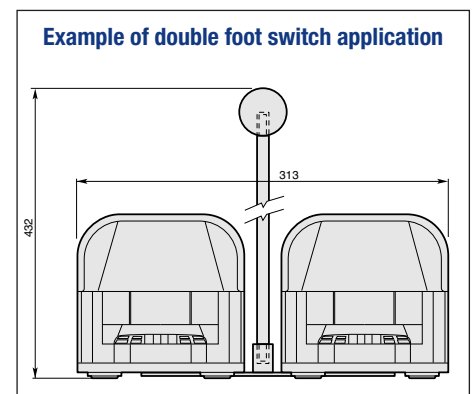

Metal Steel Frame

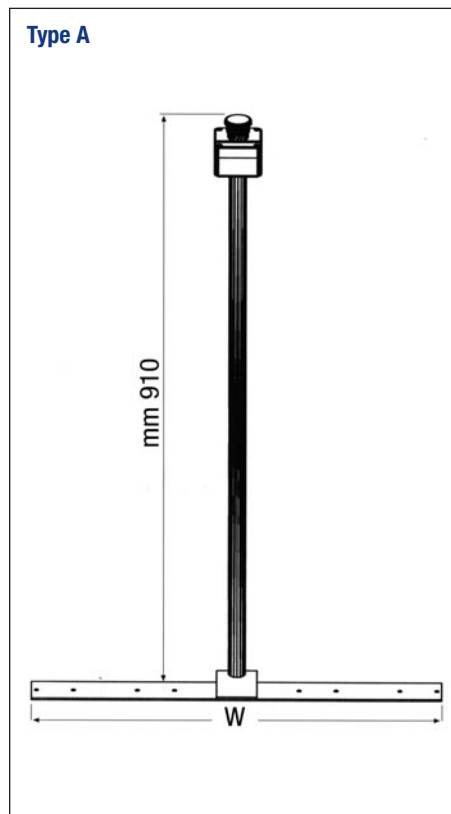

Order Code	Description	W (mm)
GR2025	For 1 foot switch only*	175
GR2026	Max 2 foot switches*	280
GR2027	Max 3 foot switches*	440
GR2028	Max 4 foot switches*	580

* Foot Switches not included

Attention!
Push button and plastic box not included:
please consult our "Control Units 022"
catalog.

Note: Each carrying rod kit includes necessary fixing screws and cable glands for the specified number of foot switches.

Foot switches **PS... / PD**

Two hand control station with support base



GR2030

Aluminium two hand control station

GR2031

Aluminium two hand control station suitable for adjustable support base

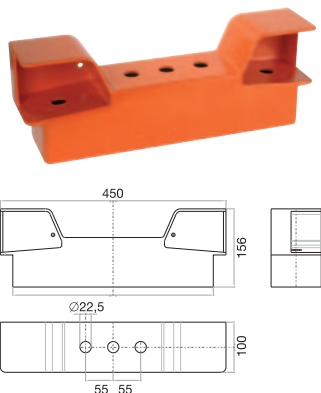

AN003PE

Protection ring

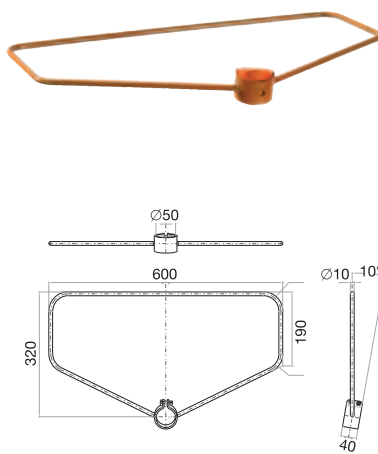

GR2029

Adjustable support base

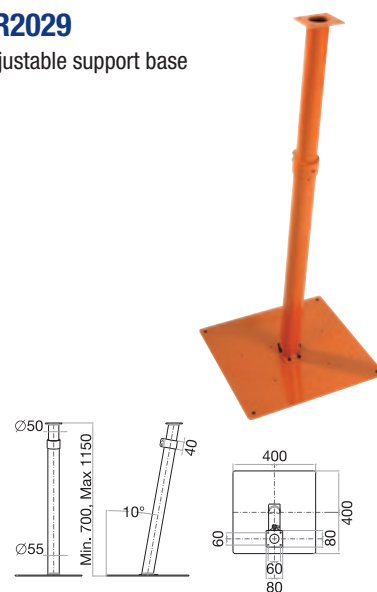

Foot switches **MP...**

Plastic Casing IP65 - Description

APPLICATIONS

Comepi foot switches of the MP series are plastic foot switches in mini design that besides their robust form and technical versatility are specially convincing for their functionality and ergonomic design. They can be applied on foot switch operated machines such as: shearing machines, spinning lathers, machine tools, wrapping machines, riveting presses, etc.

DESCRIPTION OF MP6... MINI FOOT SWITCHES

- **Dimensions:** 100 x 75 x 34 mm.
- **Materials:** cover and base made of self-extinguishing ABS.
- **Colour choice:** black or grey base; black, grey, yellow or red cover.

They comply with the requirements of European Directives (Low Voltage and RoHS) and are conform to European and International Standards. The CE declaration of these products are available in the download section of website www.comepi.it or by writing to the following email address: tecnico@comepi.it DDC05 - Foot Switches.

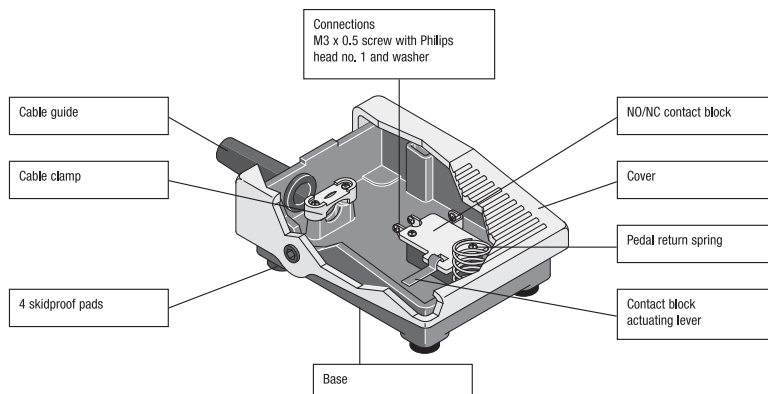

Symbols

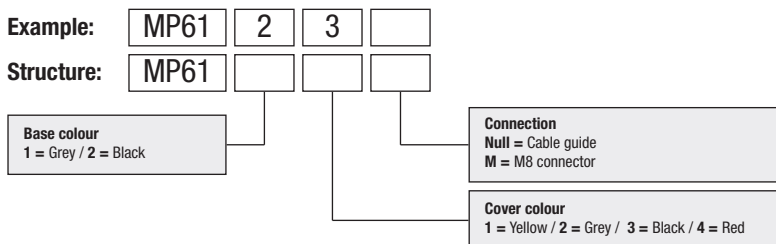

Dimensions (in mm)

NO / NC Contact Block

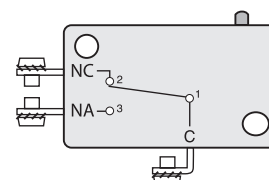
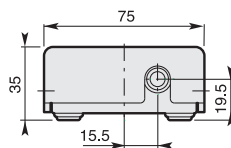
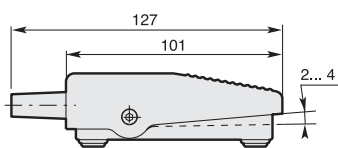

Connection by cable guide

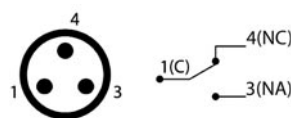
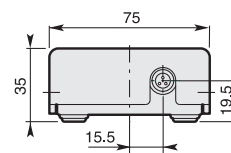
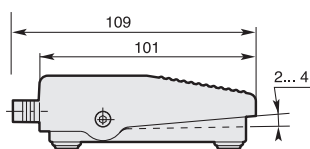

Connection by M8 connector

Accessories



XX3D030SM

3m PVC cable with straight 3 poles M8 female connector

Foot switches

Technical Data

		Mini Foot Switch	Foot Switch with Cover
Standards		EN 61058-1	IEC 60947-5-1
Certifications - Approvals		UL - EAC - UKCA	IMQ - UL and CSA (upon request) - EAC - CCC - UKCA
Air temperature near the device			
– during operation	°C	– 25 ... + 70	– 25 ... + 70
– for storage	°C	– 30 ... + 80	– 30 ... + 80
Climatic withstand		–	according to IEC 60068-2-78 and salty mist according to IEC 60068-2-11
Shock withstand (according to IEC 60068-2-27 and EN 60068-2-27)	g	–	50g (1/2 sinusoidal shock for 11 ms) no change in contact position
Degree of protection (according to IEC 60529 and EN 60529)		IP 40	IP 65
Operating Torque	N.m	1.2	0,25
Operating angle	Degree	2 to 4	15
Cable inlet		Cable guide ø 6 mm; ø max. 8.5	M20

Electrical Data

Rated insulation voltage U_i	V	250 (50 for M8 connector)	690 (according to IEC 60947-1 and EN 60947-1) Degree of pollution 3
Rated impulse withstand voltage U_{imp} (according to IEC 60947-1 and EN 60947-1)	kV	1	6
Conventional free air thermal current I_{th} $\theta < 40\text{ °C}$	A	15 (4 for M8 connector)	10 (according to IEC 60947-1)
Short-circuit protection $U_p < 500\text{ V a.c.}$ - gG (g) type fuses	A	10 (4 for M8 connector)	10
Rated operational current	A	3 (250 V a.c.) for cable guide versions	A 600 (according to UL 508 and CSA C22-2 n° 14)
	A	0.06 (230 V d.c.) for cable guide versions	Q 600 (according to UL 508 and CSA C22-2 n° 14)
AC-15 (according to IEC 60947-5-1)	24 V	A	4 for M8 connector
	240 V	A	–
	400 V	A	–
DC-13 (according to IEC 60947-5-1)	24 V	A	4 for M8 connector
	125 V	A	–
	250 V	A	–
Resistance between contacts	mΩ	30	25
Connecting terminals		M3 x 0.5 screw with Philips head no. 1 and washer	M3.5 (+, –) pozidriv with cable clamp
Positive opening operation (according to IEC 60947-5-1)		–	⊖
Connecting capacity	1 or 2 x mm ²	–	0.75 ... 2.5
Terminal marking		(Refer to contact block page 114)	According to IEC 60947-5-1
Mechanical durability	Millions of operations	10	30
Electrical durability	Operations	100 000	utilization categories AC-15 and DC-13 (Load factor of 0.5 according to curves below)

AC-15 - Snap action

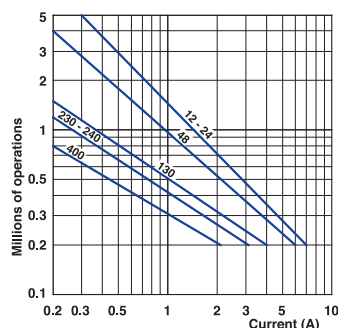

AC-15 - Slow action

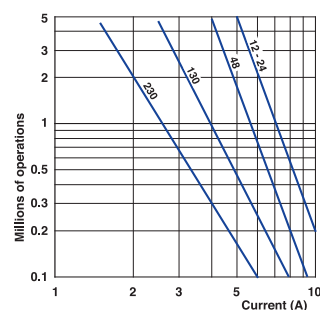

DC-13	Snap action	Slow action
	Power breaking for a durability of 5 million operating cycles	
Voltage	24 V	9.5 W
Voltage	48 V	6.8 W
Voltage	110 V	3.6 W

Notes

A large grid area for taking notes, consisting of a 30x30 grid of small squares. The grid is enclosed in a rounded rectangular border.

COMEPI AROUND THE WORLD

Comepi products are available all over the world, the company supplies 76 countries in 5 continents. Our focus on flexibility translates into the ability to create solutions where the market requires new application needs. Comepi has a network of agents and importers, supported by local distributors. This organization ensures global presence and support.



23899 Robbiate
(Lecco) Italy
Via Novarino 9/L
tel. +039 990 6408
+039 990 6203
comepi@comepi.it
comepi.eu

 **COMEPI**



CAT142-SC1022-PX